



# RIFLE SCOPES

Actual 2024

Our story	3
NEW EPIC 5-25X56 ED SF SIR	4
ZEPHYR product line	5-10
KRONOS product line	11-15
THEMYS product line	16-19
LYNX product line	20-25
List of riflescopes	27
List of reticles	28



## OUR STORY

**Valiant Optics** has been established in the **Czech Republic** in the year 2011. The main idea was and still is the production of high quality riflescopes that can easily compete with other well-known brands on the market. Over time, we have decided to establish our **own factory** with experienced engineers. Thanks to our own inner lens system, we were able to achieve better image clarity and a wider field of view. Since we strive to fully satisfy our customers, we also offer a wide variety of scope accessories.

Our target group is primarily hunters and sports shooters. We currently offer 4 product lines that differ in terms of features and type of use. We also invented a **unique HFT** reticle that meets all the requirements for competitive shooting in this discipline.

Among the main characteristics of our scopes are undoubtedly **high durability** of the main tube, abrasion and water resistance, anodized surface finish, multiple lens coating and, last but not least, reliable functionality of all mechanical parts. Shooters can choose between fixed and variable magnification, different main tubes, with or without illumination, and also among a variety of reticles.

Due to years of experience and rigorous durability tests, our riflescopes are suitable for all shooting categories and disciplines. From air rifle competitions to hunting or shooting long distances with **high-caliber firearms**, with Valiant, there are simply no limits.

# EPIC 5-25x56 ED SF SIR



## Technical specifications

Magnification	5-25x
Main tube diameter	34 mm
Focal Plane	First
Reticle	Etched Glass
Field of view @100 Meters	7.84-3.1 m
Exit Pupil	9.72-2.24 mm
Eye Relief	88-92 mm
Diopter Adjustment	-2.5 / +2.5
Parallax Type	Side Focus
Parallax Correction	20 yds-infinity
Turret Type	Exposed
Click Value @100 Meters	¼ MOA [0.1 Mrad] per Click
Illumination	RED
Mounting Length	145 mm [5.7 in]
Overall Length	367 mm [14.6 in]
Weight	1048 grams

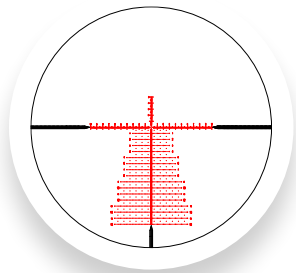

**MIL-F25**  
code:  
VL1001

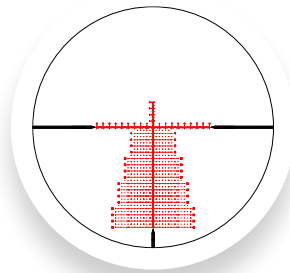

**MOA-F25**  
code:  
VL1002

Valiant Optics proudly presents the **EPIC Series** Rifle Scope. Crafted in collaboration with the renowned EPIC Airguns team, this masterpiece features **5-25 magnification** powered by cutting-edge **ED glass** technology for unparalleled clarity. The **first focal plane** reticle ensures pinpoint accuracy, while robust 34mm tube and 56mm lens deliver exceptional light transmission. With **ultra-precise correction turrets** and rigorous testing in the most demanding conditions, the EPIC Series guarantees unmatched performance when it matters most.

## Parts Included:



Sunshade



Solid flip-up lens covers



Manual



Lens cloth

# ZEPHYR

## ZEPHYR product line

**Premium line** of our riflescopes that meets the highest standards and demands on the market. Reinforced single-piece tube made of aircraft-grade aluminum is filled with nitrogen to prevent fogging. Glass etched reticle is extremely durable and it can withstand the recoil of high caliber firearms. It is also located in the **second focal plane (SFP)** so the magnification has no effect on the size of the reticle. You can choose between 2 reticles and 3 levels of magnification. **Completely redesigned** and easily resettable turrets with **Zero Stop mechanism** are surely a great addition with the second generation of this product series. Since the riflescope is suited mostly for long range shooting, we have equipped it with an adjustable side parallax with range from 10yds to infinity. Side parallax is followed with the illumination knob with **easy and comfortable** manipulation even with gloves. Red color illumination in 11 levels of intensity is always appreciated in low light conditions or if your target does not have enough contrast with the reticle.



Shockproof



30mm 1-piece main tube



Fogproof



Side focus



Water Resistance IP6



Anti-reflective coating



Etched glass reticle



Zero stop resettable turrets



Multi-coated lens



Diopter correction



Multi coated green lens



Zero Stop mechanism



Side focus with illumination



# Zephyr 5-20x50 SF SIR



## Technical specifications

Magnification	5-20 x
Main tube diameter	30 mm
Focal Plane	Second
Reticle	Etched Glass
Field of view @100 Meters	7.4 -1.8 m
Exit Pupil	10-2.5 mm
Eye Relief	105-95 mm
Diopter Adjustment	-2.8 / +2.8
Parallax Type	Side Focus
Parallax Correction	10 yds-infinity
Turret Type	Exposed
Click Value @100 Yards	¼ MOA / 0,1 MRAD per Click
Illumination	RED
Mounting Length	144 mm [5.7 in]
Overall Length	345 mm [13.6 in]
Weight	810 grams

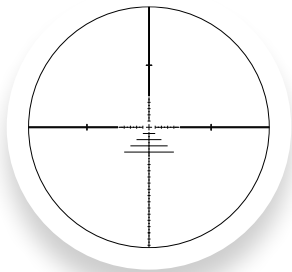

**20x MOA/0.5MIL FBR**

code:  
VL2008 [moa]  
VL2108 [mrad]

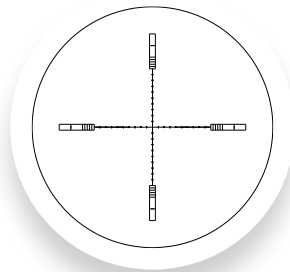

**20x 2MOA Windmill**

code:  
VL2208 [moa]

Most popular magnification from Zephyr series is available with **2 types of reticles**. One-piece main tube with etched glass reticle ensures high durability and gives you the opportunity to mount this scope on **any type of weapon** without limitation of caliber or energy. Exposed turrets are easily resettable and you will surely appreciate **Zero Stop mechanism**.

## Parts Included:



Sunshade



Solid flip-up lens covers



Manual



Lens cloth

# Zephyr 4-16x50 SF SIR



## Technical specifications

Magnification	4-16x
Main tube diameter	30 mm
Focal Plane	Second
Reticle	Etched Glass
Field of view @100 Meters	9.1-2.3 m
Exit Pupil	12-3 mm
Eye Relief	105-95 mm
Diopter Adjustment	-2.8 / +2.8
Parallax Type	Side Focus
Parallax Correction	10 yds-infinity
Turret Type	Exposed
Click Value @100 Yards	¼ MOA per Click
Illumination	RED
Mounting Length	144 mm [5.7 in]
Overall Length	342 mm [13.5 in]
Weight	780 grams

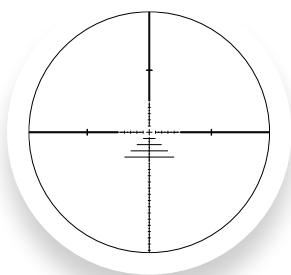

**16x MOA FBR**

code:  
VL2007

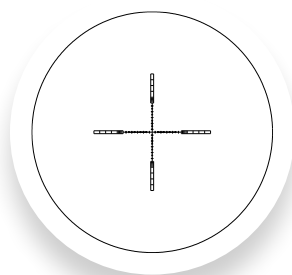

**16x MOA Windmill**

code:  
VL2107

Magnification 4-16 is available with 2 types of **glass etched reticles**. One-piece main tube with 30mm diameter ensures high durability. As all Zephyr scopes also this model is perfect for all shooting disciplines. **Red color reticle illumination** in 11 levels of intensity is very useful in low light conditions. **Zero Stop mechanism** will allow you to save the position of the turret for easy and quick return.

## Parts Included:



Sunshade



Solid flip-up lens covers



Manual



Lens cloth





VALIANT

Mechanical  
Dynamix

Mr. O'Shan

# KRONOS

## KRONOS ARCHERY product line

Kronos archery scopes are intended primarily for **crossbow shooting** and hunting enthusiasts. The **ARC reticle** provides you with a **perfect distance estimate** so that you are always able to hit your target with great precision. Red illumination can be adjusted in 11 levels of intensity. Parallax is fixed at 50 yards. One-piece main tube made of aircraft grade aluminum ensures **great resistance and durability**.



Shockproof



30mm 1-piece main tube



Fogproof



Anti-reflective coating



Water Resistance IP6



Low profiled resettable turrets



Etched glass reticle



Diopter correction



Multi-coated lens



Multi coated green lens



Diopter correction



Low profile capped turrets

# Zephyr 6-24x50 SF SIR



## Technical specifications

Magnification	6-24x
Main tube diameter	30 mm
Focal Plane	Second
Reticle	Etched Glass
Field of view @100 Meters	6-1.5 m
Exit Pupil	8.3-2 mm
Eye Relief	105-95 mm
Diopter Adjustment	-2.8 / +2.8
Parallax Type	Side Focus
Parallax Correction	10 yds-infinity
Turret Type	Exposed
Click Value @100 Meters	¼ MOA per Click
Illumination	RED
Mounting Length	144 mm [5.7 in]
Overall Length	347 mm [13.7 in]
Weight	810 grams

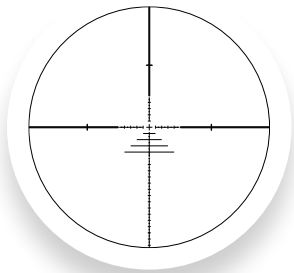

24x MOA FBR

code:  
VL2009

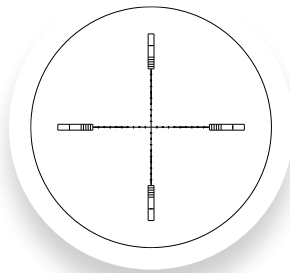

24x 2MOA Windmill

code:  
VL2109

The highest magnification from offer is perfect for long range shooting. Special **anti-reflective coating** ensures no light transmission defects while aiming. Side focus wheel is designed for **quick target distance adjustment**. Zephyr scopes are tested in extreme conditions so that you can rely on them even under the **most difficult conditions**.

## Parts Included:



Sunshade



Solid flip-up lens covers



Manual



Lens cloth

# Kronos 4x40 SIR



### Technical specifications

Magnification	4x
Main tube diameter	30 mm
Focal Plane	Second
Reticle	Etched Glass
Field of view @100 Meters	10.5 m
Exit Pupil:	10 mm
Eye Relief	96.46 mm
Diopter Adjustment	-3 / +3
Parallax Type	Fixed
Parallax Correction	50 yds
Turret Type	Exposed
Click Value @100 Yards	1/2 MOA per Click
Illumination	RED
Mounting Length	110 mm [4.3 in]
Overall Length	250 mm
Weight	485 grams

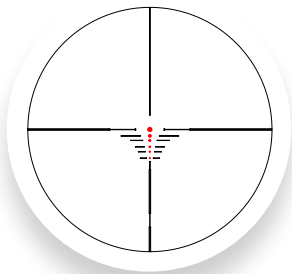

### ARC

code:  
VL3002

Get this scope to be ready for your hunt! **Outstanding clarity** and sharp image will support you all the time. Low profile turrets are easy to reset with metal screw and you will hear each click you make. **Reticle illumination** will help you in low-light conditions. Fixed parallax is set to 50 yards. Designed especially for **crossbow shooters**.

### Parts Included:



Solid flip-up lens covers



Lens cloth



Manual

# KRONOS



Shockproof



30mm 1-piece main tube



Fogproof



Anti-reflective coating



Water Resistance IP6



Low profile resettable turrets



Etched glass reticle



Diopter correction



Multi-coated lens

## KRONOS TACTICAL product line

The increasing demand for hunting and tactical riflescopes led us to produce a **completely new model** that was able to satisfy the needs of shooters without unnecessary compromises in the quality of workmanship. Model 1-6x24 is the **most compact riflescope** from our offer and we are very satisfied with the outcome.



Multi coated green lens



Diopter correction



Low profile tactical turrets

# Kronos 1-6x24 SIR



## Technical specifications

Magnification	1-6x
Main tube diameter	30 mm
Focal Plane	Second
Reticle	Etched Glass
Field of view @100 Meters	37.5-6.6 m
Exit Pupil:	4-11.2 mm
Eye Relief	85-88.5 mm
Diopter Adjustment	-2.75 / +2.75
Parallax Type	Fixed
Parallax Correction	100 yds
Turret Type	Exposed
Click Value @100 Yards	1/10 MOA per Click
Illumination	RED
Mounting Length	177 mm [6.96 in]
Overall Length	260 mm [10.2 in]
Weight	480 grams

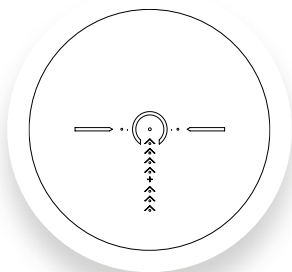

### 6x MIL Tactical

code:  
VL3001 [mrad]

One of the most compact models from our offer. Magnification 1-6x is a perfect choice for hunting at shorter distance or **tactical shooting**. Parallax is fixed at 100 yards. All Kronos riflescopes can be fitted on any rifle without limitation of caliber or energy. One-piece main tube made of **aircraft grade aluminum** ensures great resistance and durability.

## Parts Included:



Solid flip-up lens covers



Lens cloth



Manual



# THEMYS

## THEMYS product line

We are extremely proud of the second generation of our Themys riflescopes. Choose between the versatile Windmill, FBR or above all else our unique HFT reticle, which was invented in close cooperation with the world champion in the **Hunter Field Target discipline**. We continue to receive 100% positive feedback from sports shooters around the world. Exposed turrets with an extremely well made click system is something you can't go wrong with. **Crystal clear vision** with a wide field of view is guaranteed because the technology and tube structure are the same as with our flagship product line Zephyr.



Shockproof



Anti-reflective coating



Fogproof



Low profile turrets



Water Resistance IP6



Diopter correction



Etched glass reticle



Multi-coated lens



Multi coated green lens



Diopter correction



Low profile turret



# Themys 3-12x42 SF Compact



## Technical specifications

Magnification	3-12x
Main tube diameter	30 mm
Focal Plane	Second
Reticle	Etched Glass
Field of view @100 Meters	13-3.2 m
Exit Pupil	13.86-3.41 mm
Eye Relief	80-89 mm
Diopter Adjustment	-2.5 / +2.5
Parallax Type	Side Focus
Parallax Correction	10 yds-infinity
Turret Type	Exposed
Click Value @100 Yards	¼ MOA / 0,1 MRAD per Click
Illumination	N.A.
Mounting Length	178 mm [7 in]
Overall Length	273 mm [10.7 in]
Weight	630 grams

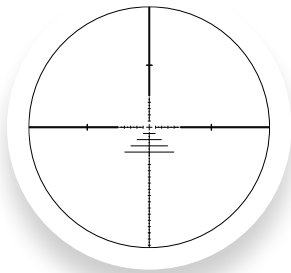

### 12x MOA FBR

code:  
VL4004 [moa]

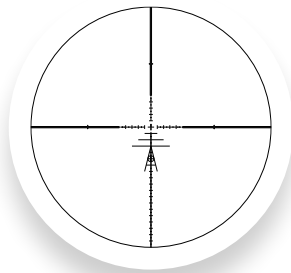

### 12x MIL HFT

code:  
VL4104 [mrad]

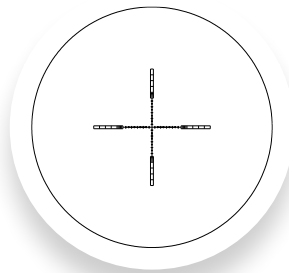

### 12x MIL Windmill

code:  
VL4204 [mrad]

The 30mm main tube and compact dimensions are great for use on airguns or compact tactical rifles. One of the most prominent features are the new and reworked turrets with **Zero-Stop mechanism**. The adjustment graduation is in **1/10 MRAD** (one click equals 1cm at 100 cm). **Glass etched reticle** is capable of withstanding recoils of high calibre firearms.

## Parts Included:



Solid flip-up lens covers



Manual



Lens cloth

# Themys 10x32 SF Compact



## Technical specifications

Magnification	10 x
Main tube diameter	30 mm
Focal Plane	Second
Reticle	Etched Glass
Field of view @100 Meters	4 m
Exit Pupil	3.35 mm
Eye Relief	85 mm
Diopter Adjustment	-2.5 / +2.5
Parallax Type	Side Focus
Parallax Correction	10 yds-infinity
Turret Type	Exposed
Click Value @100 Yards	0.1 MRAD per Click
Illumination	N.A.
Mounting Length	138 mm [5.43 in]
Overall Length	273 mm [10.74 in]
Weight	560 grams

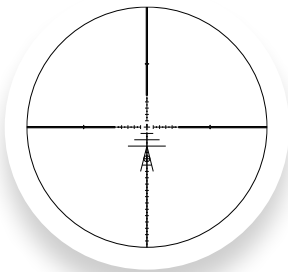

## 10x MIL HFT

code:  
VL4003 [mrad]

The fixed magnification of this model is praised by **Hunter Field Target** enthusiasts who mostly engage targets at short to medium ranges. The turrets are large enough to be used effectively while wearing gloves, and each click is distinct and clearly audible. The **Zero Stop** function is also a big advantage.

## Parts Included:



Solid flip-up lens covers



Manual



Lens cloth



# LYNX SF

## LYNX SF product line

Lynx SF scopes are without a doubt our **best sellers**. They are suitable for PCP airguns and low caliber firearms, but they were successfully tested also on higher recoil weapons. **One-piece main tube** with wired reticle ensures great durability. All Lynx riflescopes are fitted with **Mil-Dot** reticle, diopter correction, adjustable objective and illumination in 11 levels of intensity. All lenses are coated with a special anti-reflective layer. VL5301 and VL5401 models are equipped with **Push-Pull locking turrets** which have the option of easy zeroing. Click system of each turret is very noticeable and accurate. Solid flip-up lens covers and mounts for 11 mm dovetail are included in the box.



Shockproof



30mm 1-piece main tube



Fogproof



Anti-reflective coating



Water Resistance IP5



Push-pull locking resettable turrets



Wired reticle



Diopter correction



Multi-coated lens



Multi coated green lens



Push-pull zero resettable turrets



Side focus with illumination

# Lynx 6-24x50 SF SIR



## Technical specifications

Magnification	6-24x
Main tube diameter	30 mm
Focal Plane	Second
Reticle	Wire
Field of view @100 Meters	5.3-1.3 m
Exit Pupil	8.42-2 mm
Eye Relief	110-90,8mm
Diopter Adjustment	-2.2 / +2.2
Parallax Type	Side Focus
Parallax Correction	10 yds-infinity
Turret Type	Exposed
Click Value @100 Yards	¼ MOA per Click
Illumination	RED
Mounting Length	155,6 mm [6.1 in]
Overall Length	357 mm [14.1 in]
Weight	730 grams

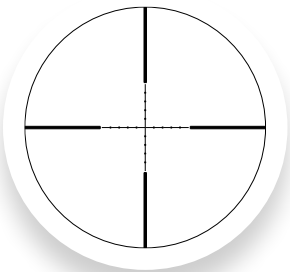

24x Mil-Dot

code:  
VL5301

## Parts Included:



Mounts



Solid flip-up  
lens covers



Manual



Lens cloth

Highest magnification from Lynx series is perfect for **long range shooting**. Easily resettable push-pull locking turrets are very well designed and you will hear every click very clearly. To zero your scope, simply use the silver metal screw in the middle of each turret. **30mm one-piece main tube** made of aircraft grade aluminum. Wired reticle makes this scope perfect for sport shooting with PCP airguns and low caliber firearms.



# Lynx 4-16x50 SF SIR



## Technical specifications

Magnification	4-16x
Main tube diameter	30 mm
Focal Plane	Second
Reticle	Wire
Field of view @100 Meters	8.2-2.1 m
Exit Pupil	12.6-3 mm
Eye Relief	103.4-90.4 mm
Diopter Adjustment	-2.2 / +2.2
Parallax Type	Side Focus
Parallax Correction	10 yds-infinity
Turret Type	Exposed
Click Value @100 Yards	¼ MOA per Click
Illumination	RED
Mounting Length	150 mm [5.9 in]
Overall Length	353 mm [13.9 in]
Weight	715 grams

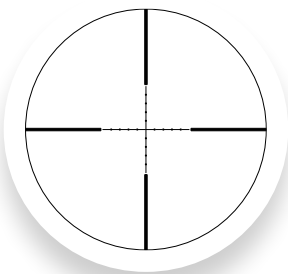

16x Mil-Dot

code:  
VL5401

## Parts Included:



Mounts



Solid flip-up  
lens covers



Manual



Lens cloth

Medium and long range shooting are easily achievable with **4-16x magnification**. **Push-pull locking turrets** are very well designed and you will hear every click very clearly. To zero your scope, simply use the silver metal screw in the middle of each turret. 30mm one-piece main tube is made of **aircraft grade aluminum**. Wired reticle makes this scope perfect for sport shooting with PCP airguns and low caliber firearms.

# LYNX AO

## LYNX AO product line

This series guarantees **excellent quality** at a reasonable price. Great choice for PCP airguns and low caliber firearms. One-piece main tube with wired reticle ensures great resistance. All Lynx riflescopes are fitted with **Mil-Dot reticle**, diopter correction, adjustable objective and red illumination in 11 levels of intensity. All lenses are coated with a special anti-reflective layer. Model VL5201 is equipped with exposed **low profiled turrets** with front adjustable objective. Click system of each turret is very noticeable and accurate. Solid flip-up lens covers and mounts for 11 mm dovetail are included in the box.



Shockproof



Anti-reflective coating



Fogproof



Low profile turrets



Water Resistance IP5



Diopter correction



Wired reticle



Multi-coated lens



Multi coated green lens



Diopter correction



Low profile turret



# Lynx 3-9x40 AO SIR



## Technical specifications

Magnification	3-9x
Main tube diameter	25.4 mm
Focal Plane	Second
Reticle	Wire
Field of view @100 Meters	11.2-3.5 m
Exit Pupil	13.55-4.35mm
Eye Relief	108.5-95mm
Diopter Adjustment	-2.2 / +2.2
Parallax Type	Adjustable Objective
Parallax Correction	10 yds-infinity
Turret Type	Exposed
Click Value @100 Yards	¼ MOA per Click
Illumination	RED
Mounting Length	127 mm [4.92 in]
Overall Length	322 mm [12.6 in]
Weight	495 grams

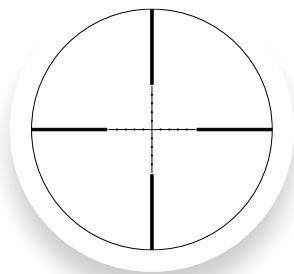

9x Mil-Dot

code:  
VL5201

## Parts Included:



Mounts



Solid flip-up  
lens covers



Manual



Lens cloth

Surely one of the best rifle scopes on the market in its price range. One-piece main tube is made of **aircraft grade aluminum**. Wired reticle makes it suitable for sport and hobby shooting with PCP airguns and low caliber firearms, for example .22LR. **Diopter correction** and adjustable front objective parallax will help you to always get crystal clear image. Exposed low-profile turrets are **easily resettable**.



# RIFLESCOPES



## List of riflescopes

Series	Model	Tube	Reticle	Field of view @100 Meters	Exit Pupil	Eye Relief	Diopter Adjustment	Parallax Type	Parallax Correction	Focal Plane	Click Value	Illumination	Elevation Travel MOA / MRAD	Windage Travel MOA / MRAD	Overall Length	Weight
Zephyr	6-24x50	30 mm	Etched Glass	6 - 1.5 m	8.3 - 2 mm	105 - 95 mm	-2.8 / +2.8	SF	10 yds - infinity	Second	¼ MOA	RED	40 MOA	40 MOA	347mm [13.7 in]	800 g
Zephyr	5-20x50	30 mm	Etched Glass	7.4 - 1.8 m	10 - 2.5 mm	105 - 95 mm	-2.8 / +2.8	SF	10 yds - infinity	Second	¼ MOA 0.1 MRAD	RED	40 MOA 11.6 MRAD	40 MOA 11.6 MRAD	345 mm [13.6 in]	800 g
Zephyr	4-16x50	30 mm	Etched Glass	9.1 - 2.3 m	12 - 3 mm	105 - 95 mm	-2.8 / +2.8	SF	10 yds - infinity	Second	¼ MOA	RED	40 MOA	40 MOA	342 mm [13.5 in]	780 g
Kronos	4x40	30 mm	Etched Glass	10.5 m	10 mm	96.46 mm	-3 / +3	Fixed	100 yds	Second	1/2 MOA	RED	70 MOA	70 MOA	250 mm [9.8 in]	485 g
Kronos	1-6x24	30 mm	Etched Glass	37.5 - 6.6 m	4 - 11.2 mm	85 - 89 mm	-2.75 / +2.75	Fixed	100 yds	Second	0.1 MRAD	RED	20.3 MRAD	20.3 MRAD	260 mm [10.2 in]	480 g
Themys	3-12x42	30 mm	Etched Glass	13 - 3.2 m	13.86 - 3.41 mm	80 - 89 mm	-2.5 / +2.5	SF	10 yds - infinity	Second	¼ MOA 0.1 MRAD	N.A.	40 MOA 11.6 MRAD	40 MOA 11.6 MRAD	273 mm [10.7 in]	630 g
Themys	10x32	30 mm	Etched Glass	4 m	3.35 mm	85 mm	-2.5 / +2.5	SF	10 yds - infinity	Second	0.1 MRAD	N.A.	11.6 MRAD	11.6 MRAD	273 mm [10.7 in]	560 g
Lynx	6-24x50	30 mm	Wire	5.3 - 1.3 m	8.42 - 2 mm	110 - 91 mm	-2.2 / +2.2	SF	10 yds - infinity	Second	0.125 MOA	RED	30 MOA	30 MOA	353 mm [13.9 in]	730 g
Lynx	4-16x50	30 mm	Wire	8.2 - 2.1 m	12.66 - 3.07 mm	103 - 90 mm	-2.2 / +2.2	SF	10 yds - infinity	Second	¼ MOA	RED	40 MOA	40 MOA	357 mm [14.1 in]	715 g
Lynx	3-9x40	25.4 mm	Wire	11.2 - 3.5 m	13.55 - 4.35 mm	109 - 95 mm	-2.2 / +2.2	A0	10 yds - infinity	Second	¼ MOA	RED	40 MOA	40 MOA	322 mm [12.6 in]	495 g

# RETICLES



## List of reticles

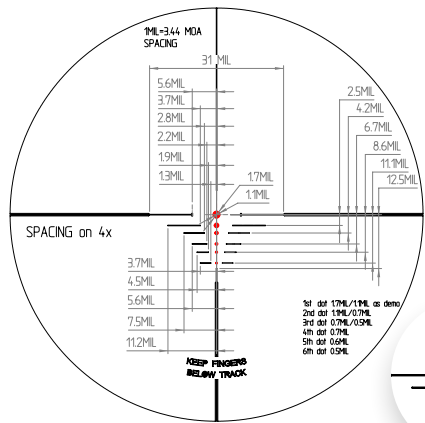

ARC

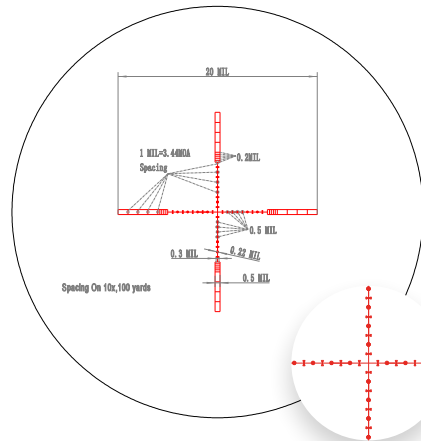
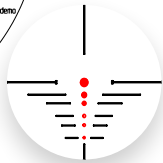

10x 1/2 Windmill

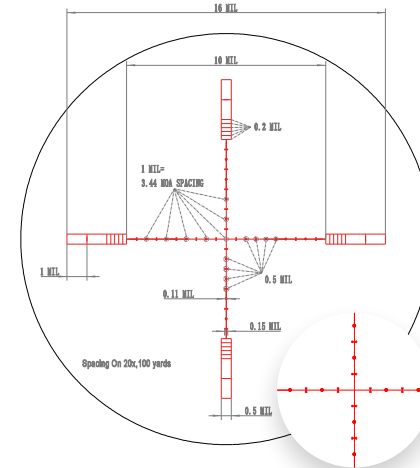
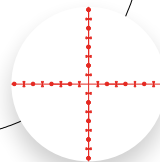

20x 1/2 Windmill

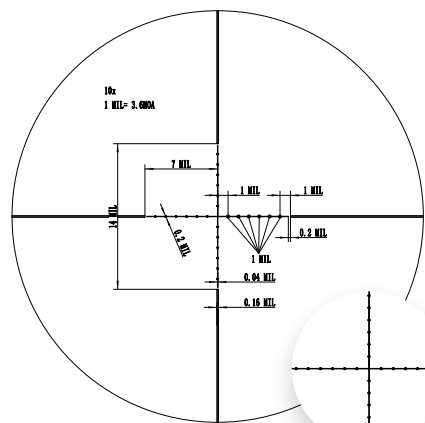
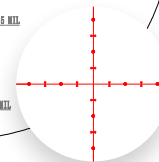

Mil-Dot

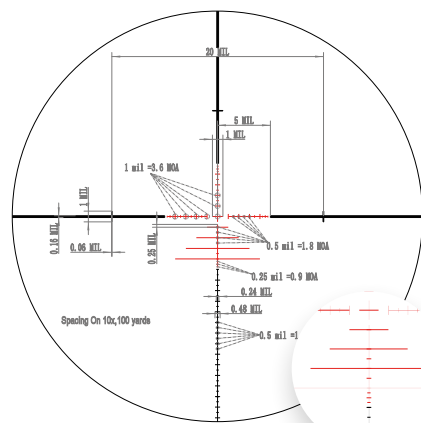
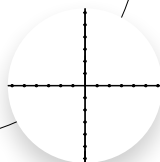

FBR

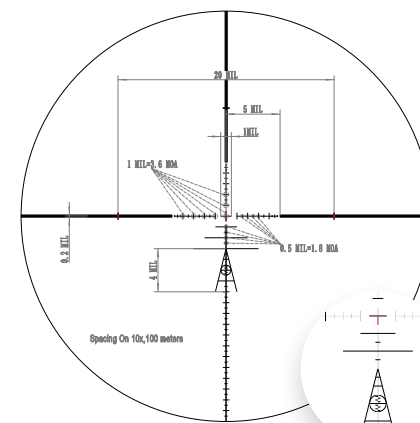
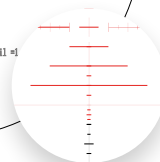

HFT

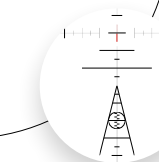



[www.valiant-optics.com](http://www.valiant-optics.com)

**BULLET PROJECT s.r.o.**

U Staré elektrárny 291/11, 710 00 Ostrava, Czech Republic

**Tel.:** +420 602 243 956

**E-mail:** [sales@valiant-optics.com](mailto:sales@valiant-optics.com)