



TOTAL SOLUTIONS PROVIDER OF  
GLUING & INSPECTION SYSTEMS TO THE

# CORRUGATED INDUSTRY



**VALCO MELTON**

Adhesive Dispensing & Quality Inspection Systems

# CONTROLS

## ONE-VIEW



- Available in 10" and 22" screen dimensions
- Acts as central display for multiple MCP-4J, MCP-8 and/or MCP-8i units for flexo-folder-gluer and multi-point gluer applications for up to 48 valves
- Supports contact and non-contact applications
- Supports multiple sensors for flexo-folder-gluer applications as well as multi-point gluer applications
- Familiar ClearVision gluing interface and easy connectivity
- Job storage up to 1000 jobs
- OEM communication
- Simple glue station configurability
- Right- and left-hand machine screen configurations
- New sensor screens with glue, flap length and barcode inspection as well as sensor signal diagnostics

## MCP-8/MCP-8I



- Use with 10" and 22" OneView screens or connect one or more to any ClearVision system to display gluing screens on the 'gluer' tab of the ClearVision system
- Pneumatic and electronic pressure control outputs
- 8 valves, 8 scanners (MCP-8) or 4 valves, 4 scanners, 3 sensors (MCP-8i)
- Supports contact and non-contact gluing stations
- Jam preventer (4 or 8 Channel)
- Job storage (100)
- Batch count
- Auto-configuring voltage 90-240VAC
- Internal/external pressure control
- Inch/Metric
- 4.5" color touch-screen
- Backup/restore to/from external media
- OEM communication
- Scanner lockout
- Auto-glue mode
- Pulse-purge
- Stitched patterns and jog on restart

### In addition to the above features, the MCP-8I includes:

- 4-valves, 3-inspection sensors, 1 marking valve
- Supports CGS-40 and CGS-40S as well as AS-304 glue inspection sensors and laser barcode readers
- Scanner lockout
- Drives pneumatic rotary and linear ejectors
- MCP-8/8I units supplied with OneView screens will have the front panel screen and keypad replaced with a blank cover plate

## VCX/OT-120



- Up to 16 channels in modules of 4 in any combination of sensors and valves
- Compatible with all glue station types
- Jam preventer (up to 16 channels)
- Auto-configuring voltage 90-240VAC
- Internal pressure control (up to 4)
- External pressure control (up to 4)
- Easily recognized icon-based access to gluing inspection
- Job storage (1000)
- Inch/metric
- 12" Remote-mount color touchscreen
- Data sharing with BoxChek 7
- OEM communication
- Auto-glue mode
- Pulse-purge
- Stitched patterns and jog on restart
- The VCX base can fire up 16 valve per unit and 2 VCX base units can be connected to an OT-120

## MCP-4J



- Use with 10" and 22" OneView screens or connect one or more to any ClearVision system to display gluing screens on the 'gluer' tab of the ClearVision system
- 4-Valves, 4-Scanners
- Compatible with all glue station types except non-contact stations
- Jam preventer (4 channel)
- Auto-configuring voltage 90-240VAC
- Internal/external pressure control
- Job storage (100)
- Inch/metric
- LED display plus push-button overlay
- USB port for system backups and software updates.
- Batch count
- Displays gluer screen on any ClearVision system
- Auto-glue mode

## MCP-12/OT-12



- 4-Channel gluing and inspection
- Compatible with contact glue stations
- 4-Channels Jam
- 115VAC or 230VAC
- 6" remote-mount color touch-screen
- Internal pressure control
- Inch/metric
- Easily recognized icon-based access to gluing inspection
- USB port for software updates
- Alarm/relay outputs
- OEM communication (RS-232 only)
- Auto-glue mode

# CONTACT GLUE STATIONS

## BOARDRUNNER™

The BoardRunner contact gluing station features a quick change option for top-down or bottom-up gluing. It is also equipped with a high performance, high speed all electric model 900 series valve. The impact resistant carbide plunger tip and engineered ceramic seat of the 900 valve leads the industry in durability with over 250 million cycles before major maintenance is required.



**BoardRunner can be easily switched from top-down/ bottom-up for inside or outside glue joints**

- Adjustable gap
- Adjustable weight relief air pressure
- Accepts applicator heads for glue patterns up to 2.5" wide (64mm) in jumbo format or in dual jumbo format up to 6" wide (150mm)
- Patented floating head design offers proper contact without impeding product flow
- Available as jumbo & dual-valve jumbo
- Integrated photo-eye





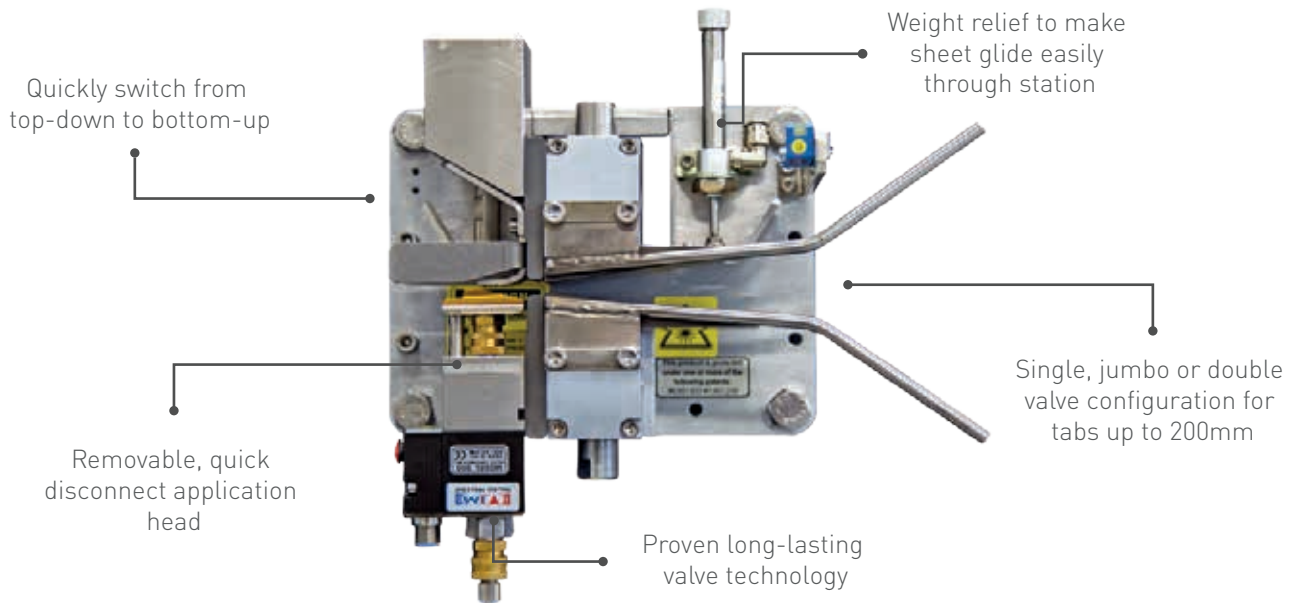

## COMBI-STATION™

- 366 pneumatic glue valve (24V or 12V)
- Valves can be quickly replaced with quick-on modules
- Station can run bottom-up and top-down
- Adjustable spring pressure
- Available as jumbo



## V-75/VO-700

- 366 pneumatic glue valve (24V or 12V)
- Adjustable spring pressure
- Accepts applicator heads for glue patterns up to 1.75" wide (45mm) or 3.75" wide (95mm) in jumbo format
- Available as jumbo
- Must be rebuilt for top-down/bottom-up contact glue station



# NON-CONTACT GLUE STATIONS

## 3NCR™/4NCR™

The 3NCR Tri-Valve glue station eliminates the need to invest in gluing equipment for both sides of the machine. Engineered for maximum versatility, the 3NCR non-contact reversible station can quickly and easily be set bottom-up or top-down. The reversible feature allows the station to run for either inside or outside glue boxes with only the pull of a ring.

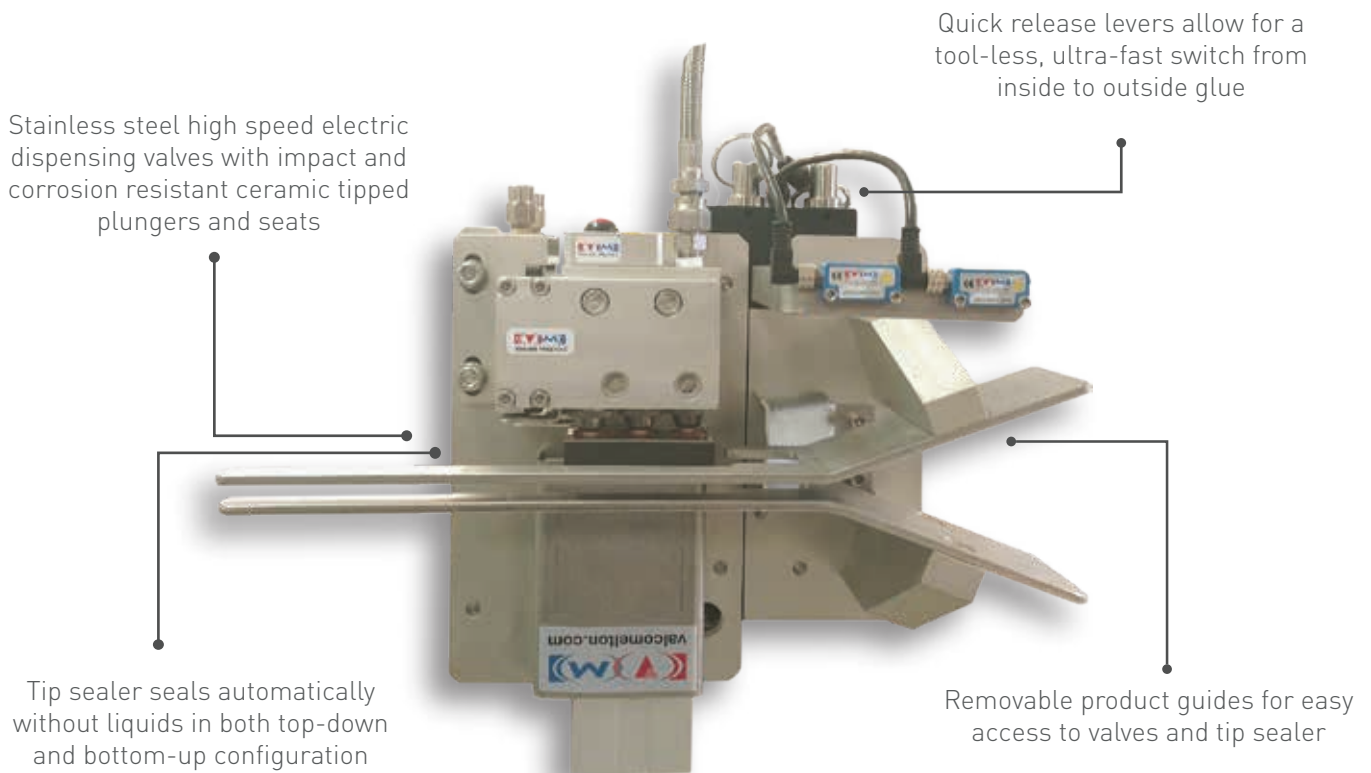

- 524 electric high-speed glue valves (up to 4)
- Quick reversing with two easy-hold levers
- Low restriction nozzles
- Tip sealer for top-down/bottom-up
- Adjustable product guides
- Adjustable delay to park glue station
- Can run in auto-glue mode on tab side
- Supports stitch and jog modes
- Staggered starts and glue lengths to match tab angles
- Tip sealer pad requires no liquid



**3NCR can be easily switched from top-down/ bottom-up**

## 3NC™/4NC™

- Can run in auto-glue mode
- Supports stitch and jog modes
- Tip sealer technology for valves
- Low restriction nozzles
- 524 electric glue valves (up to 4)
- Supports 3 beads on 1/4" centers 3/4 wide pattern or 19mm wide pattern
- Staggered glue lengths and pattern starts to match tab angles
- Adjustable product guides

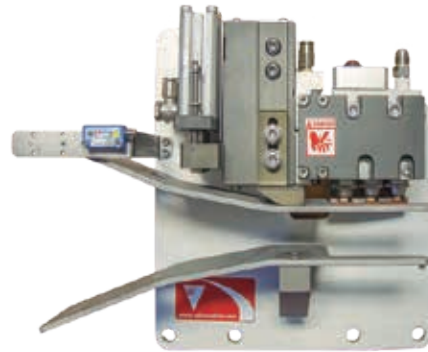

**WATCH VIDEO**  
CONTACT &  
NON-CONTACT  
GLUING STATIONS



## THE TOTAL PACKAGE

GLUING & INSPECTION FROM  
ONE SINGLE PROVIDER

# PUMPING SYSTEMS & BALANCING REGULATORS

## DD-1

- Trusted reliability of a 1:1 diaphragm pump
- Electronic shifting
- New intelligent glue level control, SLOW MODE, and pump stroke counting features
- High flow rate
- Suction from totes, drums, and pails
- 1/2 NPT and 1/2 BSPP inlet/outlet fittings
- 24VAC source from Valco Melton controls or optional transformer box
- Wall mount, lid mount, or drum mount



## EPP-9

- High flow-rate 9:1 piston pump
- Low glue level detection with optional probe
- Electronic reversing
- Intelligent SLOW MODE feature prevents high cycle rates that occur during priming or when adhesive supply is blocked or depleted (dry cycling)
- Available as single-acting
- Advanced seal technology for 4 times the life of previous piston pumps
- 24V power supply are available 115/230VAC transformer
- Easy to clean and install
- In excess of 50 bar available glue pressure



## NEW

- Integrated pressure transducer available
- Easy-connect level probe on MCP-4J and MCP-8 ranges of controls
- Optional over/under pressure warning

## PFRM-6

- Complete assembled package, 14:1 pump, filter, 6:1 balancing regulator, 4-port manifold
- Shaft/seal cartridge for fast and simple repair
- Drum mount, wall mount, and pail mount options





## 1:1, 3:1, 6:1 BALANCING REGULATOR

- Pressure balancing regulator - relieves excessive pressure that occurs during high speed stops
- Ultra-precise and fast pressure control
- No shaft seals
- Easy rebuild
- Various ratios for specific application demands
- Rolling diaphragm design for frictionless movement



## 832 1:1 REGULATOR

- Stainless steel construction
- Air-piloted
- Easy manual adjust



## CENTRAL GLUING SYSTEMS

- Pre-assembled, Dual Suction and pump system to supply an entire plant with 7 bar (100psi) glue pressure at each converting machine
- Makes use of two reliable, electronic-shifting DD-1 pumps in a redundant system to guarantee constant glue pressure
- Combine with low-level detection to have audible and visual alarm of empty glue container
- Ball valves on suction and output sides to select supply pump
- Large-scale filtration with air purge valve on each pump
- Suction kit with quick-coupling disconnect from container
- Match with appropriately-sized piping in ceiling and drops to each machine



PERFECT PRESSURE  
EVERY TIME

vacuumeltor.com

# TAPER/STITCHER CONVERSION KITS

## HOT OR COLD GLUING PACKAGE

Valco Melton offers hot melt and cold glue taper or stitcher conversion kits for General and Universal Tapers. These kits add flexibility and cut costs by enabling you to glue a manufacturer's glue tab style box rather than tape or stitches. The components of the kits include brackets, applicator valves & heads, a pressurized glue source (melt tank with pump for hot melt systems), and solenoid-operated air valve that ties into the existing limit switch for the taping mechanism.

- Eliminate costly tape and stitches, associated storage, and handling problems
- Increase belt speed for more production
- Improve quality with stronger bonds
- Operate with coated and non-coated board stock

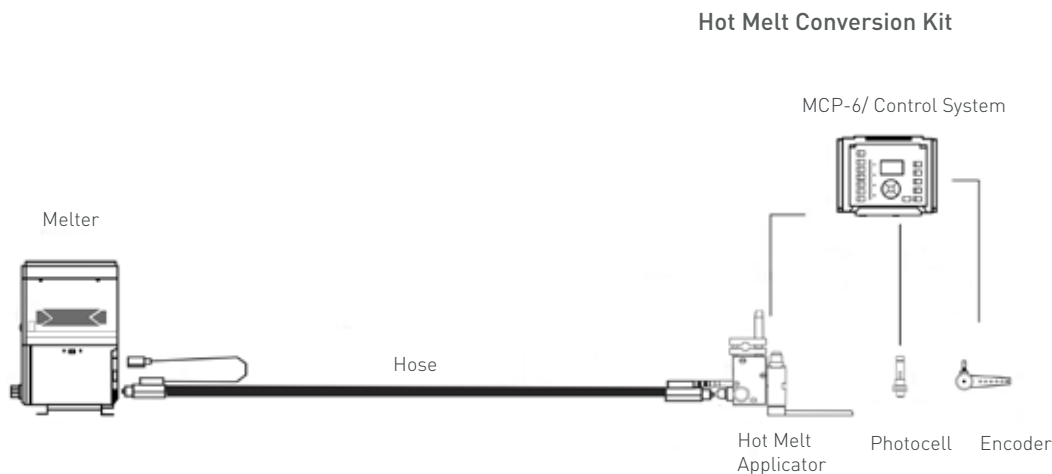
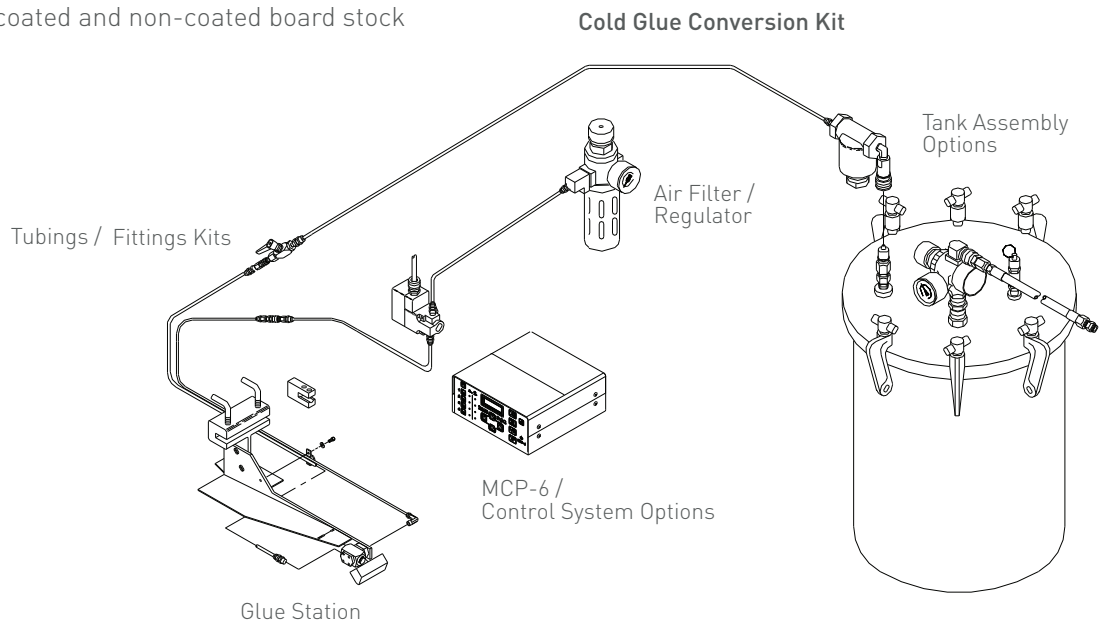

# TAB TRIM REMOVERS

## TR500M

- Eliminate scrap issues such as false system starts and unglued boxes
- Total weight: (8.8 lbs) 4kg
- Electric or Pneumatic versions available

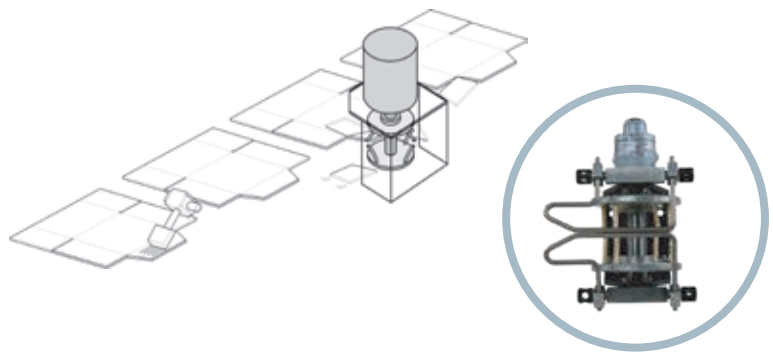

## TR500ME ELECTRIC TRIM REMOVAL SYSTEM

- Eliminate tab trim and scrap
- Automatically speeds up when it detects products running on the machine
- Mounting bracket package included
- Two high-speed, 4000 rpm motors
- Long lasting high-wear laminated blade sets
- Includes mounting hardware, lightweight aluminum extrusion

**WATCH VIDEO**

TR500ME  
TRIM REMOVER



**TR500ME**



# E-COMMERCE PACKAGING SYSTEM

## SEALTAK™

The deferred seal system for cartons and boxes, Sealtak™ completely replaces the not so user-friendly transfer tape method.

- Increases the line speed, reducing the number of roll change stoppages compared to transfer tape
- Reduces material costs, avoiding the use of expensive transfer tape
- Produces a stronger bond by applying uniform adhesive pattern onto the substrate
- Easier peel and seal feature by leaving a section of silicone paper free from glue
- Silicone tape unwind can be integrated in machine or mounted remotely and can accept both pancake rolls and bobbin rolls

The SealTak system dispenses pressure sensitive hot melt adhesive to the substrate, then places a silicon release liner with offset over the glue to create peel and seal products.



## TEAR TAPE APPLICATOR

Tear tape unwinder can be mounted in the machine or remotely, outside of the machine.



## IN-LINE CROSS GLUING

Valco Melton offers a gluing system consisting of a bank of non-contact valves that apply glue dots. Easy to integrate into machine, this solution avoids the need to run the product again for the second gluing application or the need for a 90-degree turning attachment on your folder-gluer.



### WATCH VIDEO

SEALTAK™  
TECHNOLOGY



# VISION INSPECTION SYSTEMS

## HOW IT WORKS

Work with your glue system and ClearVision inspection cameras with one screen using BoxChek7 inspection software. BoxChek7 brings users complete information on production line performance in real time. The screen simultaneously displays live images, job statistics, defect images and historical defects to facilitate analysis.

## BENEFITS & GAINS

- Detect and identify defective gluing (hot melt or cold glue), folding, barcodes, print registration, corrugator scores, as well as issues with sheets such as skew
- Minimize configuration times on multi-point gluers with the system's ability to learn the position of the cameras and sensors
- Streamline support sessions using the online chat window
- Intuitive interface that displays real time images and data from each of the installed systems
- Defect and performance data for all boxes stored locally in SQL database and can be easily accessed remotely with MeasurementChek
- Systems can be viewed remotely through MySystemChek

## SOLUTIONS



**GLUECHEK**



**PRINTCHEK**



**SCORECHEK**



**GAPCHEK**



**FOLDCHEK**



**REGCHEK**



**BUNDLECHEK**



**CODECHEK**

# MAKING QUALITY VISIBLE



**GLUECHEK**

GlueChek takes a picture of every glue pattern. The system analyzes the glue pattern to ensure that no gluing problems exist. When a gluing problem is found, GlueChek shows the defect on the screen, notifies operators by alarm, then marks the defective box and saves an image of the gluing problem. By identifying and removing all defects before shipment, box makers can now provide 100% perfectly glued boxes to their customers. Having saved a picture of every defect builds operator confidence, helps maintenance troubleshoot, checks for skewed boards, and increases customer satisfaction.

Use top-down and bottom-up cameras together for automatic “backside detection” to ensure glue is on the desired face of the sheet and not present on the opposite side. GlueChek automatically recognizes backside detection function

Faulty boxes can be detected any at incredibly high speeds. As a result, our customers can boost production speed, saving valuable time and reducing delivery times.



**NARROW GLUECHEK**



**Double camera installation for back side inspection to detect glue residues**

The screenshot displays the GlueChek software interface. At the top, a summary bar shows production statistics: 20090447688, 323 (green checkmarks), 76 (red X marks), 5 (yellow question marks), and 0 (grey slash marks). The main interface is divided into several sections:

- Summary:** A sidebar menu with options like Summary, Order, CodeChk 1, GlueChk 2 (selected), FoldChk 3, BundleChk 4, RegChk 5, Defects, and Settings.
- GlueChk 2:** A live camera feed showing a glue pattern on a sheet of material. A green checkmark is visible in the bottom right corner of the feed.
- Registration:** A section showing registration data for Glue Start and Glue Stop, with values like 6.35, 12.7, and 8.35. It also includes checkboxes for Min Edge Clearance and Min Body Clearance.
- Coverage:** A section showing coverage data for Missing Line, Extra Line, Low Area, and High Area, with values like 79%, 79%, 40%, and 100%.



CodeChek eliminates customer quality problems caused by mixed copy. CodeChek system detects most types of binary and 2D barcode formats, including UPC, Code 128, QR Code and Data Matrix.

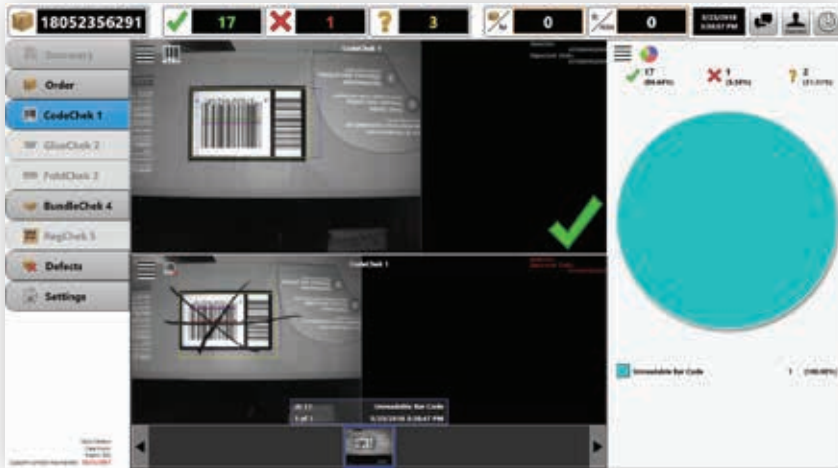

Capable of reading barcodes at high speeds up to 30 boxes/sec, and in areas up to 23 x 23 cm, it adapts to your production requirements with the ability to mount the camera bottom-up or top-down.



FoldChek takes a picture of every manufacturer's gap. It analyzes the gap for width and skew. When a problem is found, FoldChek clearly displays the defect on the screen showing what is wrong, sounds an alarm, marks the defective box, and saves an image of the defect.

Customers can now be assured that their boxes are free from folding problems and gap variation. Box makers can accurately specify gap requirements to meet customer needs and ensure only perfectly folded boxes arrive at the customer's door.



**FoldChek statistics displays the folding trends, allowing machine adjustments in order to obtain the proper desired gap width.**



# GAPCHEK

GapChek images the front and back of the entire straightened bundle and measures the lead and trail gaps directly at the box edge.

Each box is therefore measured as completed, statistics collected and marked for ejection of bundles with out-of-tolerance folds. GapChek is compatible with any conveyor type and mounted after the counter-ejector or bundle strapper to ensure easy mounting of cameras and lights.



### Errors detected

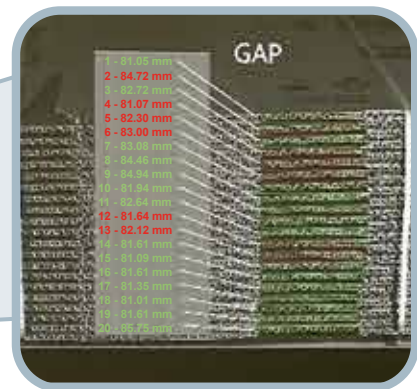
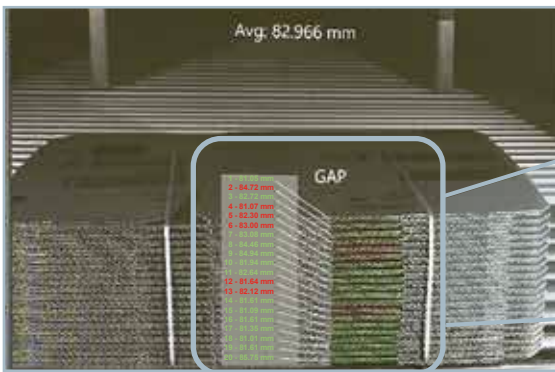

### Perfect bundle

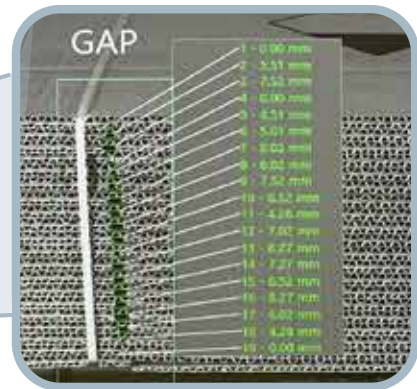
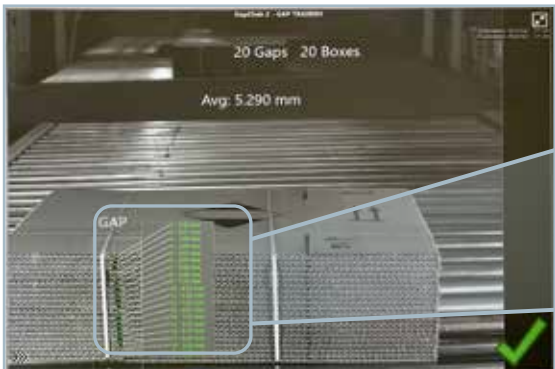

Every single gap and slot is measured. Errors are instantly detected.

**WATCH VIDEO**  
GAPCHEK  
INSPECTION  
SYSTEM







PrintChek is a full sheet inline print detection system used to inspect unwanted spots, registration (print-to-print and print-to-sheet), stripes, scratches, color, missing print, smearing, double-print/ghosting, drying, barcodes, blank measurement, board damage, delta-e color density, and skew.

Can be used on flexo folder-gluers and die-cut presses.

### Defect-free boxes



### Defect detected box

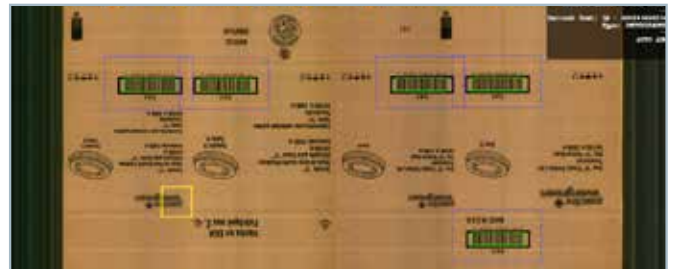
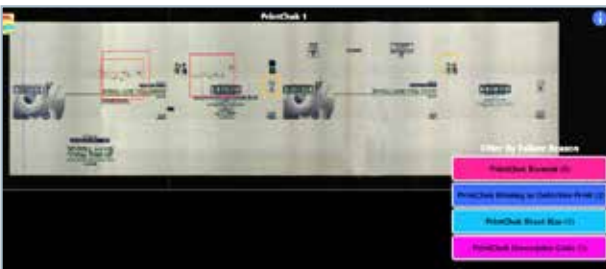

When any ClearVision camera identifies a defect, BundleChek receives a signal and marks the defective bundle. Then, when the bundle containing the defective box is identified by the BundleChek camera, it is immediately diverted to an alternate conveyor.

With BundleChek, manufacturers and customers alike can be sure that defective boxes are eliminated before the shipment makes it out your door.





Deliver perfectly manufactured boxes to your customers by inspecting and ensuring the integrity of corrugator scorelines on your sheets using ScoreChek. Using innovative ShadowChek camera technology, ScoreChek automatically images the sheet to highlight the scorelines for analysis. Scoreline position can then be accurately verified in order to determine the blanks are being fed correctly and the scores are within tolerances.

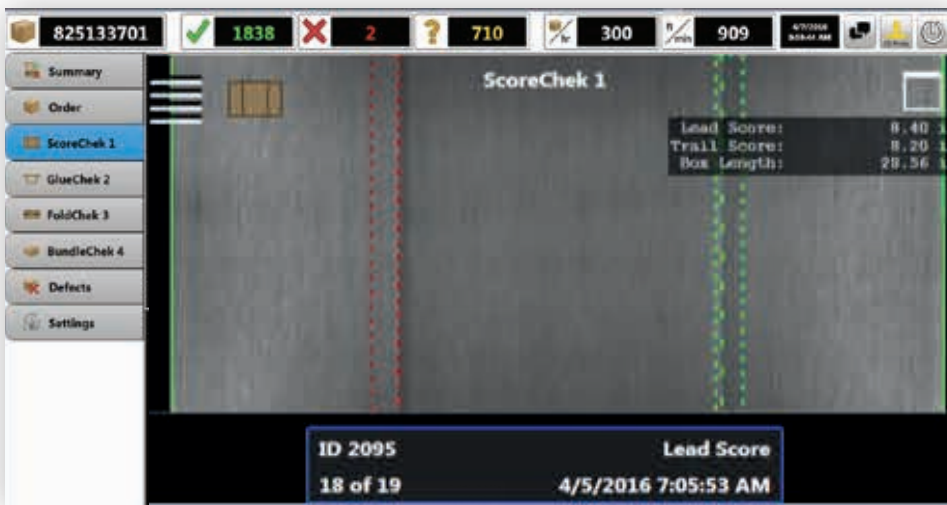

Using high speed imaging, RegChek captures images of each and every box to measure print variation in relation to the desired value set at the beginning of the order run. Where box design allows for it, RegChek also detects variations in the print registration in relation to the board edges, as well as variations in the slot depth.



Defect-free box



Defect detected

# GLOBAL SUPPORT

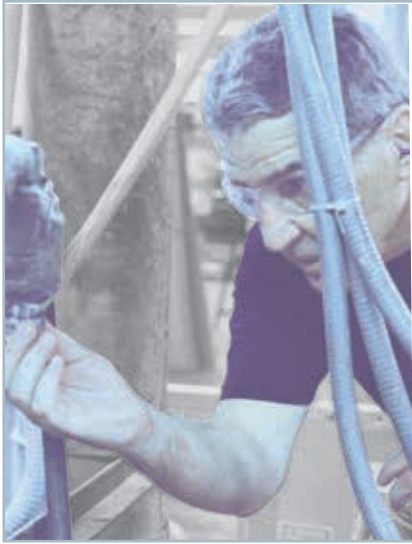

## PREVENTIVE MAINTENANCE

- ✓ Valco Melton's AssurancePlus is designed to keep your gluing systems performing at the highest quality, while minimizing machine downtime.
- ✓ Ensures the availability of a trained Valco Melton service technician for a recurring scheduled date and time.
- ✓ Preventative maintenance costs 3-5 times less than reactive maintenance costs.
- ✓ Scheduled semi-annual Valco Melton technician PM visits reduce the total cost of ownership by properly training personnel, replacing wearable parts and helping to identify potential problems before they become larger problems affecting productivity and quality.



## SUPPORTCHEK PLUS

- ✓ 24-hour remote support
- ✓ Monthly remote login and diagnostic check (with email report)
- ✓ Remote backup in case of system failure
- ✓ Access to MeasurementChek (tracks all boxes and orders run through machine)



**GET SUPPORT**

[WWW2.VALCOMELTON.COM/SUPPORT](http://WWW2.VALCOMELTON.COM/SUPPORT)

**Valco Melton is there when you need them with global network**

## World Headquarters

**USA, OH, Cincinnati** | Tel: +1.513.874.6550  
info@valcomelton.com

### America Manufacturing, Sales & Service Centers

**Canada, Vancouver, B.C.**  
**ClearVision Technologies**  
Tel: +1.604.998.4012  
canada@valcomelton.com

**USA West Coast, CA, Petaluma**  
**GMS-Vansco**  
Tel: +1.707.285.3392  
inquiry@gmsvansco.com

**Mexico, México D.F.**  
Tel: +52.55.6278.1727  
mexico@valcomelton.com

**Colombia, Bogotá**  
Tel: +57.313.421.0926  
colombia@valcomelton.com

**Brazil, Sao Paulo**  
Tel: +55.11.3071.2117  
brazil@valcomelton.com

### Europe Manufacturing, Sales & Service Centers

**Spain, Navarra, Orkoien** | Tel: +34 948 321 580  
spain@valcomelton.com

**France, Fleurieu-sur-Saône** | Tel: +33 (0) 4 75 78 13 73  
france@valcomelton.com

**Italy, Brescia** | Tel: +39 030 2732544  
italy@valcomelton.com

**Italy, Brescia | ERO s.l.r** | Tel: +39 030 2731503  
info@ero-gluers.com

**Benelux, The Netherlands** | Tel: +31 252-673673  
benelux@valcomelton.com

**Hungary, Budapest** | Tel: +36 1-214-4705  
hungary@valcomelton.com

**UK, England, Telford** | Tel: +44 1952-677911  
uk@valcomelton.com

**Germany, Düsseldorf** | Tel: +49.211 984 798-0  
germany@valcomelton.com

**Poland, Dlugoleka** | Tel: +48 71 889 04 50  
poland@valcomelton.com

**Czech Republic, Prague**  
czech@valcomelton.com



Direct Sales Centers ●  
Distributors Worldwide ●

### Asia & Middle East Manufacturing, Sales & Service Centers

**Turkey, Istanbul** | Tel: +90 212 327 99 71  
turkey@valcomelton.com

**India, Bangalore** | Tel: +91.80.46553300  
india@valcomelton.com

**UAE, Sharjah** | Tel: +971.521305960  
uae@valcomelton.com

**Saudi Arabia, Riyadh** | Tel: +966 544659139  
saudiarabia@valcomelton.com

### Asia Pacific Sales & Service Centers

**China, Shanghai** | china@valcomelton.com  
**China, Xiamen** | Tel: +86.592.591.7854

**Singapore, Singapore** | Tel: +65 850 95355  
singapore@valcomelton.com

**Philippines, Quezon City** | Tel: +63 917 535 0891  
philippines@valcomelton.com

**Indonesia, Jakarta** | Tel: +62 811 9112872  
indonesia@valcomelton.com

**Vietnam, Ho Chi Minh City** | Tel: +84 938 828 875  
vietnam@valcomelton.com

**Japan, Tokyo**  
japan@valcomelton.com

