

 **Saeco**

Xelsis 
SUPREMA
& DELUXE

Rispetto per il Caffè





Rispetto per il Caffè

Le respect du Café
Уважение к кофе



WWW.SAECO.COM/CARE

A

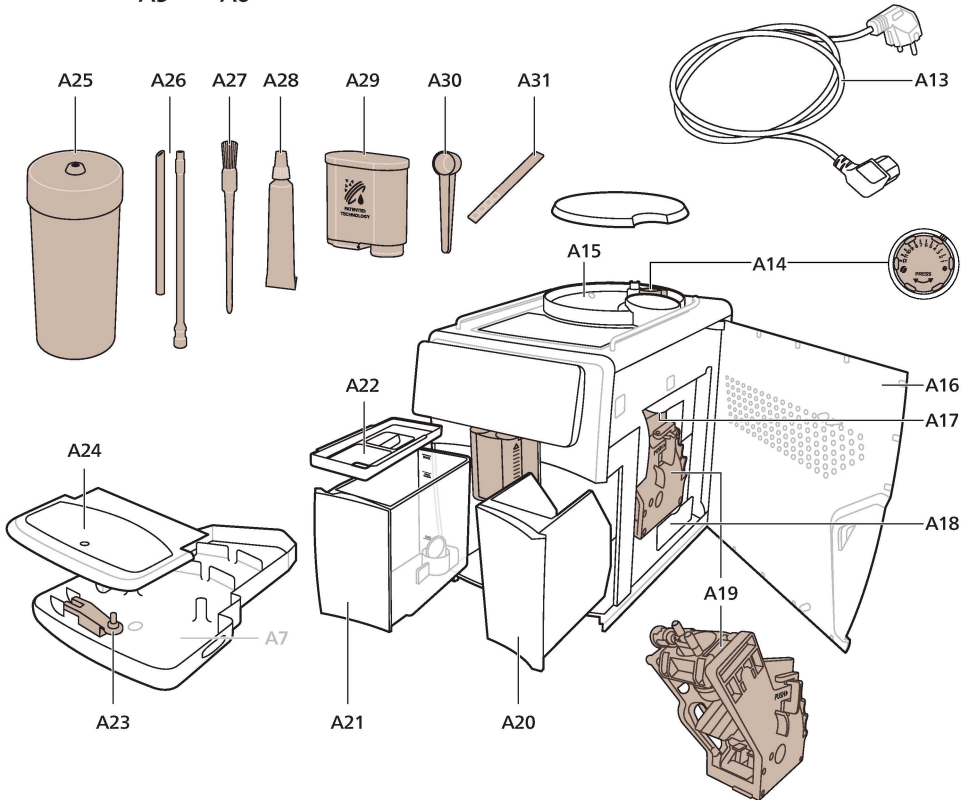
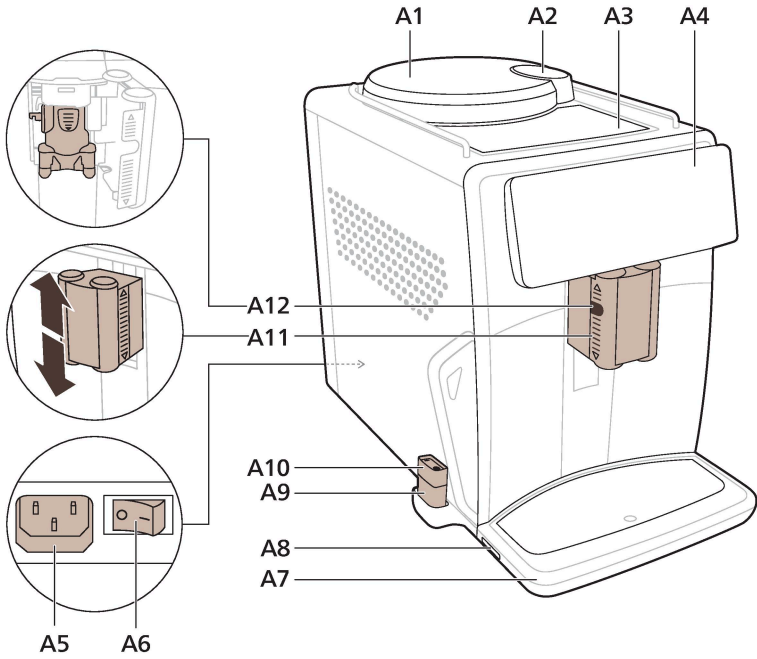

B Xelsis SUPREMA: SM8885, SM8889

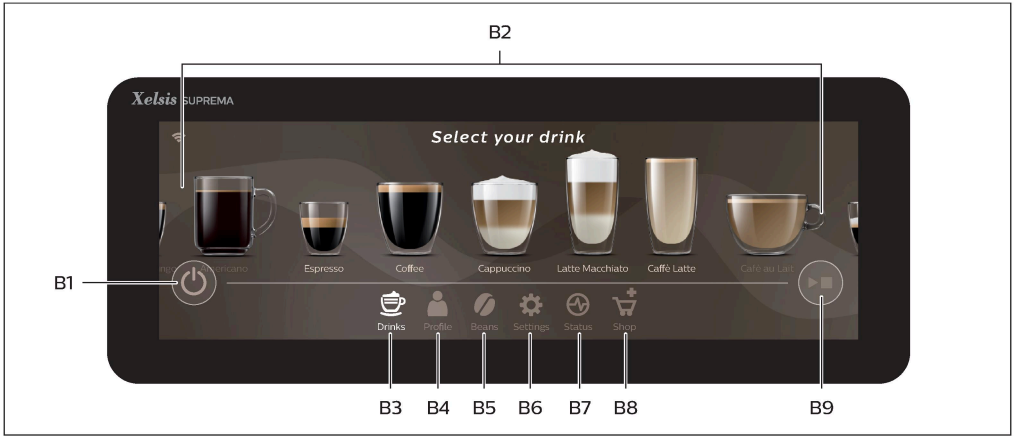

C Xelsis DELUXE: SM8780, SM8782, SM8785



D

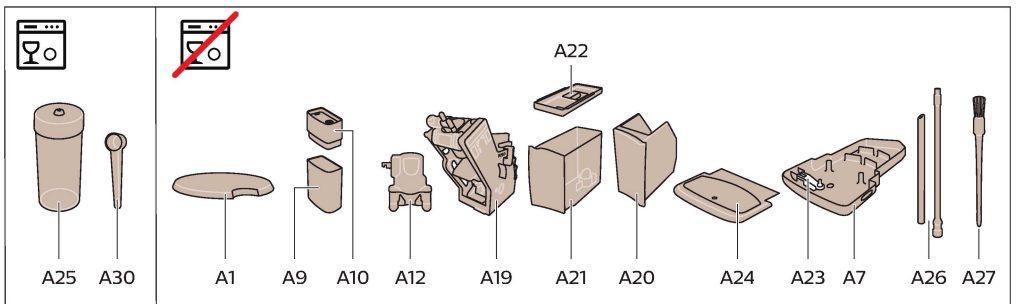

Machine overview (Fig. A)

A1 Lid of bean hopper	A13 Power cord with plug
A2 Lid of pre-ground coffee compartment	A14 Grind setting knob (to learn more, visit www.saeco.com/care)
A3 Cup tray	A15 Bean hopper
A4 Control panel	A16 Service door
A5 Socket for cord	A17 Coffee funnel
A6 Main switch	A18 Coffee residues drawer
A7 Drip tray	A19 Brew group (to learn more, visit www.saeco.com/care)
A8 Drip tray release grip	A20 Coffee grounds container
A9 HygieSteam container	A21 Water tank
A10 HygieSteam cover with milk tube holder	A22 Lid of water tank
A11 Height-adjustable coffee and milk dispensing spout	A23 'Drip tray full' indicator
A12 Internal cappuccinatore	A24 Drip tray cover

Accessories

A25 Milk container	A29 AquaClean filter
A26 Milk tube	A30 Measuring spoon
A27 Cleaning brush	A31 Water hardness test strip
A28 Grease tube	

Control panel

There are two versions of this espresso machine. Their control panels look different, but all icons work the same way. Refer to figures B and C for an overview of all icons. Below you can find the descriptions.

B1 Off icon	B5/C5 Beans
C1 On/off icon	B6/C6 Machine settings
B2/C2 Drinks	B7/C7 Status menu
B3/C3 Drinks menu	B8/C8 Shop
B4/C4 Personal profiles	B9/C9 Start/stop ► icon

Introduction

Congratulations on your purchase of a Saeco full-automatic coffee machine! To fully benefit from the online support that Saeco offers, you can use the control panel to register your machine via the built-in Wi-Fi connection, or go to www.saeco.com/MyCoffeeMachine and register your product there.

Read the separate safety booklet carefully before you use the machine for the first time and save it for future reference.

Your Saeco full-automatic coffee machine allows you to connect with your Wi-Fi network to enhance your coffee experience.

By connecting your machine to your Wi-Fi network, you will be able to:

- receive personalized recommendations based on machine learning
- enjoy regular software updates to enhance your user experience
- make use of the shop functionality, if available in your country
- you can link your machine to your Amazon account for accessory replenishment, if this option is available in your country
- connect to your Alexa home device to make use of voice control, if available in your country

Note: This machine has been tested with coffee. Although it has been carefully cleaned, there may be some coffee residues left. We guarantee, however, that the machine is absolutely new.

Switching on the machine when you have a Xelsis SUPREMA (SM8885, SM8889 only)

Switch on the machine by pressing the main switch on the back of the machine. Touch the center of the control panel to make the 'on' icon appear on the screen. Tap the 'on' icon and follow the step-by-step instructions on the control panel.



⚠ Please connect and update the machine at first installation and regularly check for manual updates.

Switching on the machine when you have a Xelsis DELUXE (SM8780, SM8782, SM8785 only)

Switch on the machine by pressing the main switch on the back of the machine. Tap the 'on' icon and follow the step-by-step instructions on the control panel.



⚠ Please connect and update the machine at first installation and regularly check for manual updates.

Connecting to Wi-Fi

i Connect your coffee machine to a 2.4 GHz 802.11 b/g/n home Wi-Fi network.

i Connecting your coffee machine to your home Wi-Fi network, provides you with an enhanced user experience.

i Make sure that the coffee machine and the Wi-Fi router are within range of each other.

Follow the steps below to connect your coffee machine to your Wi-Fi network.



- 1 Tap the Settings  icon and swipe from left to right to find the Wi-Fi icon.
- 2 Tap the Wi-Fi icon.
- 3 Follow the steps on the screen to connect your machine to your Wi-Fi network.

You are now ready to start your connected experience.

A The machine will perform the automatic rinsing cycle when it is switched on and off via voice control and when the machine has been inactive for a while and switches off. Please make sure that the environment of the machine is safe.

Special functions

Special function

Purpose

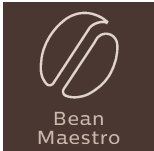

With BeanMaestro you are able to select the type and roast of your beans. It then optimizes the brewing settings automatically, to get the best out of your coffee beans.



HygieSteam function automatically cleans the milk system, removing microorganisms: use it after brewing cappuccino or other milk-based drinks.



Our durable grinder is made from 100% ceramic to be exceptionally hard and precise. It can be adjusted to your taste with 12-step levels.

Special function

Purpose



The Maintenance Dashboard gives you a helpful overview and notifies you with status information on things like your water level or tell you that the AquaClean is running low.

Brewing drinks

General steps

To brew a drink, you need to follow a few simple steps.



- 1 Fill the water tank with tap water and fill the bean hopper with beans.
- 2 Place one or two cups under the height-adjustable dispensing spout. Slide the dispensing spout up or down to adjust the height to the size of the cup or glass you are using.
- 3 Tap the Drinks  icon to enter the 'Drinks' menu. Swipe from left to right to select your drink by tapping on it.
 - Tap the '2x' icon if you want to brew two cups. The machine automatically carries out two grinding cycles in sequence of the selected drinks.

i The '2x' icon is not available for all drinks.

- 4 After selecting a drink, you can adjust the settings to your preference by swiping the adjustable bars up and down.
- 5 Press the start/stop  icon to start brewing the selected drink.

⚠ Do not use caramelized or flavored coffee beans.

i Turn the grind setting knob in small steps and after brewing 5 cups of coffee you start to taste the difference.

Support on drink parameters

To get additional information about a specific drink parameter, press and hold an adjustable bar for 3 seconds.



Brewing milk-based drinks

To brew milk-based drinks, you need to follow a few simple steps.

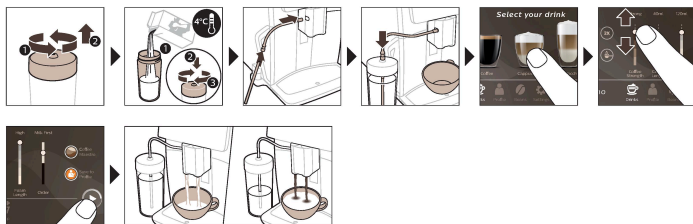

- 1 Fill the water tank with tap water and fill the bean hopper with beans.

Tip: When the flexible milk tube is connected to the cappuccinatore, slide the dispensing spout to the uppermost position for easy access to the water tank.

- 2 Unscrew the lid of the milk container and fill the milk container with milk.

Always use milk coming directly from the fridge for optimal results.

- 3 Connect the flexible milk tube to the cappuccinatore.
- 4 Place the metal milk tube in the container.
- 5 Tap the Drinks ☕ icon, scroll and select the milk-based drink icon of your choice.
- 6 You can adjust the settings to your preference by swiping the adjustable bars up and down.
- 7 Press the start/stop ►■ icon at any time to start brewing the selected drink.
 - For specific drinks, the machine first dispenses milk and then coffee. For a number of other drinks this is the other way around, the machine will first dispense coffee and then milk.
 - To stop dispensing milk before the machine has dispensed the preset amount, press the start/stop ►■ icon (SM8780, SM8782, SM8785 only) or press the stop icon (SM8885, SM8889 only).
 - To stop dispensing the complete drink (milk and coffee) before the machine is finished, press and hold the start/stop ►■ icon (SM8780, SM8782, SM8785 only) or press the stop icon (SM8885, SM8889 only).

A Directly after dispensing the milk, the 'HygieSteam Shot' is performed. The machine shoots steam through the internal milk system to rinse it quickly. The metal part of the milk tube may become hot. To avoid the risk of burns, let it cool down first.

Tip: You can also use a regular milk carton to brew your milk-based drinks. Place the metal milk tube directly into the milk carton.

Brewing coffee with pre-ground coffee

To brew coffee with pre-ground coffee, you need to follow a few simple steps.

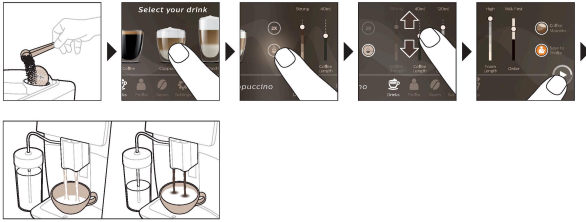

- 1 Open the lid of the pre-ground coffee compartment and pour one measuring spoon of pre-ground coffee into it. Then close the lid.
- 2 Tap the Drinks ☕ icon, scroll from left to right and select your drink.
- 3 Tap the pre-ground coffee ☕ icon.
- 4 You can adjust the settings to your preference by swiping the adjustable bars up and down.
- 5 Press the start/stop ▶■ icon to start brewing the selected drink.

i If you select pre-ground coffee, you cannot adjust the coffee strength or brew more than one drink at the same time.

Dispensing hot water

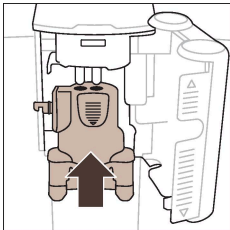

- 1 Make sure that the internal cappuccinatore is correctly attached to the machine.
- 2 Place a cup under the spout.



- 3 Tap 'Hot Water'.

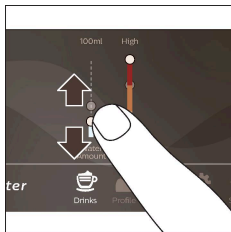

- 4 Slide the adjustable bars up and down to adjust the hot water quantity or temperature to your preference.
- 5 Press the start/stop ► icon.
- 6 To stop dispensing hot water before the machine is finished, press the start/ stop ► icon again (SM8780, SM8782, SM8785 only) or press the stop icon again (SM8885, SM8889 only).

Personalization

The machine allows you to adjust the settings of a drink to your own preference and to store the adjusted drink in a personal profile. You can choose your own icon and your own profile name.

Get the best out of your beans with the BeanMaestro function

With BeanMaestro you are able to select the type and roast of your beans. It then optimizes the brewing settings automatically, to get the best out of your coffee beans.

- 1 Tap on the Beans icon in the main menu.



- 2 Tap the BeanMaestro function.
- 3 Select the type of beans. You can choose between Arabica and Robusta blend.
- 4 Select the roasting level of your beans.
- 5 The brewing settings are optimized automatically.
- 6 Enjoy your next coffee.

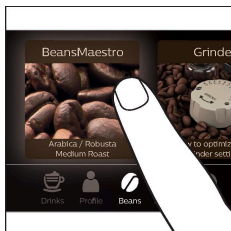

Speed up with CoffeeMaestro

Your machine offers the possibility to select taste profiles instead of adjusting all settings separately with the CoffeeMaestro function. You can choose between Delicato, Intenso and Forte. To select a CoffeeMaestro taste profile:



1 Tap the drink icon of your choice.

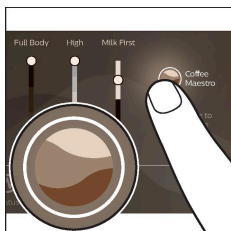

2 Tap the CoffeeMaestro icon repeatedly.

- The main settings of the drink are now adjusted accordingly.

3 Press the start/stop ► icon to start brewing the drink.

Personalize your drink with the CoffeeEqualizer Touch+ function

After selecting a drink, the CoffeeEqualizer Touch+ function is activated automatically, allowing you to adjust the drink settings. Long press on each of the items on the display to activate the help function and receive further information.

With the CoffeeEqualizer Touch+ function you can adjust the following settings:

- | | |
|----------------------------|---|
| 1 Aroma strength | 7 Coffee flavor |
| 2 Coffee quantity | 8 You can also decide to prepare 1 or 2 cups |
| 3 Milk quantity | 9 The order of first dispensing coffee or milk |
| 4 Water quantity | |
| 5 Drink temperature | |
| 6 Foam amount | |

Note: It depends on the drink you choose which settings you can adjust.

Save your favorite drinks in a profile

The machine allows you to adjust the settings of a drink to your own preference and to store the adjusted drink in a personal profile. You can select a profile and store a recipe using the profiles.

You can create a profile and add a drink using the profile 👤 icon.

1 Tap the profile 👤 icon on the main menu.

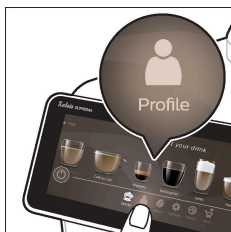

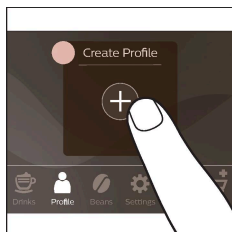

- 2 Tap the Plus icon.
- 3 Type your name and select your favorite icon.
- 4 You are ready to add a drink. Tap the drink icon of your choice.
- 5 Personalize the drink via the CoffeeEqualizer Touch⁺ or the CoffeeMaestro function.

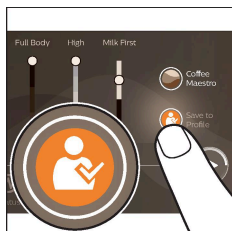

- 6 Tap on the 'Safe to profile' icon to store it in your personal profile.

Extra shot (ExtraShot)

Your machine offers you the possibility to add an extra shot of Ristretto to your coffee and milk drinks, for example if you want to have a stronger coffee.

- 1 Place a cup under the spout.
- 2 Tap one of the one-touch drinks icons to select a drink.



- 3 Slide the adjustable bar up to set the strength to the top level and select the ExtraShot function.
- 4 Then press the start/stop ► icon (SM8780, SM8782, SM8785 only) or press the start icon (SM8885, SM8889 only) to start brewing the drink.
- 5 To stop dispensing the drink before the machine has finished, press the start/stop ► icon again (SM8780, SM8782, SM8785 only) or press the stop icon again (SM8885, SM8889 only).

i When you have selected the ExtraShot function, you can only brew one coffee at a time.

i The extra shot function is not available for all drinks.

Adjusting machine settings

You can adjust most machine settings by tapping the Settings  icon and follow the steps on the screen.

For online support (frequently asked questions, movies etc.), scan the QR code on the cover of this booklet or visit www.saeco.com/care

Setting the water hardness

 We advise you to adjust the water hardness setting to the water hardness level in your region for optimal performance and a longer lifetime of the machine. This also prevents you from having to descale the machine too often. The default water hardness setting is 4: hard water.

Use the water hardness test strip supplied in the box to determine the water hardness in your region:

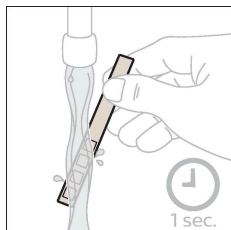

- 1 Immerse the water hardness test strip in tap water or hold it under the tap for 1 second.

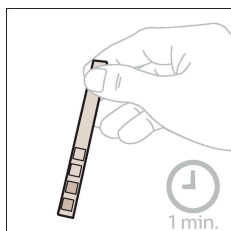

- 2 Wait 1 minute. The number of squares on the test strip that turn red indicate the water hardness.



Set the machine to the correct water hardness:

- 3 Tap the Settings  icon and scroll from left to right to select 'Water hardness'.
- 4 Select the water hardness level. The number of red squares selected on the display should be the same as the number of red squares on the test strip.
- 5 When you have set the correct water hardness, tap the confirmation  icon to confirm.

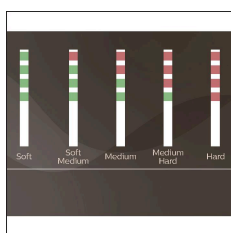

Adjusting the grind setting

You can change the coffee strength with the grind setting knob inside the bean container. The lower the grind setting, the finer the coffee beans are ground and the stronger the coffee becomes. There are 12 different grind settings you can choose from.

The machine has been set up to get the best taste out of your coffee beans. Therefore we advise you not to adjust the grind setting until you have brewed 100-150 cups (approx. 1 month of use).

 You need to brew 2 to 3 drinks before you can taste the full difference.



 Do not turn the grind setting knob more than one notch at a time to prevent damage to the grinder.

- 1 Tap the Beans icon in the main menu.

- 2 Tap on "Grinder".
- 3 Watch the how to video.

Restoring factory settings

The machine offers you the possibility to restore the factory settings at any moment.

- 1 Tap the Settings  icon.
- 2 Scroll from left to right to select 'Factory settings'. Confirm by tapping the confirmation  icon.
 - The settings are now restored.

i The following factory settings are restored to default: water hardness, standby time, display brightness, sound, front illumination, profiles, tank light, measure/units, home screen settings, BeanMaestro preferences, Wi-Fi credentials, software update preferences, Saeco credentials, Amazon credentials.

AquaClean water filter

Your machine is AquaClean enabled. You can place the AquaClean water filter in the water tank to preserve the taste of your coffee. It also diminishes the need for descaling by reducing limescale build-up in your machine. You can purchase an AquaClean water filter from your local or online retailer or from authorized service centers.

AquaClean filter status indication

The status of the AquaClean filter is always visible in the 'Status' menu as a percentage.

- If the status of the AquaClean filter is 10% or less, the screen shows a message for 2 seconds each time you switch on the machine. This message advises you to buy a new filter.
- If the status of the filter is 0%, the machine asks you to replace the AquaClean filter every time you switch on the machine.

Activating the AquaClean water filter (5 min.)

i The machine does not automatically detect that a filter has been placed in the water tank. Therefore you need to activate each new AquaClean water filter that you install in the 'Status' menu.

i When the machine stops showing the filter activation message, you can still activate an AquaClean water filter, but you will need to descale the machine first.

i Your machine has to be completely limescale-free before you start using the AquaClean water filter.

Before activating the AquaClean water filter, it has to be prepared by soaking it in water as described below. If you don't do this, air might be drawn into the

machine instead of water, which makes a lot of noise and prevents the machine from being able to brew coffee.

- 1 Tap the 'Status' icon and scroll from left to right to select 'AquaClean'.
- 2 Tap the confirmation ✓ icon again when the activation screen appears. Follow the instructions on the screen.

Replacing the AquaClean water filter (5 min.)

After 95 liters of water have flowed through the filter, the filter will cease to work. The AquaClean status indicator drops to 0% to remind you to replace the filter. If you do not replace the AquaClean water filter in time, you can still replace the filter but you first need to descale the machine.

When the AquaClean status indicator drops to 0% or when the machine reminds you to replace the AquaClean filter:

- 1 take out the old AquaClean water filter.
- 2 install a new filter and activate it as described in chapter 'Activating the AquaClean water filter (5 min.)'.

i Replace the AquaClean water filter at least every 3 months, even if the machine does not yet indicate that replacement is required.

Removing and inserting the brew group

Go to the 'Status' menu on the screen and select 'Brew group clean' or visit www.saeco.com/care for detailed video instructions on how to remove, insert and clean the brew group.

Removing the brew group from the machine

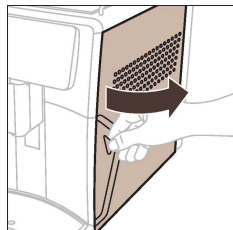

- 1 Open the service door.

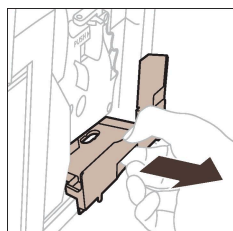

- 2 Remove the coffee residues drawer.

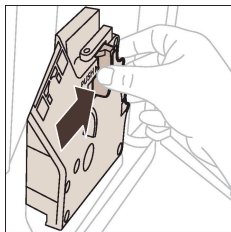

- 3** Press the PUSH button and pull at the grip of the brew group to remove it from the machine.

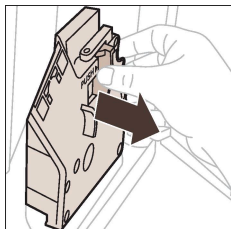

Reinserting the brew group

Before you slide the brew group back into the machine, make sure it is in the correct position.

- 1** Check if the arrow on the yellow cylinder on the side of the brew group is aligned with the black arrow and N.

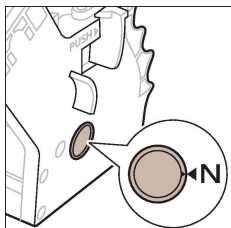

- If they are not aligned, push down the lever until it is in contact with the base of the brew group.

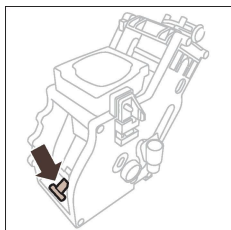

- 2** Make sure that the yellow locking hook on the other side of the brew group is in the correct position.

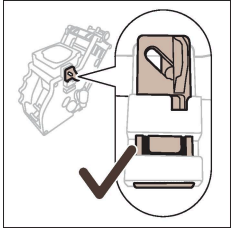

- To position the hook correctly, push it upwards until it is in uppermost position.

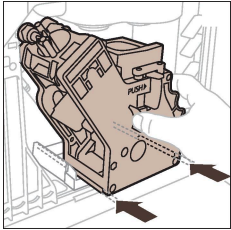

- 3 Slide the brew group back into the machine along the guiding rails on the sides until it locks into position with a click. Do not press the PUSH button.
- 4 Place back the coffee residues drawer and close the service door.

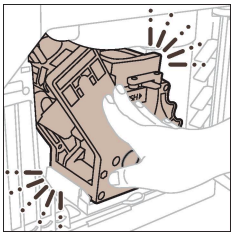



Cleaning and maintenance

Your machine will advise you when to perform cleaning and maintenance. Regular cleaning and maintenance keeps your machine in top condition and ensures good-tasting coffee for a long time with a steady coffee flow. Consult the table below for a detailed description of when and how to clean all detachable parts of the machine. You can find more detailed information and video instructions on www.saeco.com/care. See figure C for an overview of which parts can be cleaned in the dishwasher.

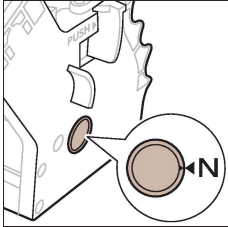
Item	When to clean	How to find in the control panel/ What to do
AquaClean filter	When the machine asks you or every three months.	STATUS->CLEANING->AQUACLEAN. Follow the steps to activate the AquaClean filter.

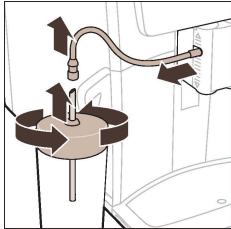
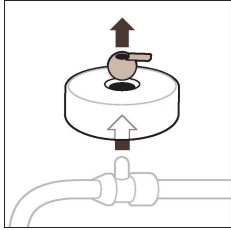
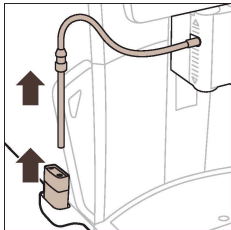
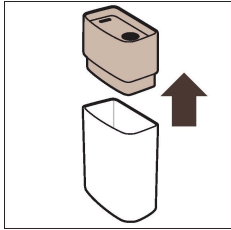
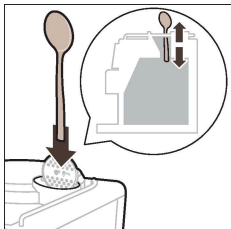
Item	When to clean	How to find in the control panel/ What to do
<p>i The machine does not automatically detect that a filter has been placed in the water tank. Therefore you need to activate each new AquaClean filter that you install in the 'Status' menu.</p>		
<p>i Your machine has to be completely limescale-free before you start using the AquaClean filter.</p>		
<p>i Replace the AquaClean filter at least every 3 months, even if the machine does not yet indicate that replacement is required.</p>		
Brew group	Weekly	STATUS -> PERFORMANCE -> BREW GROUP CLEAN. Follow the steps to remove and clean the brew group.
	<p>i Before you slide the brew group back into the machine, make sure it is in the correct position. The arrow on the yellow cylinder on the side of the brew group has to be aligned with the black arrow and N.</p>	
	Monthly	STATUS -> PERFORMANCE -> COFFEE OIL REMOVAL. Follow the steps of the self-cleaning process to automatically remove coffee oil residues from the brew group.
Milk system/internal cappuccinatore	After every day of use	STATUS -> HYGIESTEAM. Follow the steps of the self-cleaning process to clean the milk system. Wipe the outside of the metal milk tube with a damp cloth before placing it into the milk tube holder.
	Weekly	Remove and disassemble the internal cappuccinatore. Rinse all parts under the tap with some washing-up liquid.
	Monthly	STATUS -> HYGIESTEAM -> DEEP MILK CLEAN. Follow the steps of the self-cleaning process to clean the milk system.

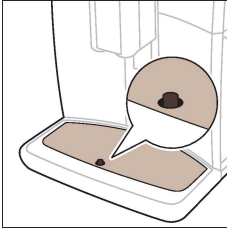
Item	When to clean	How to find in the control panel/ What to do
Milk container	Weekly	 <p data-bbox="852 181 1068 411">Disassemble the milk container and push out the ball using the pin of the milk tube. Clean all parts of the milk container under the tap or in the dishwasher.</p> 
HygieSteam container (milk tube holder)	Weekly or when the machine reminds you	 <p data-bbox="852 673 1068 903">Remove the HygieSteam container from the machine and remove the HygieSteam cover. Clean the HygieSteam container and cover under the tap.</p> 
Pre-ground coffee compartment	Check the pre-ground coffee compartment weekly to see if it is clogged	 <p data-bbox="852 1165 1068 1394">Unplug the machine and remove the brew group. Open the lid of the pre-ground coffee compartment and insert the spoon handle into it. Move the handle up and down until the clogged ground coffee falls down. Go to www.saeco.com/care for detailed video instructions.</p>

Item	When to clean	How to find in the control panel/ What to do
Coffee grounds container	Empty the coffee grounds container when prompted by the machine. Clean it weekly	Remove the coffee grounds container while the machine is switched on. Rinse it under the tap with some washing-up liquid.
Drip tray	 <p>Empty the drip tray daily or as soon as the red 'drip tray full' indicator pops up through the drip tray. Clean the drip tray weekly</p>	 <p>Remove the drip tray and rinse it under the tap with some washing-up liquid.</p>
Lubrication of the brew group	Every 2 months	Lubricate the brew group with the by-packed grease (see Lubricating the brew group). Go to www.saeco.com/care for detailed video instructions.
Water tank	Weekly	Rinse the water tank under the tap.
Machine front	Weekly	Clean with a non-abrasive cloth.
Descaling of the machine	When the machine asks you to descale	STATUS -> DESCALING. Follow the steps to descale the machine. When descaling is needed, the machine asks you to descale it, press the OK icon to start and follow the steps.

www.saeco.com/care

Cleaning the brew group

Regular cleaning of the brew group prevents coffee residues from clogging up the internal circuits. Go to the 'Status' menu on the screen and select 'Brew group clean' or visit www.saeco.com/care for support videos on how to remove, insert and clean the brew group.

Cleaning the brew group under the tap

- 1 Tap the 'Status' icon and scroll to select 'Brew group clean'.
- 2 Tap the confirmation ✓ icon to confirm and then follow the instructions on the screen.

Cleaning the brew group with the coffee oil remover tablets

Only use Philips coffee oil remover tablets.

- 1 Tap the 'Status' icon and scroll to select 'Brew group clean'.
- 2 Tap the confirmation ✓ icon to confirm and then follow the instructions on the screen.

Lubricating the brew group

To improve your machine's performance, we suggest that you lubricate the brew group every 2 months, to ensure that the moving parts continue to move smoothly.

- 1 Apply a thin layer of grease on the piston (grey part) of the brew group.

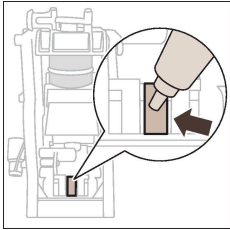

- 2 Apply a thin layer of grease around the shaft (grey part) in the bottom of the brew group.

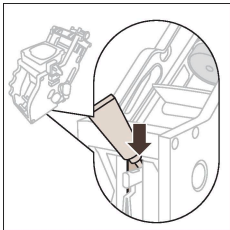

- 3 Apply a thin layer of grease to the guiding rails on both sides.

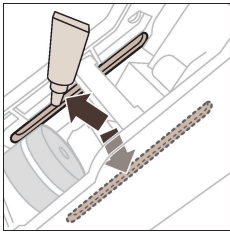

Cleaning programs for the internal cappuccinatore

i The machine tells you when to clean the internal cappuccinatore.

The machine has three programs to clean the internal cappuccinatore:

- 'HygieSteam Shot': during the preparation of a milk-based drink, the machine automatically shoots steam through the internal cappuccinatore to rinse it quickly.

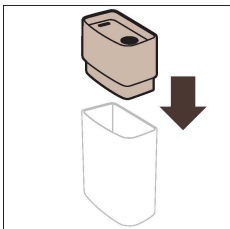

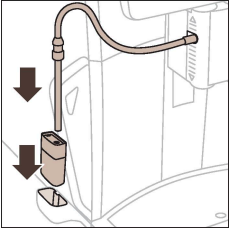

- 'HygieSteam': the machine thoroughly cleans the internal milk system with steam. Make sure that the HygieSteam container is correctly assembled and attached to the machine. Place the milk tube in the milk tube holder and follow the instructions on the screen.
- 'Deep Milk Clean': Perform the 'Deep Milk Clean' procedure with the Philips milk circuit cleaner for a thorough cleaning of the internal milk system.

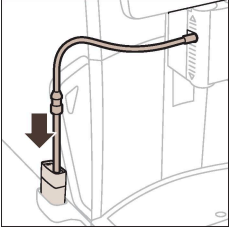

Cleaning the internal cappuccinatore under the tap

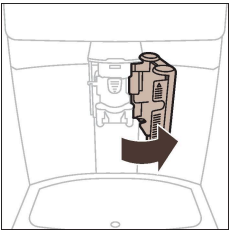

- 1 Open the door of the internal cappuccinatore.

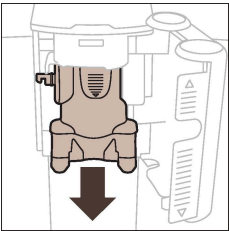

- 2 Remove the internal cappuccinatore by pulling it down.

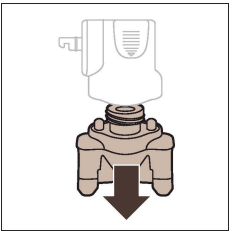

- 3 Disassemble the internal cappuccinatore by pulling the bottom part off the top part.

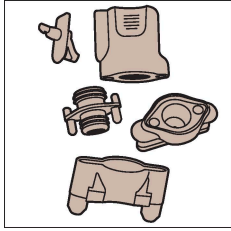

- 4 Disassemble all parts and clean them under the tap.
- 5 Reassemble the internal cappuccinator.

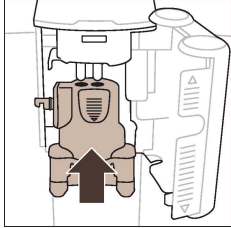

- 6 To place back the internal cappuccinator, put it in upright position and make sure the holes are aligned with the two tubes on the machine. Then move the internal cappuccinator upwards until it locks into place.
- 7 Close the door.

Visit www.saeco.com/care for detailed video instructions.

Descaling procedure

Please use Philips descaler only. Under no circumstances should you use a descaler based on sulfuric acid, hydrochloric acid, sulfamic or acetic acid (vinegar) as this may damage the water circuit in your machine and will not dissolve the limescale properly. Not using the Philips descaler will void your warranty. Failure to descale the appliance will also void your warranty. You can buy Philips descaler from your local or online retailer or from authorized service centers.

- 1 When the machine asks you to descale it, tap the confirmation ✓ icon to start. To start descaling without being prompted by the machine, tap the 'Status' icon and select 'Descale'.
- 2 Remove the drip tray, the coffee grounds container and the HygieSteam container, empty them and put them back into place.
- 3 Remove the water tank and empty it. Then remove the AquaClean filter.

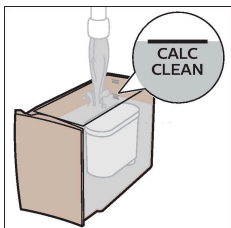
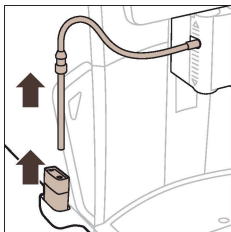

- 4 Pour the whole bottle of Philips descaler into the water tank and then fill it with water up to the CALC CLEAN level. Then place the water tank back into the machine.
- 5 Place a large container (1.5 l) under the coffee dispensing spout.

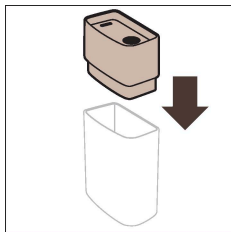

- 6 Make sure that the HygieSteam container is correctly assembled and attached to the machine. Place the milk tube in the milk tube holder.
- 7 Follow the instructions on the screen to start the descaling procedure. The descaling procedure lasts approx. 30 minutes and consists of a descaling cycle and a rinsing cycle.
- 8 Once the descaling cycle is finished, you need to rinse the water tank and water circuit. Follow the instructions on the screen.
- 9 Place a new AquaClean filter in the water tank and activate it (see [Activating the AquaClean water filter \(5 min.\)](#)).

Tip: Using the AquaClean filter reduces the need for descaling!

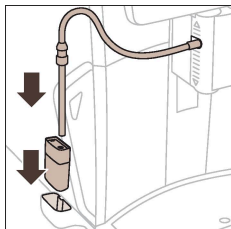

What to do if the descaling procedure is interrupted

You can exit the descaling procedure by pressing the on/off icon on the control panel. If the descaling procedure is interrupted before it is completely finished, some descaling liquid may remain in the water tank or the water circuit. In that case, do the following:

- 1 Empty and rinse the water tank thoroughly.
- 2 Fill the water tank with fresh water up to the CALC CLEAN level indication and switch the machine back on. The machine will heat up and perform an automatic rinsing cycle.
- 3 Before brewing any drinks, perform a manual rinsing cycle. To perform a manual rinsing cycle, first dispense half a water tank of hot water and then brew 2 cups of pre-ground coffee without adding ground coffee.

Note: If the descaling procedure was not completed, the machine will require another descaling procedure as soon as possible.

Error codes

Below you find a list of the error codes showing problems that you can solve yourself. Video instructions are available on www.saeco.com/care. If another error code appears, please contact the Consumer Care Center in your country. For contact details, see the warranty leaflet.

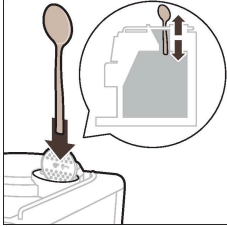
Error code	Problem	Possible solution
01	The coffee funnel is clogged.	 <p>Switch off the machine and unplug it. Remove the brew group. Then open the lid of the pre-ground coffee compartment and insert the spoon handle. Move the handle up and down until the clogged ground coffee falls down. Visit www.saeco.com/care for detailed video instructions.</p>
03	The brew group is dirty or not well-greased.	Switch off the machine. Rinse the brew group with fresh water, let it air-dry and then lubricate it (see Lubricating the brew group). Consult chapter 'Cleaning the brew group' or visit www.saeco.com/care for detailed video instructions. Then switch the machine on again.
04	The brew group is not positioned correctly.	Switch off the machine. Remove the brew group and reinsert it. Make sure that the brew group is in the correct position before you insert it. Consult chapter 'Handling the brew group' or visit www.saeco.com/care for detailed video instructions. Then switch the machine on again.
05	There is air in the water circuit.	Restart the machine by switching it off and on again. If this works, dispense 2-3 cups of hot water. Descale the machine if you have not done so for a longer period of time.
	The AquaClean filter was not prepared properly before installation or it is clogged.	Remove the AquaClean filter and try to brew a coffee again. If this works, make sure that the AquaClean filter is prepared properly before you place it back (see Activating the AquaClean water filter (5 min.)). Put the AquaClean filter back into the water tank. If this still does not work, the filter might be clogged and needs to be replaced.
11	The machine needs to adjust to room temperature	Allow some time for the machine to adjust from transport/ outdoor temperature to room temperature. Switch off the machine for 30 minutes and switch it on again. If this does not work, contact the Consumer Care Center in your country. For contact details, see the warranty leaflet.
14	The machine is overheated.	Switch off the machine and switch it back on after 30 minutes.
19	The machine is not connected to the wall socket properly.	Make sure that the small plug of the power cord is properly connected to the socket on the back of the machine.

Ordering accessories

To clean and descale the machine, only use Philips maintenance products. These products can be purchased by enabling Amazon Smart Reorders, from your local or online retailer or from authorized service centers.

i To be able to use Amazon Smart Reorders, you first need to activate this service on Amazon. Then follow the steps on the screen of your machine to connect your Amazon account to your Saeco account. After you have completed these steps, you can use the Amazon Smart Reorder service.

i In the 'Shop' menu on the control panel of the machine you can view the availability of Philips maintenance products and accessories at local retailers.

To find a full list of spare parts online, enter the type number of your machine. You can find the type number on the inside of the service door.

Maintenance products and type numbers:

- Descaling solution CA6700
- AquaClean filter CA6903
- Brew group grease HD5061
- Coffee oil remover tablets CA6704
- Milk circuit cleaner CA6705
- Maintenance kit CA6707

Software updates

Updating is essential to safeguard your privacy and proper functioning of your coffee machine. You can set whether you want to update your machine manually or whether you want it to be done automatically.

i When you have selected automatic updates, make sure that the machine is also plugged in at night and Wi-Fi is enabled, so that the machine can receive the software updates overnight.

i Updates are made available when there are software improvements, new features for the machine and to prevent a possible security issue.

i Mandatory firmware updates are started automatically when the coffee machine is in stand-by mode. During a firmware update the coffee machine cannot be used.

Troubleshooting

This chapter summarizes the most common problems you could encounter with the machine. Support videos and a complete list of frequently asked questions are available on www.saeco.com/care. If you are unable to solve the problem, contact the Consumer Care Center in your country. For contact details, see the warranty leaflet.

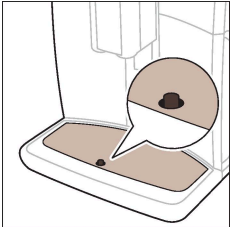
Problem	Cause	Solution
There are some coffee residues inside my new coffee machine.	This machine has been tested with coffee.	Although it has been carefully cleaned, there may be some coffee residues left. However, the machine is absolutely new.
The machine is in DEMO mode.	You pressed the standby icon for more than 8 seconds.	Switch the machine off and then on again with the main switch on the back of the machine.
The drip tray fills up quickly / there is always some water in the drip tray.	This is normal. The machine uses water to rinse the internal circuit and brew group. Some water flows through the internal system directly into the drip tray.	 <p data-bbox="897 360 1085 655">Empty the drip tray daily or as soon as the red 'drip tray full' indicator pops up through the drip tray cover. Tip: place a cup under the dispensing spout to collect rinsing water that comes out of it.</p>
The 'empty coffee grounds container' icon remains on.	You emptied the coffee grounds container while the machine was unplugged from the wall socket, or you placed it back too fast.	Remove the coffee grounds container, wait at least 5 seconds and then insert it again.
The machine prompts to empty the coffee grounds container even though the container is not full.	The machine did not reset the counter the last time you emptied the coffee grounds container.	Always wait approx. 5 seconds when you place back the coffee grounds container. In this way, the coffee pucks counter will be reset to zero and the number of coffee pucks is counted correctly.
The coffee grounds container is too full and the 'empty coffee grounds container' icon did not appear on the display.	You removed the drip tray without emptying the coffee grounds container.	When you remove the drip tray, also empty the coffee grounds container even if it contains only a few coffee pucks. This ensures that the coffee pucks counter is reset to zero and that the number of coffee pucks is counted correctly.
I cannot remove the brew group.	The brew group is not in the correct position.	Reset the machine in the following way: close the service door. Switch the machine off and back on again and wait until the machine is ready for use. Try to remove the brew group again (see Removing and inserting the brew group).

Problem**Cause****Solution**

I cannot insert the brew group.

The brew group is not in the correct position.

Reset the machine in the following way: close the service door. Leave the brew group out. Switch off the machine and unplug it. Wait for 30 seconds and then plug the machine back in, switch it on and wait until the machine is ready for use. Then put the brew group in the correct position and reinsert it into the machine (see [Removing and inserting the brew group](#)).

The coffee is watery.

The brew group is dirty or needs to be lubricated.

Remove the brew group, rinse it under the tap and leave it to dry. Then lubricate the moving parts (see [Lubricating the brew group](#)).

The machine is performing its self-adjustment procedure. This procedure is started automatically when you use the machine for the first time, when you change to another type of coffee beans or after a long period of non-use.

Brew 5 cups of coffee initially to allow the machine to complete its self-adjustment procedure.

The grinder is set to a too coarse setting.

Set the grinder to a finer (lower) setting. Brew 2 to 3 drinks to be able to taste the full difference.

The coffee is not hot enough.

The temperature is set too low.



Set the temperature to the maximum setting.

A cold cup reduces the temperature of the drink.

Preheat the cups by rinsing them with hot water.

Adding milk reduces the temperature of the drink.

Regardless of whether you add hot or cold milk, adding milk always reduces the temperature of the coffee. Preheat the cups by rinsing them with hot water.

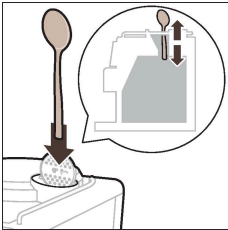
Problem	Cause	Solution
Coffee does not come out or coffee comes out slowly.	The AquaClean water filter was not prepared properly for installation.	Remove the AquaClean filter and dispense some hot water. If this works, the AquaClean filter was not installed properly. Reinstall and activate the AquaClean filter and follow all steps in chapter 'AquaClean water filter'. After a long period of non-use, you need to prepare the AquaClean water filter for use again and dispense 2-3 cups of hot water.
	The AquaClean water filter is clogged.	Replace the AquaClean water filter every 3 months. A filter that is older than 3 months can become clogged.
	The grinder is set to a too fine setting.	Set the grinder to a coarser (higher) setting. Note that this will impact the coffee taste.
	The brew group is dirty.	Remove the brew group and rinse it under the tap (see Cleaning the brew group under the tap).
	The coffee dispensing spout is dirty.	Clean the coffee dispensing spout and its holes with a pipe cleaner or needle.
	The pre-ground coffee compartment is clogged	 <p data-bbox="900 820 1072 1062">Switch off the machine and remove the brew group. Open the lid of the pre-ground coffee compartment and insert the spoon handle into it. Move the handle up and down until the clogged ground coffee falls down.</p>
	The machine circuit is blocked by limescale.	Descalc the machine with Philips descaler (see Descaling procedure). Always descale when the machine prompts you.
The milk does not froth.	The internal cappuccinatore is dirty or not inserted correctly.	Clean the internal cappuccinatore and make sure that you position and insert it correctly (see Cleaning the internal cappuccinatore under the tap).
	The type of milk used is not suitable for frothing.	Different types of milk result in different amounts of froth and different froth qualities.

Problem**Cause****Solution**

The milk is splashing.

The milk you use is not cold enough.

Make sure you use cold milk coming directly from the fridge.

The flexible milk tube is not connected properly.

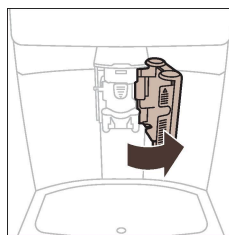

Open the door of the coffee dispensing spout and check if the flexible milk tube is fully connected to the cappuccinatore. Note that the cappuccinatore and milk tubes may be hot. Let the cappuccinatore and the tubes cool down before you touch them.

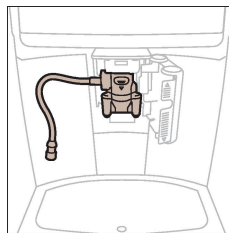

The cappuccinatore and milk tubes are not clean.

Remove and disassemble the internal cappuccinatore (see [Cleaning the internal cappuccinatore under the tap](#)). Rinse all parts under the tap. For thorough cleaning, use Philips milk circuit cleaner and perform the Deep Milk Clean procedure via the 'Status' and 'Hygiesteam' menu. Note that if the parts have been cleaned in the dishwasher, they may have become clogged by food particles or detergent residues. A visual check that they are not obstructed is also recommended.

We advise you to perform the HygieSteam program every day: 1) Press 'Status' on the control panel. 2) Select 'HygieSteam'. 3) Then confirm all steps on the display.

The milk tubes are clogged.

Always store the milk container without the milk tubes in the refrigerator. Leftover milk could accumulate inside the milk tubes and block the flow of milk through the tubes. Rinse the milk tubes before storage.

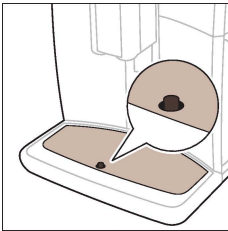
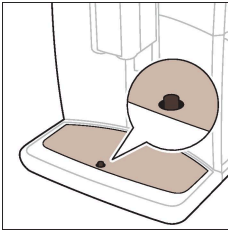
Problem	Cause	Solution
The machine seems to be leaking.	The machine uses water to rinse the internal circuit and brew group. This water flows through the internal system directly into the drip tray. This is normal.	 <p data-bbox="900 169 1070 472">Empty the drip tray every day or as soon as the 'drip tray full' indicator pops up through the drip tray cover. Tip: Place a cup under the dispensing spout to collect rinsing water and reduce the amount of water in the drip tray.</p>
	The drip tray is too full and has overflowed which makes it look like the machine is leaking.	 <p data-bbox="900 488 1070 719">Empty the drip tray every day or as soon as the 'drip tray full' indicator pops up through the drip tray cover.</p>
	The water tank is not fully inserted, some water is leaking out of the water tank and air is drawn into the machine.	Make sure the water tank is in the correct position: remove it and reinsert it into the machine as far as possible.
	The brew group is dirty/clogged.	Rinse the brew group.
	The machine is not placed on a horizontal surface.	Place the machine on a horizontal surface so that the drip tray does not overflow and the 'drip tray full' indicator works properly.
I cannot activate the AquaClean water filter and the machine asks for descaling.	The filter has not been installed or replaced in time after the screen showed the AquaClean reminder. This means your machine is not completely free of limescale anymore.	Descalcify your machine first and then install the AquaClean water filter.
The new water filter does not fit.	You are trying to install another filter than the AquaClean water filter.	Only the AquaClean water filter fits into the machine.
	The rubber ring on the AquaClean water filter is not in place.	Place back the rubber ring on the AquaClean water filter.

Problem	Cause	Solution
The machine is making a loud noise.	It is normal that your machine makes some noise during use.	If the machine starts to make a different kind of noise, clean the brew group and lubricate it (see Lubricating the brew group).
	The AquaClean water filter was not prepared properly and air is now drawn into the machine.	Remove the AquaClean water filter from the water tank and prepare it for use properly before you place it back (see AquaClean water filter).
	The water tank is not fully inserted and air is drawn into the machine.	Make sure the water tank is in the correct position: remove it and reinsert it by pushing it into the machine as far as possible.
When I try to connect the machine to Wi-Fi for the first time, the machine cannot connect to the Wi-Fi network.	Your Wi-Fi name and password are not correct.	Check your Wi-Fi name and password.
	The coffee machine and the Wi-Fi router are not within range of each other.	Ensure that the coffee machine and the Wi-Fi router are within range of each other. or use a Wi-Fi repeater.
The machine is not able to find the home Wi-Fi network.	The Wi-Fi router is not working properly.	Please make sure that the Wi-Fi router is working properly and is connected to the internet.
	The machine is not within range of the router.	Make sure the machine is within range of the router. You can also use a Wi-Fi signal repeater.
	The router your coffee machine is trying to connect to is 5 GHz dual-band and your coffee machine is not trying to connect to a 2.4 GHz network.	5 GHz networks are not supported. Temporarily switch off the 5 GHz band in your router and try to pair your coffee machine again to another band of the same router (2.4 GHz). Switch on your 5 GHz band again after successful pairing
I cannot use Alexa and Amazon Smart Reorders yet.	You have not yet connected to your Amazon to your Saeco account.	Please follow the instructions on the control panel of the machine to connect your Amazon account to your Saeco account to be able to use Alexa voice control and Amazon Smart Reorders.
		<p>Note: To be able to use these features you need to have an Alexa app or an Alexa device and you need to enable the Smart Reorders service on Amazon.</p>

Problem	Cause	Solution
The Wi-Fi connectivity of the machine used to work but is not working anymore.	Your Wi-Fi name and/or password has changed.	Follow the instructions of section 'Connecting to Wi-Fi' and choose the network with the new Wi-Fi name to connect to.
	The Wi-Fi password has changed.	Follow the instructions of section 'Connecting to Wi-Fi' and enter the new Wi-Fi password.
	Your Wi-Fi router is not working properly.	Check the router and make sure it is working.
	The Wi-Fi connectivity can be interrupted by electromagnetic or other interferences.	Keep the appliance away from other electronic devices that may cause interferences.
	None of the solutions mentioned above work.	Switch the machine off and then on again with the main switch on the back to recheck the Wi-Fi connection.

Technical specifications

The manufacturer reserves the right to improve the technical specifications of the product. All the preset quantities are approximate.

Description	Value
Size (w x h x d)	287 x 396 x 487 mm
Weight	11 - 12.4 kg
Power cord length	1200 mm
Water tank	1.7 liters, removable
Bean hopper capacity	450 g
Coffee grounds container capacity	15 pucks
Milk container capacity	600 ml
Height-adjustable spout height	75-148 mm
Nominal voltage - Power rating - Power supply	See data plate on the inside of service door
Wi-Fi frequency band	2.4 GHz 802.11 b/g/n

Declaration of Conformity

Hereby, DAP B.V. declares that the fully automatic espresso machines SM8780, SM8782, SM8785, SM8885 and SM8889 are in compliance with Directive 2014/53/EU.

The full text of the EU declaration of conformity is available at the following internet address: <https://www.saeco.com>.

The fully automatic espresso machines SM8780, SM8782, SM8785, SM8885 and SM8889 are equipped with a Wi-Fi module, 2.4 GHz 802.11 b/g/n (channels 1..13). Maximum transmitting power <100 mW(20 dBm).

Wi-Fi

The machine is a networked equipment, in compliance with reg. (EU) No 801/2013, and it is intended to be used permanently connected to a 2.4 GHz 802.11 b/g/n network.

4219.450.3076.2 (01/2022) rev.00



421945030762

www.saeco.com/care

EAC



>75% recycled paper
>75% papier recyclé