

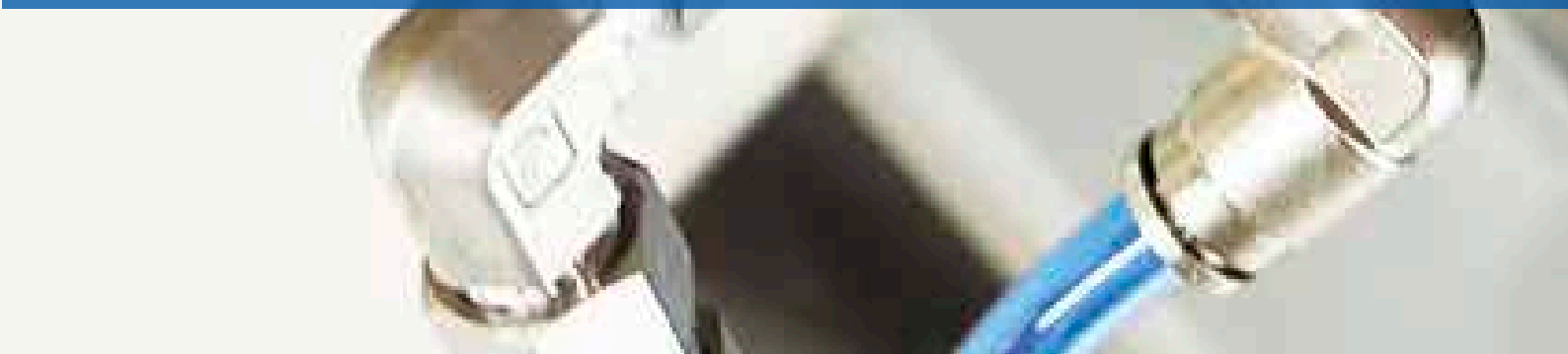

SOLUTIONS PROVIDER OF GLUING SYSTEMS TO THE

TISSUE INDUSTRY



WHO WE ARE

Valco Melton is a world-leading manufacturer of hot melt and cold glue adhesive dispensing equipment and quality inspection systems across 12 markets including the packaging, paper converting, graphic art, nonwoven, and tissue industries.

Combined with our commitment to providing unparalleled customer service, we offer one of the largest support networks with a team of knowledgeable sales and service personnel working to provide personal assistance in over 96 countries worldwide.

Valco Melton offers a variety of adhesive application systems for tissue converting and tissue machines. Valco Melton's solutions include transfer and pick-up, tail sealing, core winding, full sheet turn-up systems, perfume dispensing, and box sealing.

APPLICATIONS

1. Corewinding

2. Adhesive Pickup System

3. Tail Tie System

4. Full Sheet Turn-Up

5. Perfume Application

6. Case & Carton Packaging

7. Palletizing

COREWINDING

Corewinding system manufactures single or multi-ply spiral wound core-stock into cores during the tissue or towel converting process. The Corewinding System from Valco Melton can bring instant return on investment to nearly any adhesive application of up to 30% for 2-ply and 80% for single-ply cores.

Available for single and multi-ply cores, Corewinding work for spiral-wound cores of all sizes. Each system features a valve applicator, valve lift and bracket, automatic flow control, and an adjustable stand. It includes a mechanical web guide with integrated paper tension device. Optional oiler system is available to keep the mandrel cool and warming hose system that ensures consistent adhesive viscosity regardless of ambient temperature conditions.

Corewinding system is completely enclosed, eliminating contamination and minimizing clean-up. It replaces outdated messy pot & wheel systems minimizing maintenance and drastically reducing glue waste.

BENEFITS

No glue slinging

Glue consumption reduction

Enclosed system, no contamination

Reduced maintenance & clean-up

Higher quality end product

Simple and fast installation



Corewinding enclosed system prevents adhesive waste and product damage

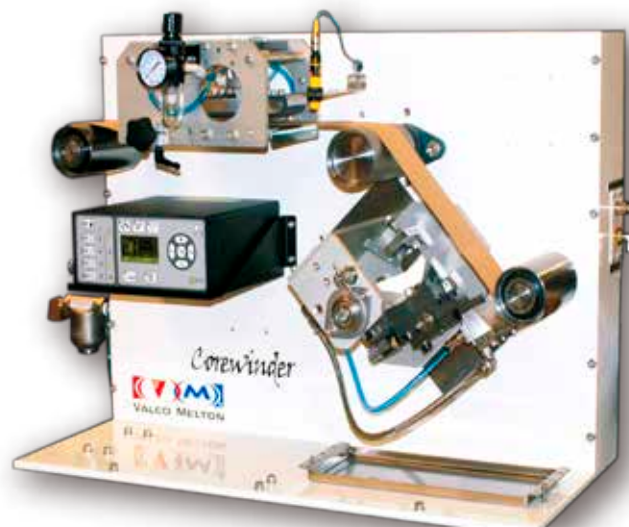

Corewinding stand

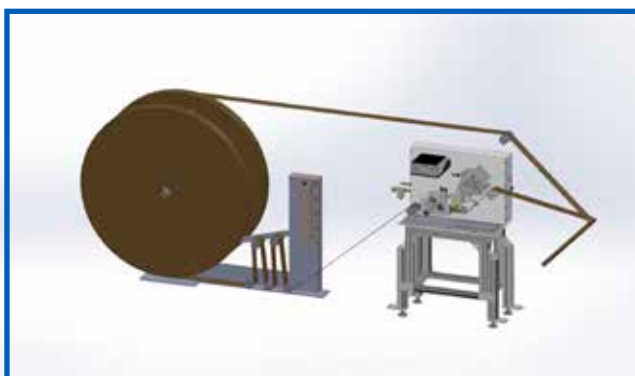

Complete system layout



Multi-ply configuration

ADHESIVE PICKUP SYSTEM

Valco Melton's programmable extrusion systems for applying pickup adhesives on tissue machines offer increased uptime and eliminate quality issues often experienced with open systems. The enclosed application system from Valco Melton eliminates adhesive contamination while applying consistent glue patterns at all speeds.

Valco Melton has a complete line of solutions for pick-up applications. Easily change the amount of adhesive applied to improve efficiency without over-saturating the product.



Valco Melton's enclosed and pressurized system applies consistent patterns at all speeds



Applicators can be easily removed for cleaning or changing



BENEFITS

- Precise glue application control**
- Reduce adhesive use**
- Minimize cleanup and maintenance**
- Consistent glue viscosity**
- Reduce adhesive slinging**

The amount and pressure of adhesive applied can be easily adjusted.



TAIL TIE SYSTEM

Consistent application of tail tie adhesives to create an appropriate bond without bleed through is often a quality issue when finishing tissue and towel rolls. Valco Melton offers bead and spray applicators specifically designed to eliminate these concerns. Stitch patterns offer significant adhesive savings while spray application aerates the adhesive reducing potential soak through multiple layers.



Valco Melton's valves are high speed and avoid glue waste when shut off. Valves feature a ceramic plunger and seat with no dynamic seals for long life. Precision volume of glue application adjustment prevents soak through to multiple layers.



FEATURES

- Controlled, high-speed bead application can apply lines or droplets without dripping.
- Narrow fan pattern application creates a strong bond without overspray or bleed through.
- Precise control over the amount and placement of adhesive while minimizing material handling and constant adjustment.

FULL SHEET TURN-UP

TISSUE TACK & REEL SYSTEM

Tissue machine speeds have continued to increase over recent years and a fast and efficient tail full sheet turn-up system is a major contributor to reducing total cost per ton. Valco Melton's patented Tissue Tack and Reel System for full sheet turn-up on tissue machines increases tissue mill productivity and increases machine output by at least 3% per year. Return on investment for the Valco Melton Tissue Tack and Reel system can be achieved in as little as three months.

The automatic reel turn up removes the need for operator intervention and increases safety around the area.

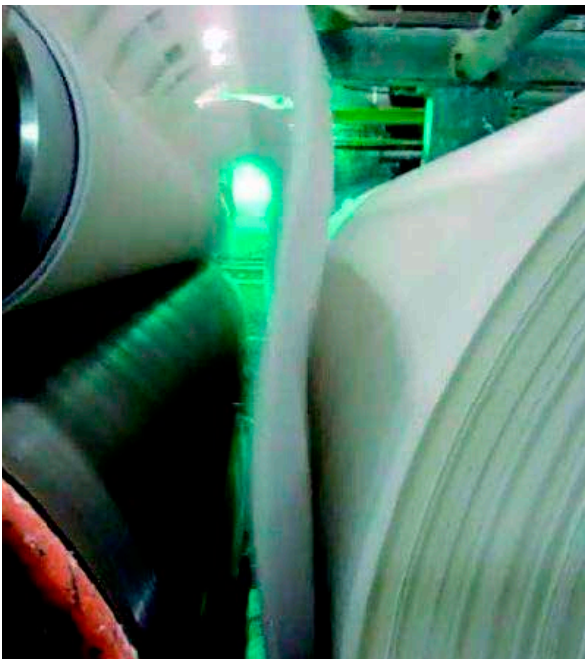

***Increase machine efficiency
by at least 3% each year & get
ROI in as little as 3 months.***

BENEFITS

- High turn-up efficiency**
- No tissue pulp recirculation**
- Water and dust resistant**
- Eliminate human errors**
- Available for any machine width**
- Eliminate safety concerns in the reel section**

Customized for any machine width, the Tissue Tack and Reel System consists of two major components. The rotating manifold and spray head assembly is mounted over the web for full width turn-ups and a single-valve tail tie is used during a sheet break. The second component is VM's TTR50 PLC controlled adhesive supply unit, located on the drive side of the tissue machine. Plug-and-play electrical components allow for a quick installation during a short machine shutdown.



PERFUME APPLICATION

Perfume has traditionally been used on tissue rolls to mask the odor of adhesives and raw materials. These sprayed liquids release particles in the air, causing unnecessary perfume waste and creating a potential health hazard. Operators might suffer from itchy eyes, dizziness and further hazards caused by the irritating substances atomized.

Valco Melton has engineered a perfume solution that applies precise perfume dots on each and every product, keeping the air free from atomized substances. Perfume drop application brings up to 60% in perfume savings, with ROI's as low as 3 months.

***Perfume drop application
creates savings and a safer
environment***

BENEFITS

- Replace spray with perfume dots**
- No more perfume lost in the air**
- ROI in less than 3 months**
- Increase safety**
- Safer working environment**
- Reduced maintenance**

Valco Melton's perfume solution is a cost-efficient and eco-friendly dispensing technology that ensures a safer working environment for machine operators in comparison to spray or atomizing perfume systems

Traditional systems feature metallic parts inside the dispensing system and valves, resulting in higher maintenance and operational costs. Valco Melton's valve's key components are made of ceramic & stainless steel and there are not dynamic seals. They are long-lasting and require less maintenance.



Perfume application valve and cabinet

CASE & CARTON PACKAGING

Valco Melton's hot melt gluing solutions for all types of case & carton sealing applications.

Valco Melton offers traditional pneumatic hot melt solutions, EcoStitch all-electric hot melt solutions, and Melt On Demand hot melt solutions for all of your case sealing closure needs.



Tissue Carton Sealing



Case Erecting/Sealing



PNEUMATIC HOT MELT SOLUTIONS

Our pneumatic hot melt system solutions are engineered and designed to meet the quality, consistency and economics of traditional packaging applications for nearly any application.



New Kube Melter

Energy-efficient hot melt melter with automatic feeding system



MKF series

Insulated compact applicator



ME series

Double Effect (AO/AC) applicator



MS series

Modular gun for standard application

ECOSTITCH ALL-ELECTRIC TECHNOLOGY

Valco Melton is best known for EcoStitch All Electric Hot Melt gluing solutions. The EcoStitch solutions feature the ability to immediately reduce adhesive consumption by up to 75% while maintaining a quality bonded product. The reduction in adhesive usage guarantees payback starting at 4 months.

Because of its unique design that eliminates the use of compressed air, EcoStitch solutions have zero dynamic seals and no wear items or replacement parts needed.

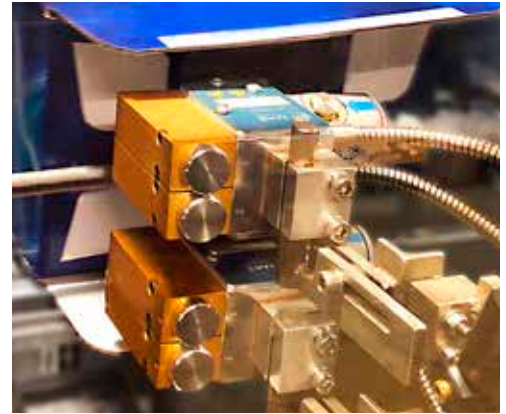

EcoStitch All-Electric technology reduce adhesive usage buy up to 75%

ECOSTITCH BENEFITS

- Adhesive usage reduction by 40-70%**
- Return on investment starting at 4 months**
- Eliminates compressed air**
- Reduced maintenance**
- Minimized downtime**

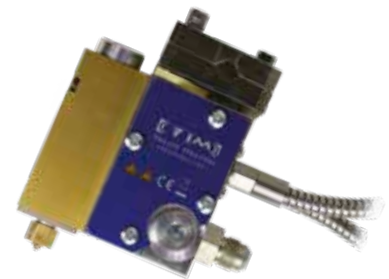

MXM EcoStitch All-Electric gun



EcoStitch hot melt units are available in 4L, 10L, and 16L capacities

MELT ON DEMAND HOT MELT SOLUTIONS

Valco Melton's Kube system features Melt On Demand technology. The Kube is a "first in, first out" melter that is automatically fed with a fully integrated Auto Feed System that keeps the adhesive fresh and eliminates the build-up of char and adhesive degradation as sometimes seen in traditional melters.

Melt On Demand hot melt system solution is engineered and designed to meet the quality, consistency and economics of traditional packaging applications.



Kube Melt on Demand System

PALLETIZING

Valco Melton's adhesive-based palletizing systems is an efficient and cost-effective alternative to traditional plastic wrapping.

By applying the precise amount of adhesive required on carton boxes, products are safely stacked for transportation and delivery to customers. This palletizing systems increase overall line efficiency by avoiding unnecessary costs related to stretch film wrap such as material, disposal, and intensive labor.

BENEFITS

- Complete pallet stabilization**
- Reduced film and plastic usage**
- Material and work savings**
- Sustainable alternative**
- Simple installation**

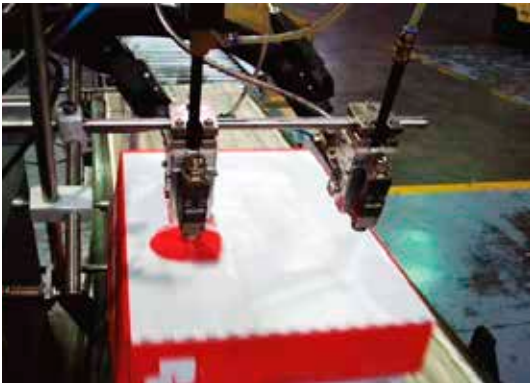

The use of anti-slip hot melt adhesive replaces, completely or partially, the use of stretch wrap. This reduces consumable costs up to 80%, and takes a step towards a more sustainable supply chain, with the reduction or elimination of polluting waste (stretch wrap or thermo-shrink film).

To avoid any damage on corrugated boxes, sacks, or shrinkable film, Valco Melton's systems use low tack adhesives, which allow products to be restacked several times while keeping their adhesion capabilities. No need to discard amounts of stretch wrap for restacking processes.

***Valco Melton's palletizing solution
minimizes product damage while
avoiding unnecessary material costs***

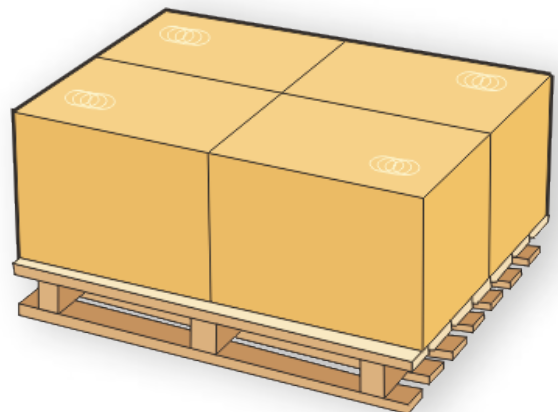

*The application of adhesive in spray or beads
allows companies to get rid of wrapping plastic*

ADHESIVE PUMPS

Valco Melton offers a variety of pump styles including low pressure diaphragm pumps and high pressure piston pumps.

GOING FOR A LOW-PRESSURE PUMP

DD-1 Low Pressure Pump



Diaphragm pumps are our recommended solution for a lot of applications and are an excellent alternative to piston pumps offering numerous benefits. Low-pressure pumps work with all kinds of adhesives with minimal wear and require less maintenance resulting in a more cost-effective option. DD-1 electronically controlled diaphragm pump offers extreme reliability and doesn't hang up or stall. When used for intermittent output applications, the pump will stop, then immediately restart as the system requires.

Valco Melton's DD-1 diaphragm pump features a unique electronic-reversing mechanism which allows the pump shaft to creep slowly and avoids stroke stalling.

HIGH-PRESSURE PUMPS OPTIONS



EPP-9 Piston Pump

EPP-9 features an electronically controlled reversing device for fast, reliable pulse-free operation. Air-powered, the EPP-9 piston pump offers an output ratio of 9:1, with a minimum air pressure of 20 psi and a maximum air pressure of 100 psi.

PFRM-5 Pump System

The PFRM-5 is an all-in-one pump combination system consisting of a 7:1 pump, filter, 5:1 pressure-balancing regulator, and a four-port manifold.



World Headquarters

USA, OH, Cincinnati | Tel: +1.513.874.6550
info@valcomelton.com

America Manufacturing, Sales & Service Centers

Canada, Vancouver, B.C.
ClearVision Technologies
Tel: +1.604.998.4012
canada@valcomelton.com

USA West Coast, CA, Petaluma
GMS-Vansco
Tel: +1.707.285.3392
inquiry@gmsvansco.com

Mexico, México D.F.
Tel: +52.55.6278.1727
mexico@valcomelton.com

Colombia, Bogotá
Tel: +57.313.421.0926
colombia@valcomelton.com

Brazil, Sao Paulo
Tel: +55.11.3071.2117
brazil@valcomelton.com

Europe Manufacturing, Sales & Service Centers

Spain, Navarra, Orkoien | Tel: +34 948 321 580
spain@valcomelton.com

France, Valence | Tel: +33 (0) 4 75 78 13 73
france@valcomelton.com

Italy, Brescia | Tel: +39 030 2732544
italy@valcomelton.com

Italy, Brescia | **ERO s.l.r** | Tel: +39 030 2731503
info@ero-gluers.com

Benelux, The Netherlands | Tel: +31 252-673673
benelux@valcomelton.com

Hungary, Budapest | Tel: +36 1-214-4705
hungary@valcomelton.com

UK, England, Telford | Tel: +44 1952-677911
uk@valcomelton.com

Germany, Düsseldorf | Tel: +49.211 984 798-0
germany@valcomelton.com

Poland, Dlugoleka | Tel: +48 71 889 04 50
poland@valcomelton.com

Czech Republic, Prague
czech@valcomelton.com



South, Southeast, West & Central Asia Manufacturing, Sales & Service Centers

Turkey, Istanbul | Tel: +90 212 327 99 71
turkey@valcomelton.com

India, Bangalore | Tel: +91.80.46553300
india@valcomelton.com

UAE, Sharjah | Tel: +971.521305960
uae@valcomelton.com

Singapore, Singapore | Tel: +65 850 95355
singapore@valcomelton.com

East Asia Sales & Service Centers

China, Shanghai | china@valcomelton.com
China, Xiamen | Tel: +86.592.591.7854
Fax: +86.592.591.7834 | china@valcomelton.com

To find the office nearest you, visit:
<http://bit.ly/2Cb8Fv2>
or snap a picture of this QR Code

