

**VELUX®**

---

**FMG**



VAS 452105-2013-02

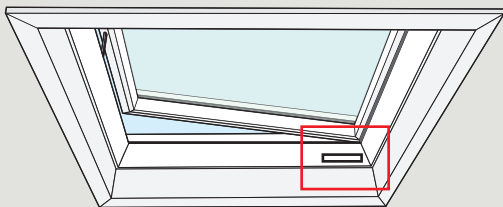

**CVP**



**pages  
4-19**

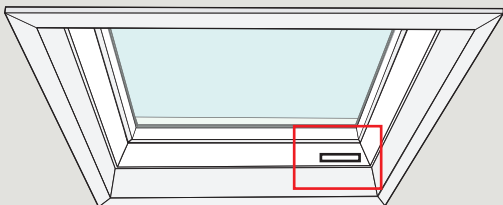

**CFP**



**pages  
20-31**

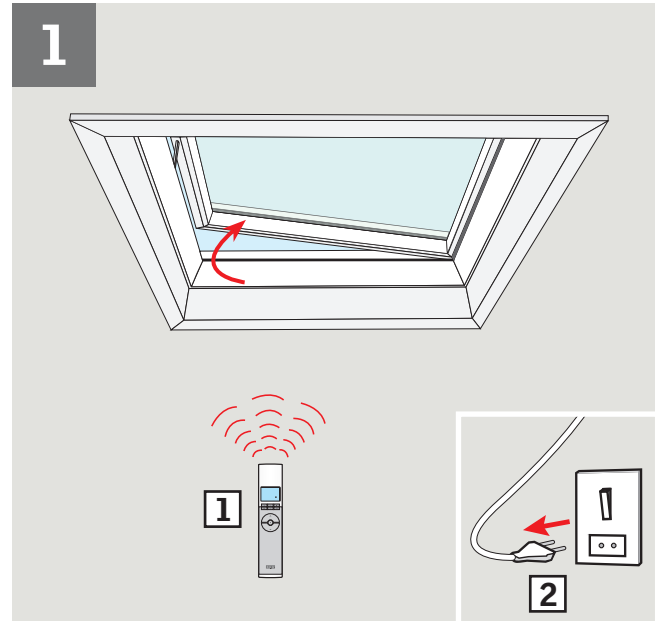
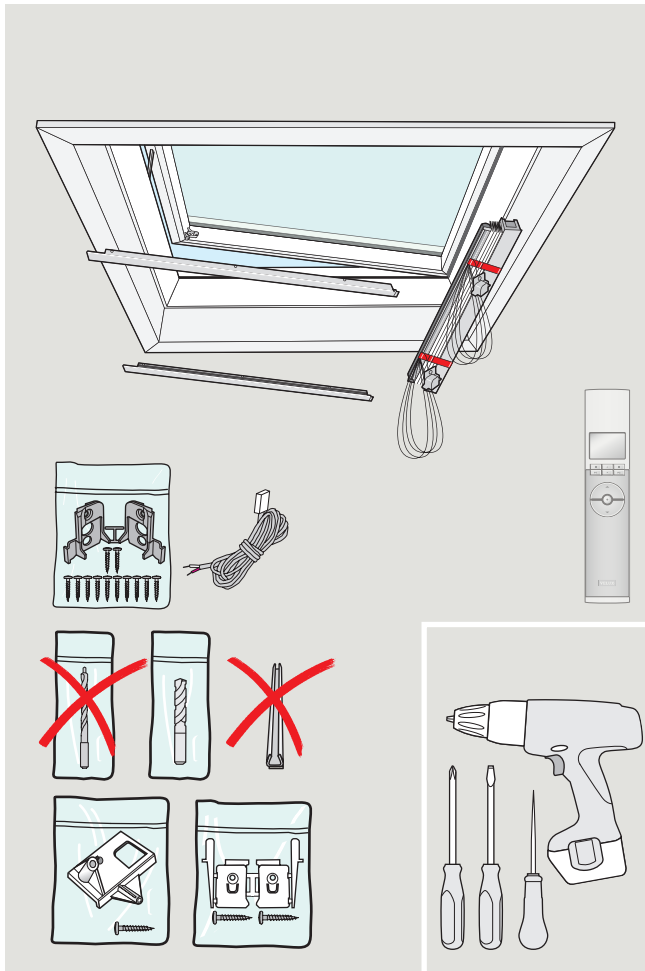

2

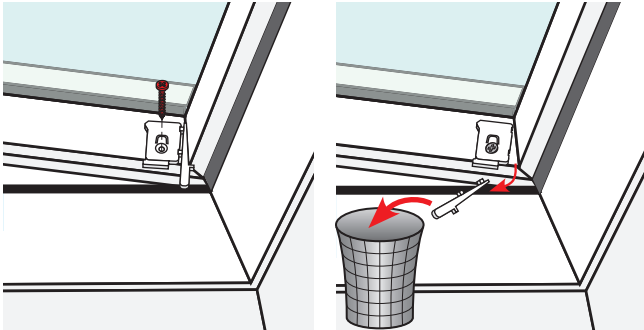
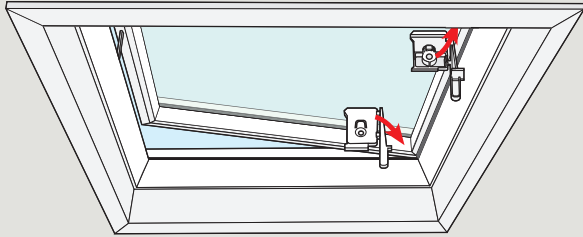

3

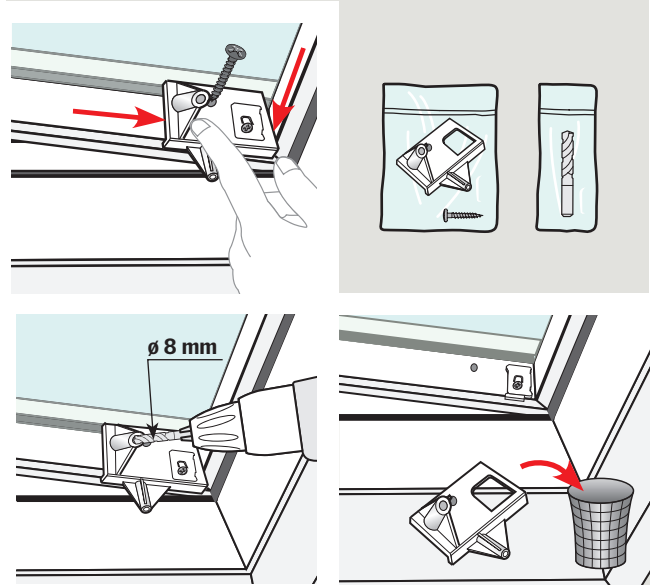
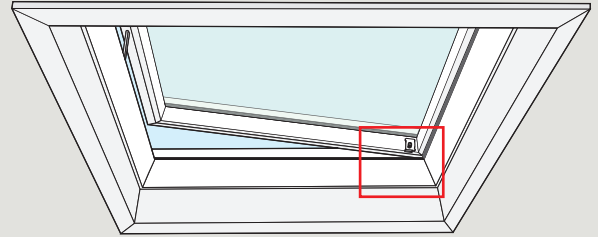

4

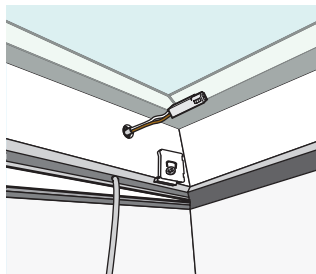
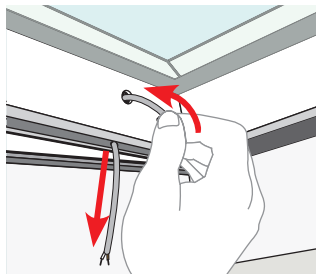
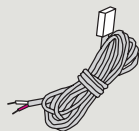
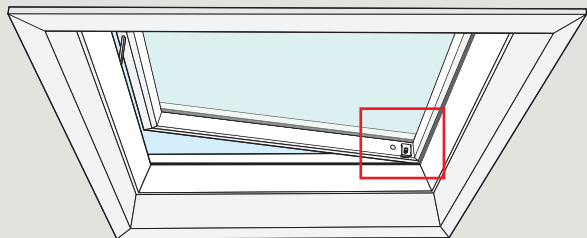

5

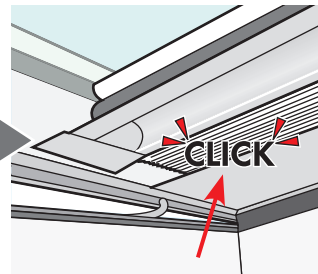
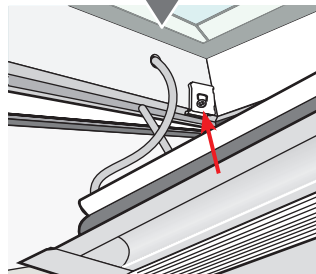
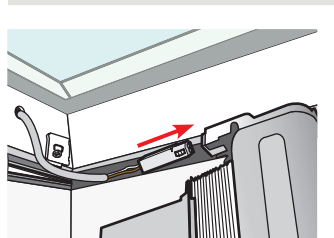
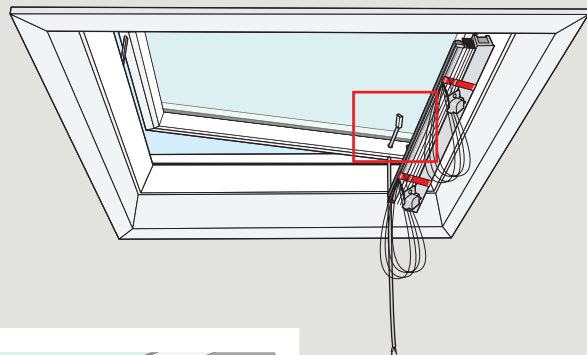

6

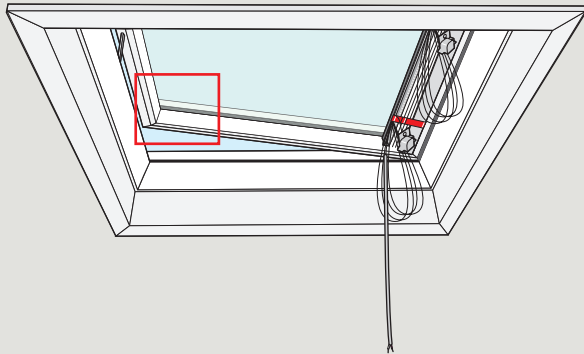

7

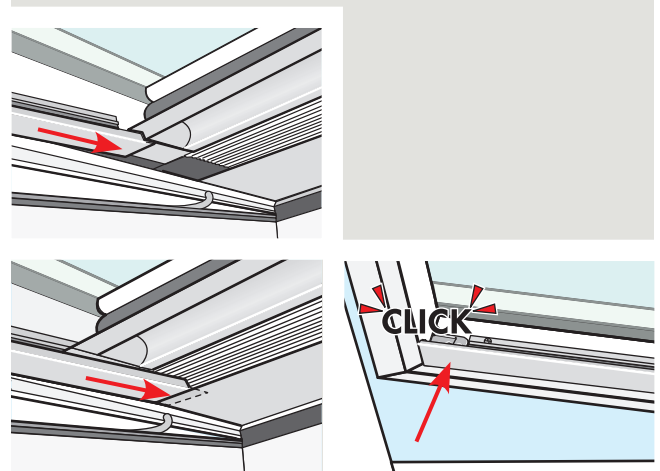
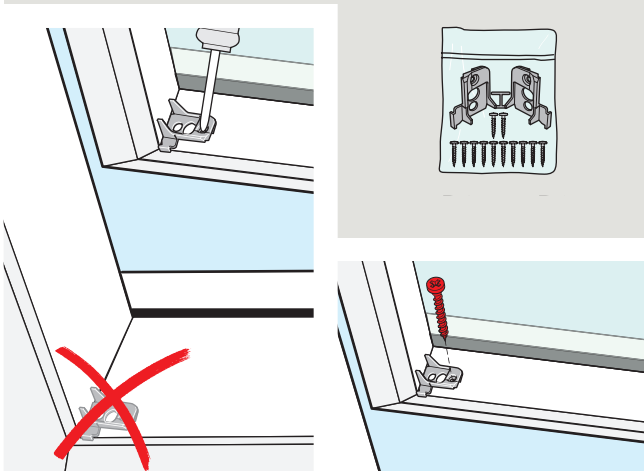
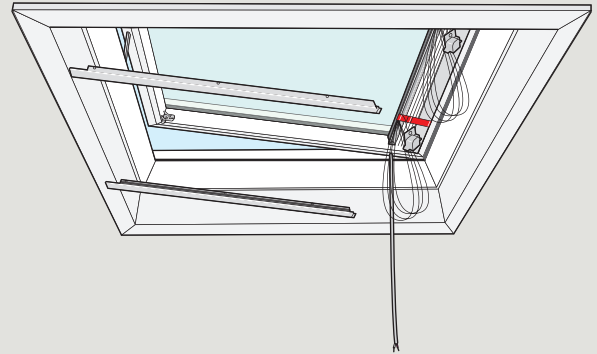

8

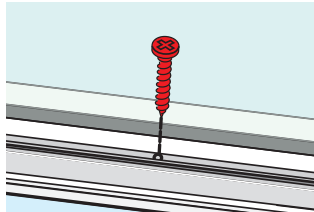
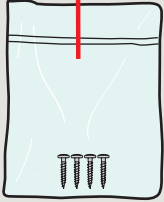
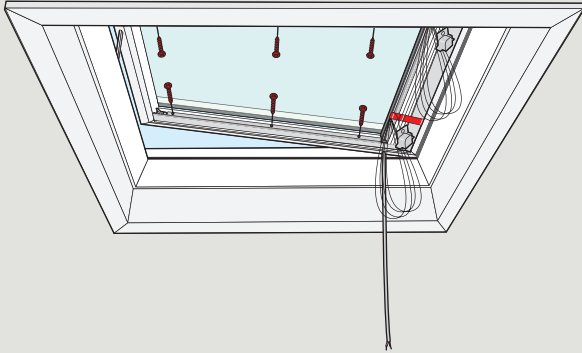

9

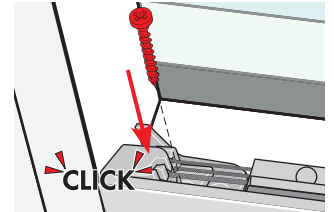
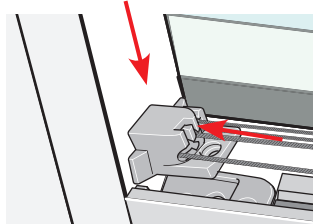
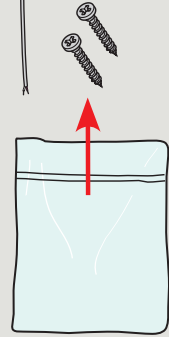
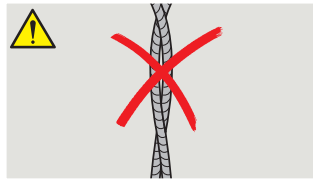
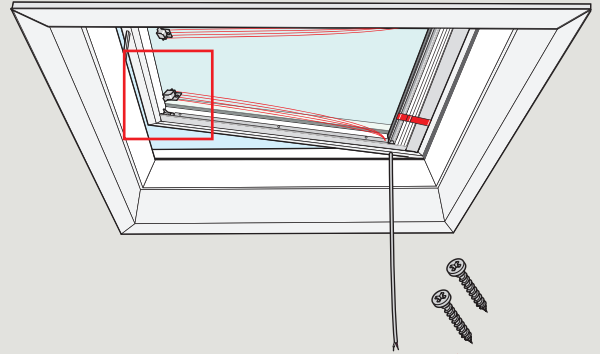

10

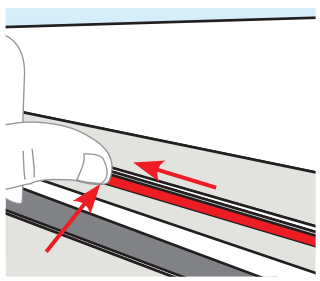
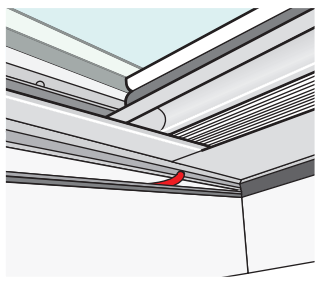
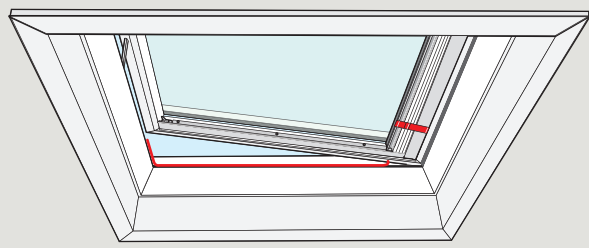

11

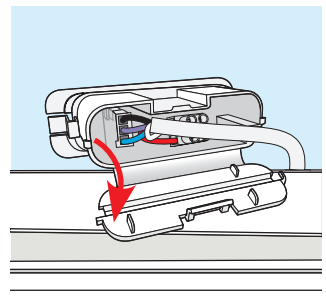
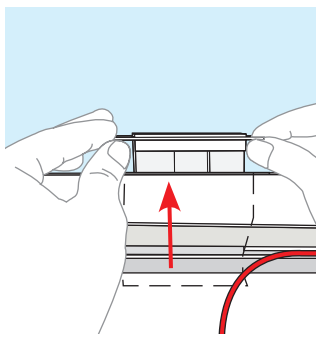
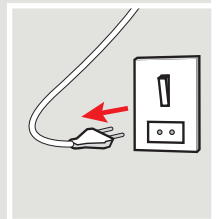
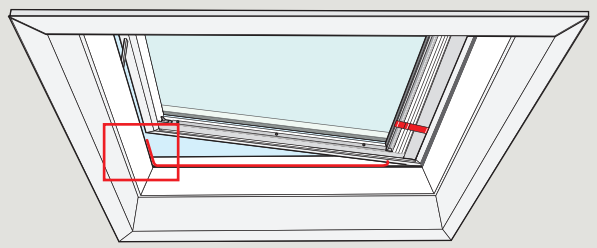



12

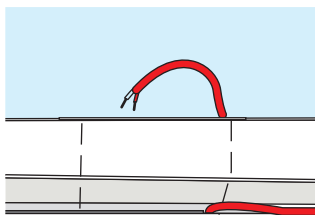
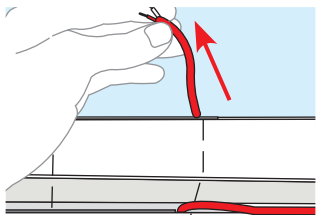
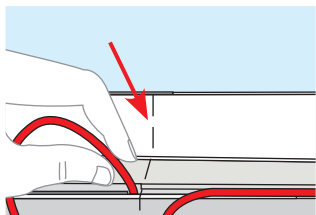
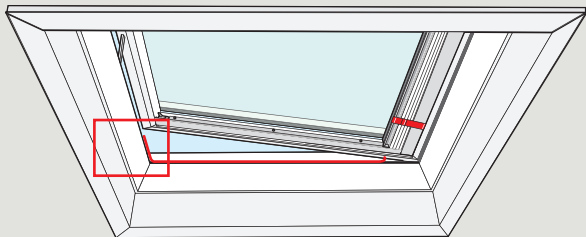

13

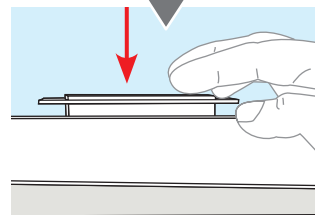
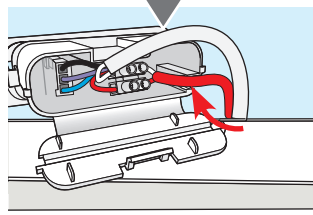
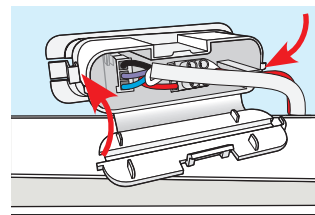
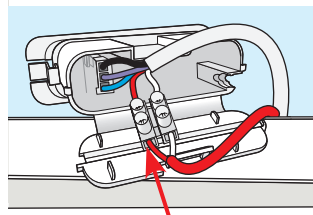
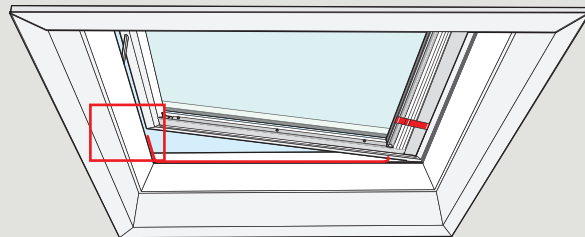

14

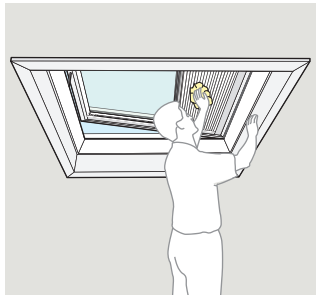
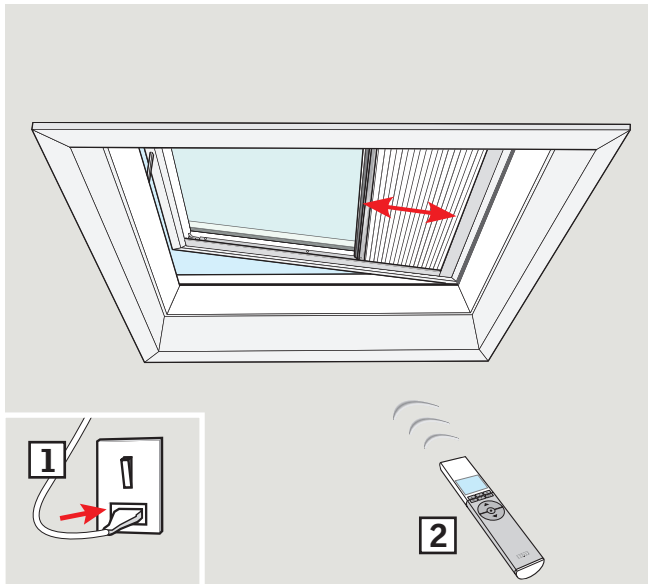
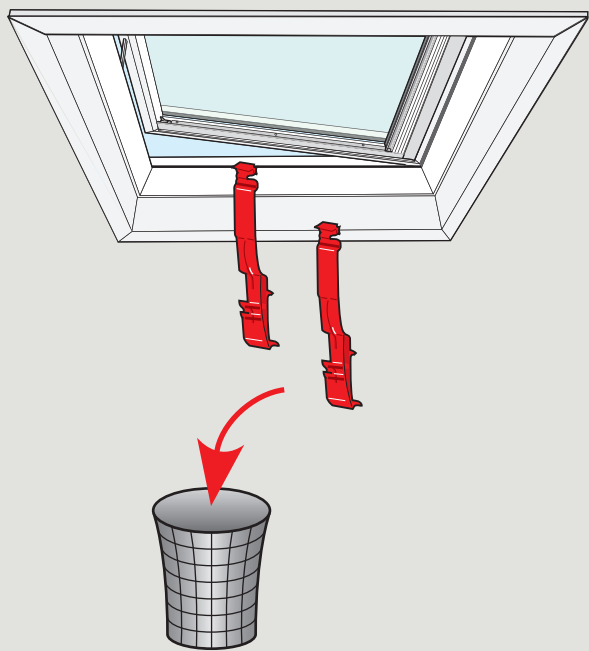

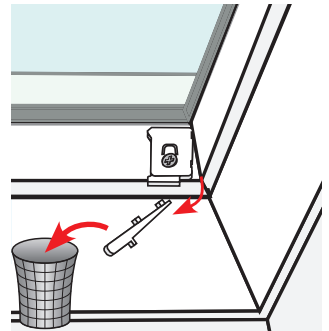
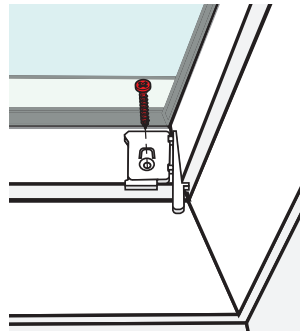
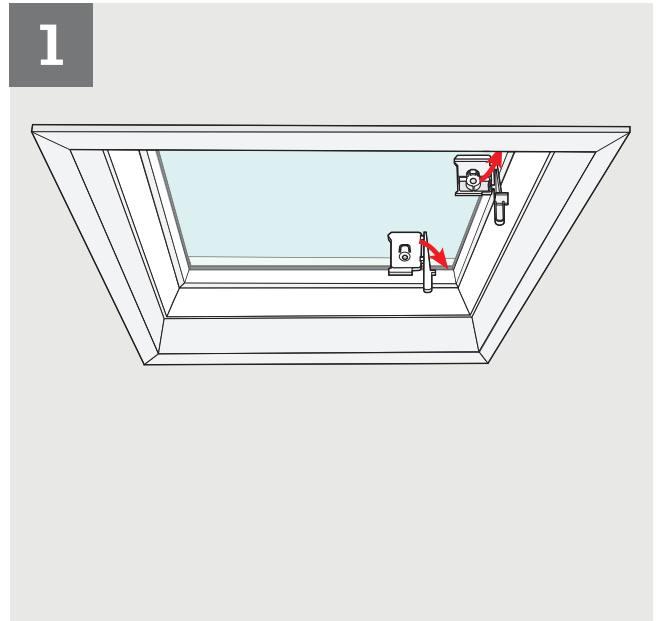
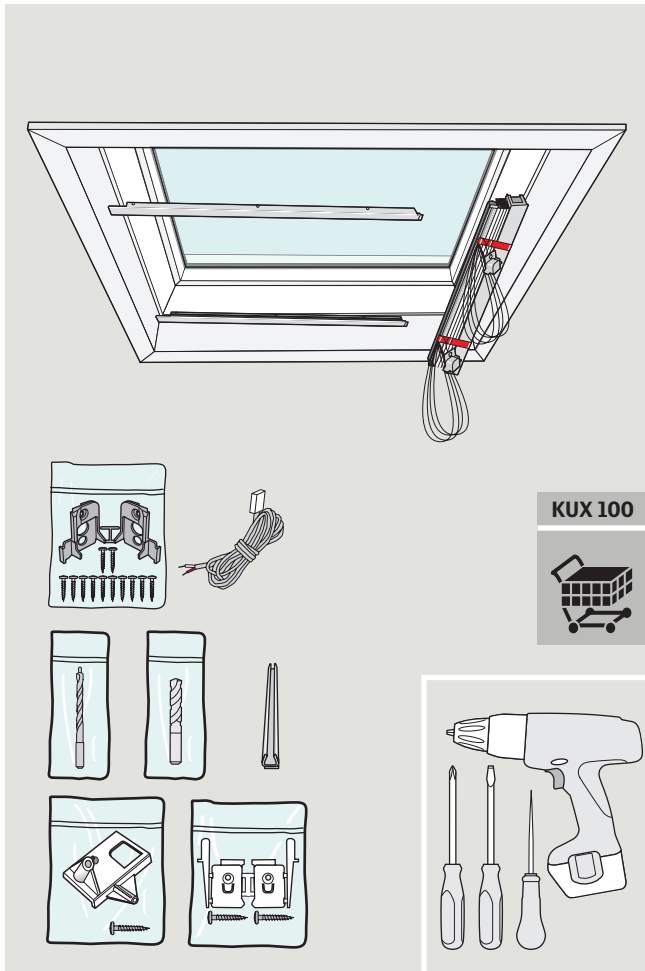

2

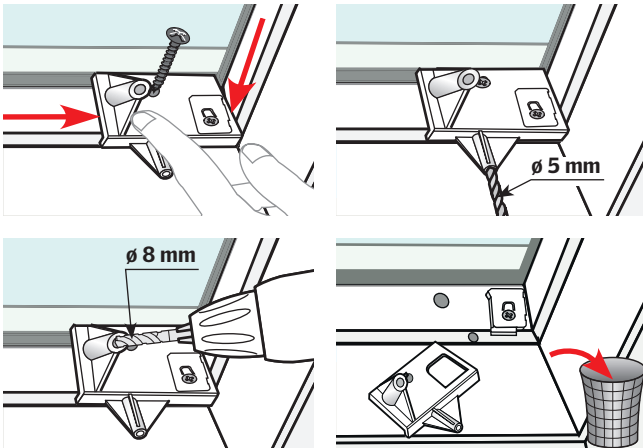
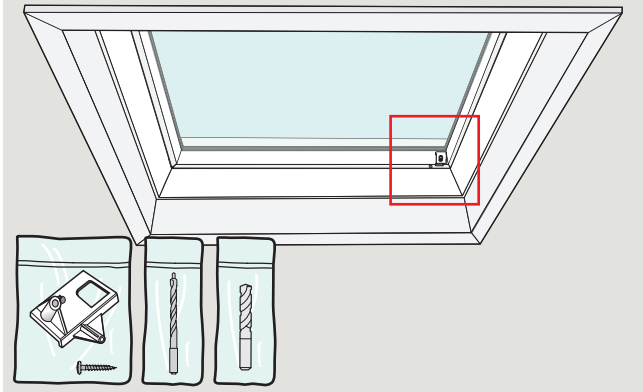

3

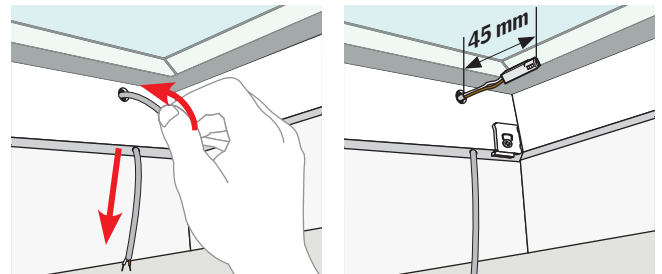
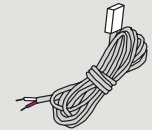
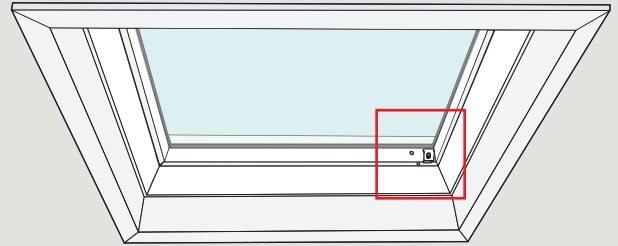

4

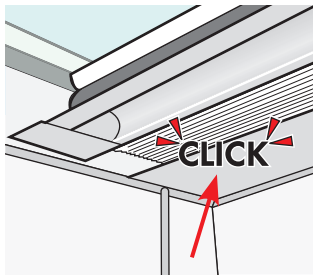
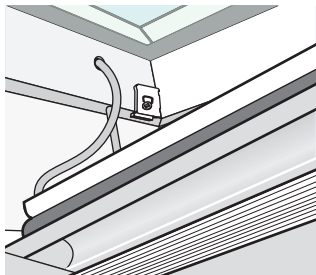
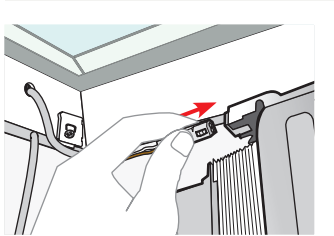
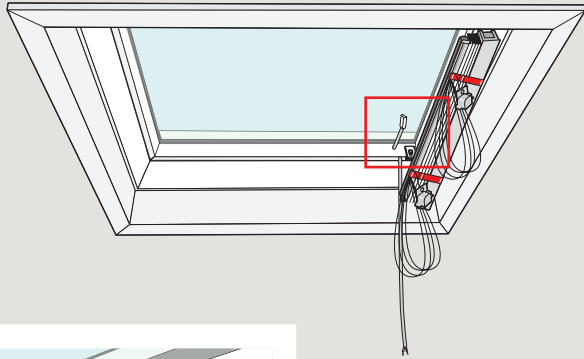

5

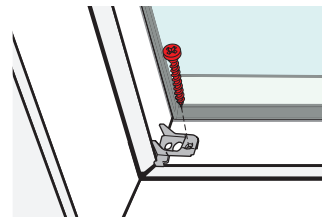
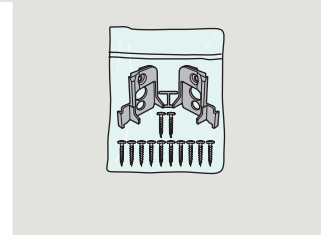
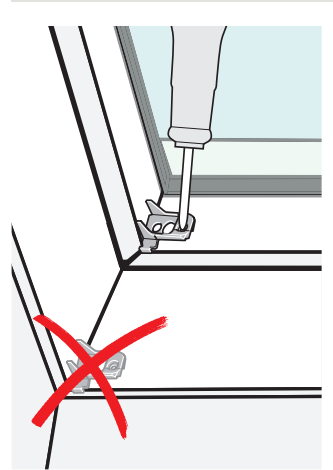
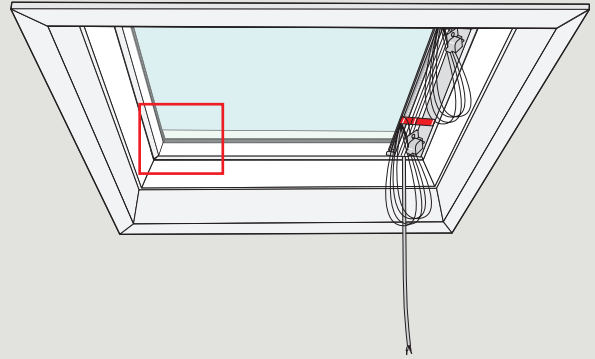

6

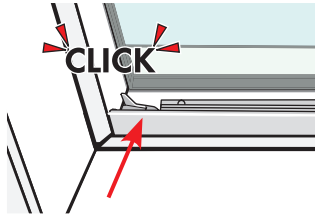
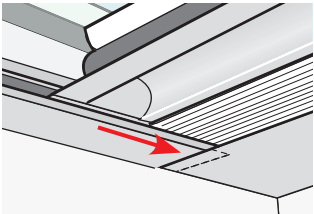
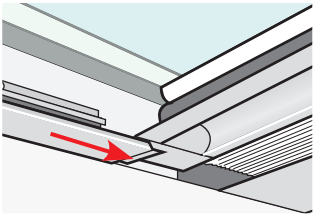
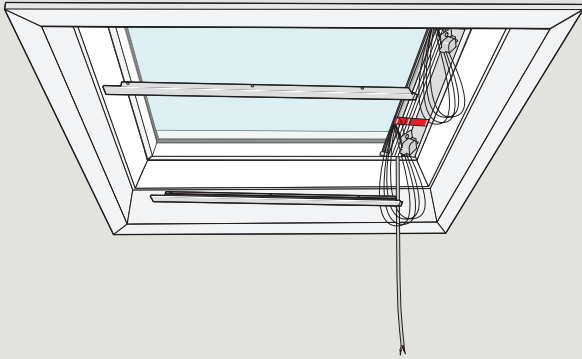

7

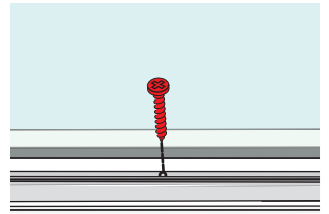
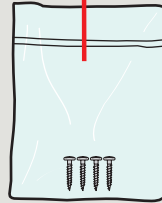
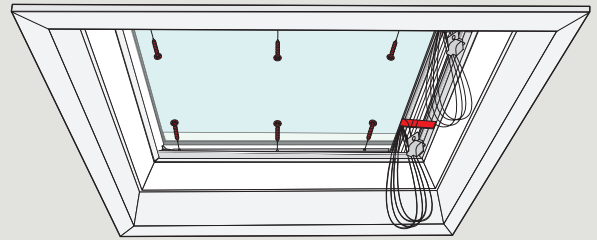

8

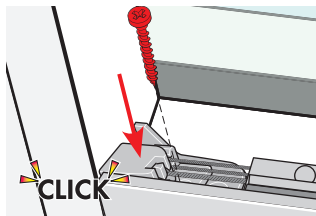
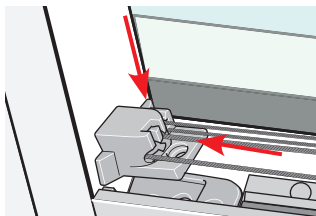
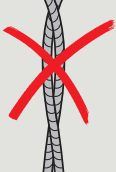
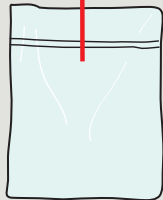
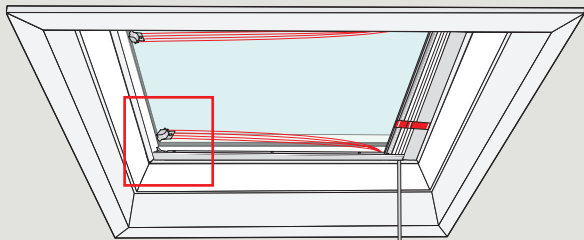

9

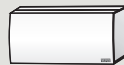
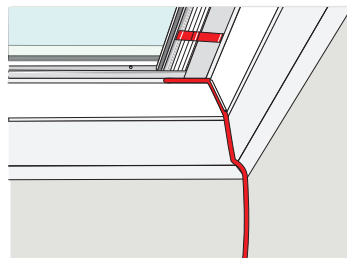
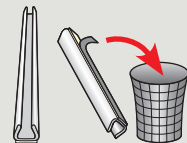
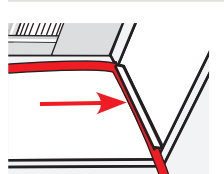
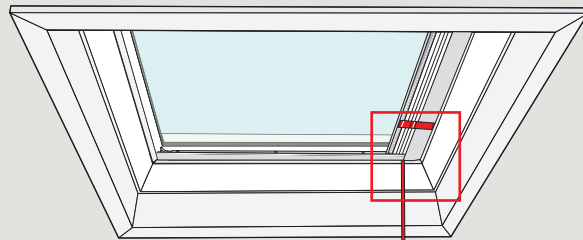

10

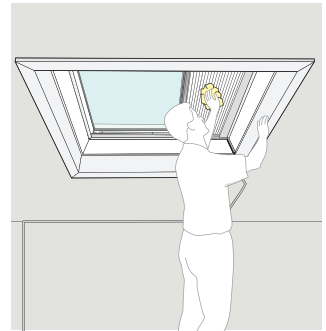
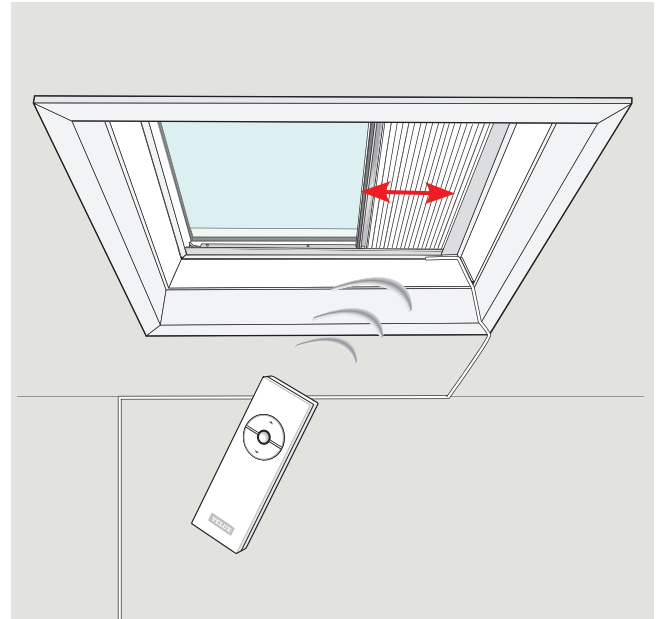
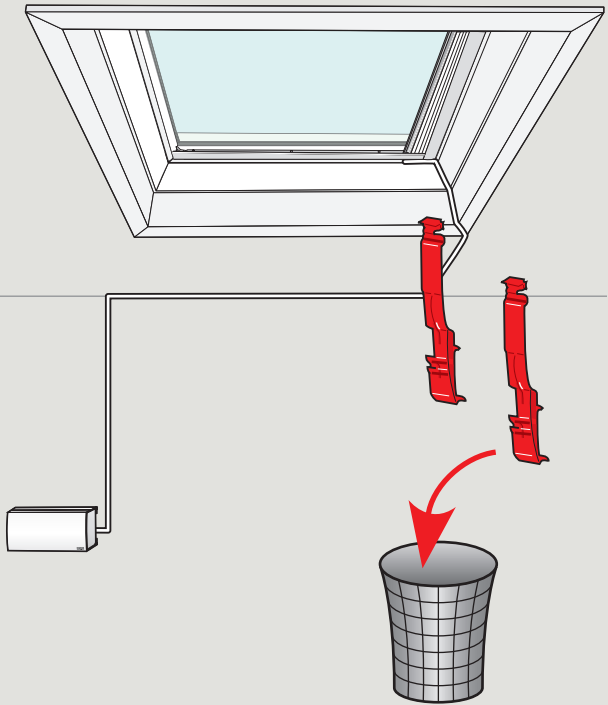



**VELUX®**

<b>AR:</b>	<b>VELUX Argentina S.A.</b> 348 4 639944	<b>HU:</b>	<b>VELUX Magyarország Kft.</b> (06/1) 436-0601
<b>AT:</b>	<b>VELUX Österreich GmbH</b> 02245/32 3 50	<b>IE:</b>	<b>VELUX Company Ltd.</b> 01 848 8775
<b>AU:</b>	<b>VELUX Australia Pty. Ltd.</b> 1300 859 856	<b>IT:</b>	<b>VELUX Italia s.p.a.</b> 045/6173666
<b>BA:</b>	<b>VELUX Bosna i Hercegovina d.o.o.</b> 033/626 493, 626 494	<b>JP:</b>	<b>VELUX-Japan Ltd.</b> 0570-00-8145
<b>BE:</b>	<b>VELUX Belgium</b> (010) 42.09.09	<b>LT:</b>	<b>VELUX Lietuva, UAB</b> (85) 270 91 01
<b>BG:</b>	<b>VELUX Bulgaria EOOD</b> 02/955 99 30	<b>LV:</b>	<b>VELUX Latvia SIA</b> 67 27 77 33
<b>BY:</b>	<b>FE VELUX Roof Windows</b> (017) 217 7385	<b>NL:</b>	<b>VELUX Nederland B.V.</b> 030 - 6 629 629
<b>CA:</b>	<b>VELUX Canada Inc.</b> 1 800 88-VELUX (888-3589)	<b>NO:</b>	<b>VELUX Norge AS</b> 22 51 06 00
<b>CH:</b>	<b>VELUX Schweiz AG</b> 0848 945 549	<b>NZ:</b>	<b>VELUX New Zealand Ltd.</b> 0800 650 445
<b>CL:</b>	<b>VELUX Chile Limitada</b> 2 953 6789	<b>PL:</b>	<b>VELUX Polska Sp. z o.o.</b> (022) 33 77 000 / 33 77 070
<b>CN:</b>	<b>VELUX (CHINA) CO. LTD.</b> 0316-607 27 27	<b>PT:</b>	<b>VELUX Portugal, Lda</b> 21 880 00 60
<b>CZ:</b>	<b>VELUX Česká republika, s.r.o.</b> 531 015 511	<b>RO:</b>	<b>VELUX România S.R.L.</b> 0-8008-83589
<b>DE:</b>	<b>VELUX Deutschland GmbH</b> 0800/3 27 27 27 Kostenlos aus dem deutschen Festnetz	<b>RS:</b>	<b>VELUX Srbija d.o.o.</b> 011 20 57 500
<b>DK:</b>	<b>VELUX Danmark A/S</b> 45 16 45 16	<b>RU:</b>	<b>ZAO VELUX</b> (495) 737 75 20
<b>EE:</b>	<b>VELUX Eesti OÜ</b> 621 7790	<b>SE:</b>	<b>VELUX Svenska AB</b> 042/20 83 80
<b>ES:</b>	<b>VELUX Spain, S.A.</b> 91 509 71 00	<b>SI:</b>	<b>VELUX Slovenija d.o.o.</b> 01 724 68 68
<b>FI:</b>	<b>VELUX Suomi Oy</b> 0207 290 800	<b>SK:</b>	<b>VELUX Slovensko, s.r.o.</b> (02) 33 000 555
<b>FR:</b>	<b>VELUX France</b> 0821 02 15 15 0,119€ TTC/min	<b>TR:</b>	<b>VELUX Çatı Pencereleri</b> Ticaret Limited Şirketi 0 216 302 54 10
<b>GB:</b>	<b>VELUX Company Ltd.</b> 01592 778 225	<b>UA:</b>	<b>VELUX Ukraina TOV</b> (044) 2916070
<b>HR:</b>	<b>VELUX Hrvatska d.o.o.</b> 01/5555 444	<b>US:</b>	<b>VELUX America Inc.</b> 1-800-88-VELUX

[www.velux.com](http://www.velux.com)