



# ALPHA 520

crimp to crimp



**komax**

## ALPHA 520

The Alpha 520 is a fully automatic crimp-to-crimp machine configured specifically for the industrial market. It is perfect for customers who want to produce small and large batch sizes and a very wide range of lengths, cross sections and wire end designs. Operation is intuitive and controlled by the proven Komax HMI system. Customers profit from a wide range of process modules and individual solutions.

### Versatile thanks to an enormous range of applications

With the multitalented Alpha 520, you will never miss a job. Whether small or very large quantities, delicate, heavy or very short cables, with the Alpha 520 you are ideally equipped for every challenge.

### Simple operation and efficient use guaranteed

Thanks to the intuitive Komax HMI control system, the operator can produce a wide variety of jobs after only a short familiarization period. In addition, the optimized operating concept of the Alpha 520 ensures even more efficient and safe setup directly at the machine.

### An investment that ensures your success for years to come

By combining durable design, long-term spare parts availability and flexible technology, Komax offers its customers the certainty that their investments will remain profitable in the long term.

### Promote automation now and in the future

The network-capable Alpha 520 can be integrated without great effort thanks to its modular platform and modern basic software. By networking your machine and regularly updating it, you benefit from the latest developments.

### High-level quality

With unique quality controls and standardized processes, the Alpha 520 offers fast, fully automated and highly precise processes. It helps you ensure the reliability and quality of your products to your customers.

OPTIMIZED FOR  
**INDUSTRIAL HIGH MIX  
PRODUCTION**



**C1370 / C1360 / C1340**  
CRIMP MODULE ; MOTORIZED Z-AXIS

\* on request



**S1441**  
SEAL MODULE



**X1582**  
TWISTING MODULE



**AEH-LS**  
FERRULE MODULE



**CM03\***  
MIL CRIMP MODULE



\* on request

**X1585**  
FLUXING/TINNING MODULE



**SLEEVE MODULE\***



\* on request

**DC**  
DOUBLE GRIPPER MODULE



**Always there for you – Komax Services**

- Available worldwide
- Komax Care service contracts
- Ramp-up & Relocation
- Feasibility test
- Financing

**VERSATILE THANKS TO AN ENORMOUS RANGE OF APPLICATIONS**

With the flexible, multitasking Alpha 520, you will never miss a job. With a wide range of processing options, the Alpha 520 can handle jobs with a variety of cables, effortlessly and economically. The changeover process is extremely efficient, allowing you to quickly switch between different jobs. Whether you process small or very

large quantities, delicate, heavy or very short cables, the Alpha 520 has a competitive solution for every challenge. Our services help you avoid downtime, provide fast and lasting troubleshooting in the event of an emergency, and tailor the machine to your needs. Optimal performance at a predictable cost.

**Unique processing spectrum**

The Alpha 520 processes conductor cross sections from 0.13 to 6 mm<sup>2</sup> with high precision. Cross sections from 0.05 mm<sup>2</sup> (AWG 30) are also possible on request. Even short wires from 20 mm (0.78 in) are easy to handle. With a wide range of process and quality modules that can be flexibly combined and adapted, the Alpha 520 offers individual solutions for the specific needs of each customer.

**Optimized for industrial needs**

With its flexibility and modular platform, the Alpha 520 offers a versatile and adaptable solution for various applications. The system remains highly standardized, which gives the customer significant advantages in spare parts handling and also in software upgrades.

**Motorized z-axis of the crimping modules**

The automatic height adjustment of the crimping module (available on request) ensures fast changeover and correct production right from the start, also with closed terminals in particular. The correct article specific height can be stored in the HMI, and the entire crimping module is automatically raised or lowered to the correct position.

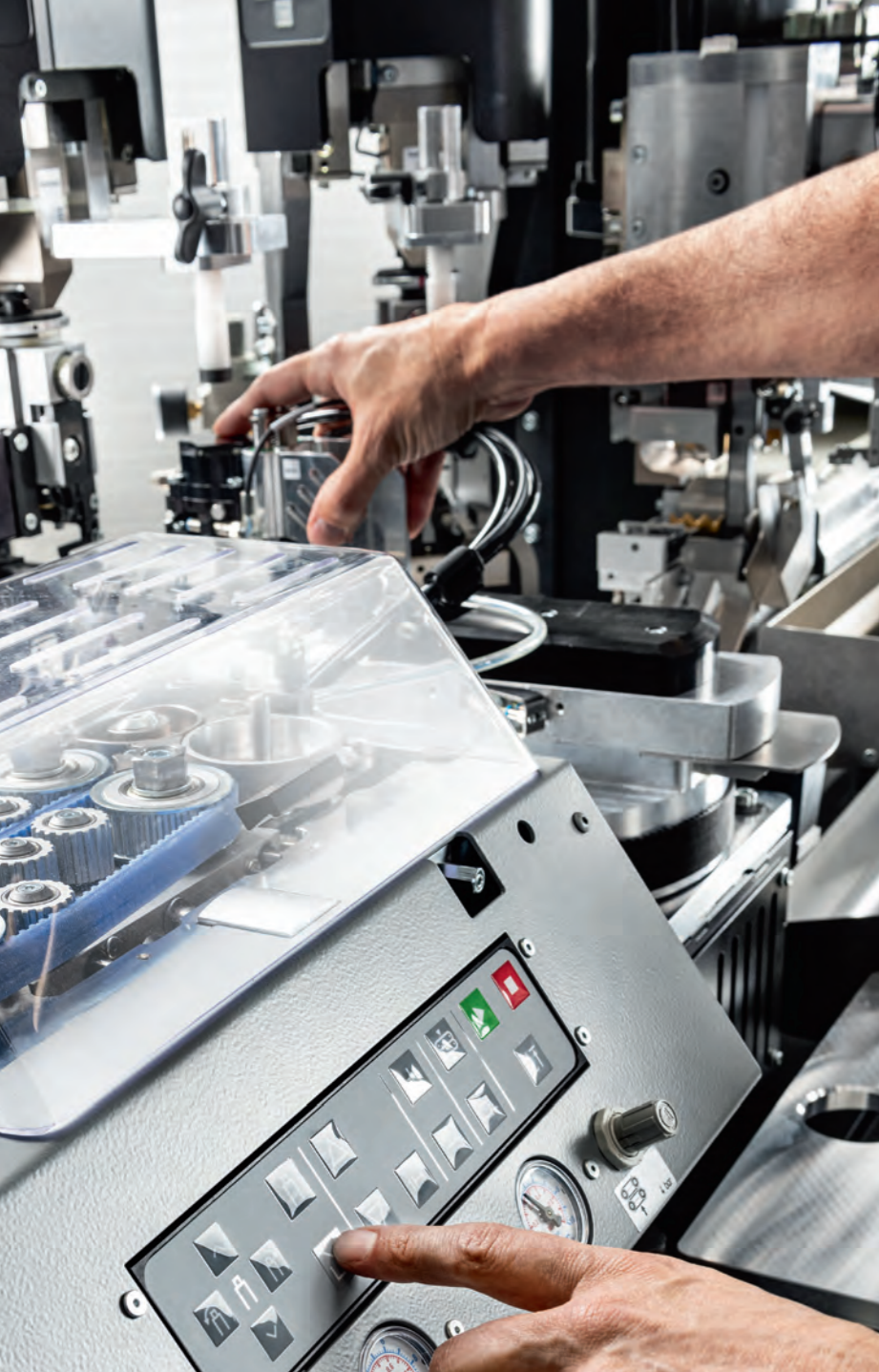

## SIMPLE OPERATION AND EFFICIENT USE GUARANTEED

Alpha machines are simple. After a short training period, your employees will be able to produce a wide variety of jobs on the machine efficiently and with pleasure. The Komax HMI control system is intuitive and clear. Workflows guide the operator through the process with clear instructions. Individual dashboards

provide a perfect overview of machine performance or enable simplified operation. The Alpha 520's optimized operating concept also makes setup at the machine more efficient and safer. Training solutions help you educate and develop your staff, creating a productive environment for operation and maintenance.

01

### Guided workflow and additional functions

The intuitive user interface makes the operation fast to learn and easy to operate. The Komax HMI operating software guides the operator step by step along the workflow. Additional steps – like extra samples or quality verifications can easily be integrated. The optional machine dashboard provides additional functions with specific benefits, for example job list optimization or repeated production of a previous article. The customizable dashboards help to increase the transparency, efficiency and productivity.

### Simple, efficient and safe setup and material changeover

The setup concept on the Alpha 520 is intuitive, efficient and exceeds the latest safety standards. When the safety cover is open, the drives are safely switched off (e.g. crimp modules). The swivel arm is moved to the desired position by hand and confirmed by pressing a button (hand-teaching). With the safety cover closed, the wire position can be adjusted using one of the three control panels distributed throughout the base machine.

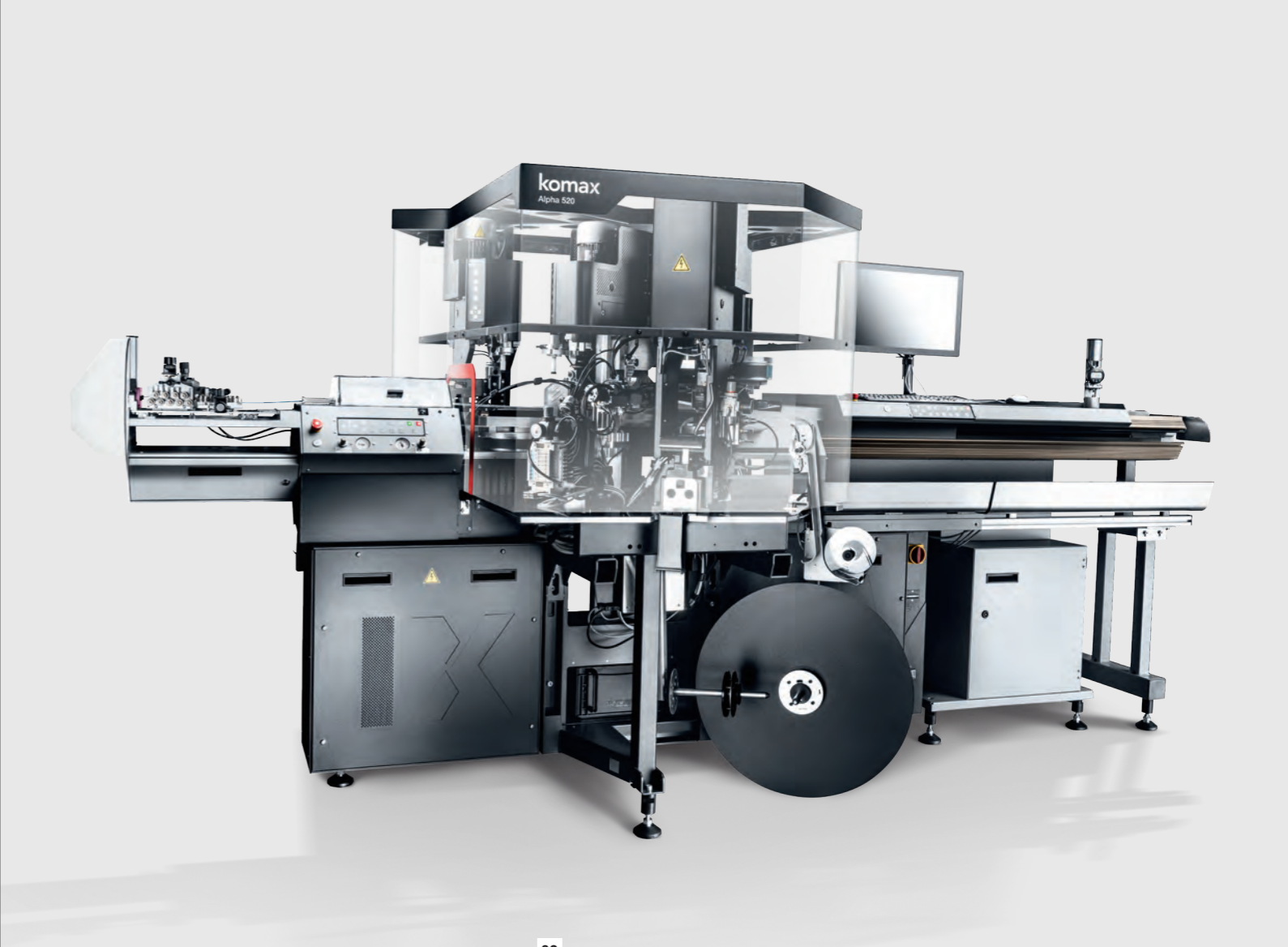

02  
03

- 01** Optimized setup process with "hand-teaching" – quick and adjustment by hand with the inactive system.
- 02** Automate various work steps, e.g. twisting strands, tinning, double crimping.
- 03** Intuitive HMI control system that provides workflows to guide the operator.



### Komax Services Upgrades & Enhancement

- Production analysis
- Upgrades and enhancements
- Consulting

### Modular platform for high flexibility

The Alpha 520 is based on our latest modular platform, which is also used on other Alphas. This platform offers the possibility of equipping the machine with new functions or modules at any time. More than four modules can be integrated at the customer's request.

### Ready for the future

Through common parts strategy, spare parts management is greatly simplified. The platform is ready for the future, i.e. ready for integration into MES systems or for connectivity. Your investment remains protected for a long time because you are also optimally equipped for future automation solutions.

### Customer-specific and individual

Customized programming of the dashboard is possible upon customer request. This helps to optimize processes, improve transparency and increase efficiency and productivity. Komax solutions are flexible and can be further developed and adapted as needed to meet the changing needs of our customers.

### Komax Services keeps your machine fit and efficient

- Maintenance
- Repair
- Emergency plans

**01**  
Modular platform for high flexibility. More than four modules can be integrated at the customer's request.

**02**  
Intuitive user interface with customizable dashboards to increase efficiency and transparency.

## AN INVESTMENT THAT ENSURES YOUR SUCCESS FOR YEARS TO COME

The Alpha 520 is designed to optimally meet the diverse requirements of industry and guarantee consistently high performance over many years. The proverbial longevity of Komax machines, the availability of spare parts for decades, and future-oriented technology with a wide range of

expansion options ensure that you will be able to meet all your customers' requirements economically in the future as well. Komax Care service contracts help you keep your machines in perfect working order and at the cutting edge of technology.

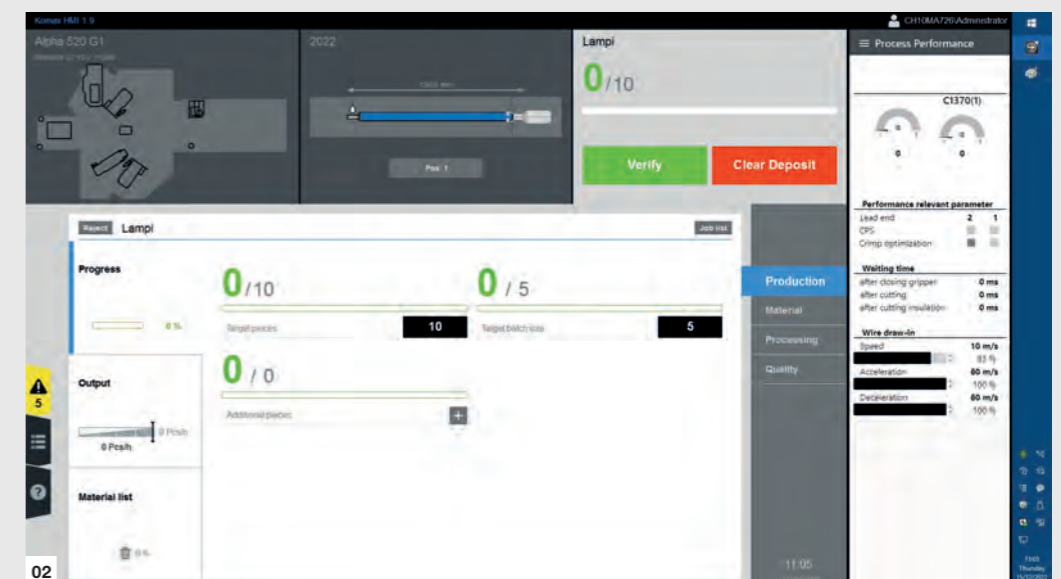
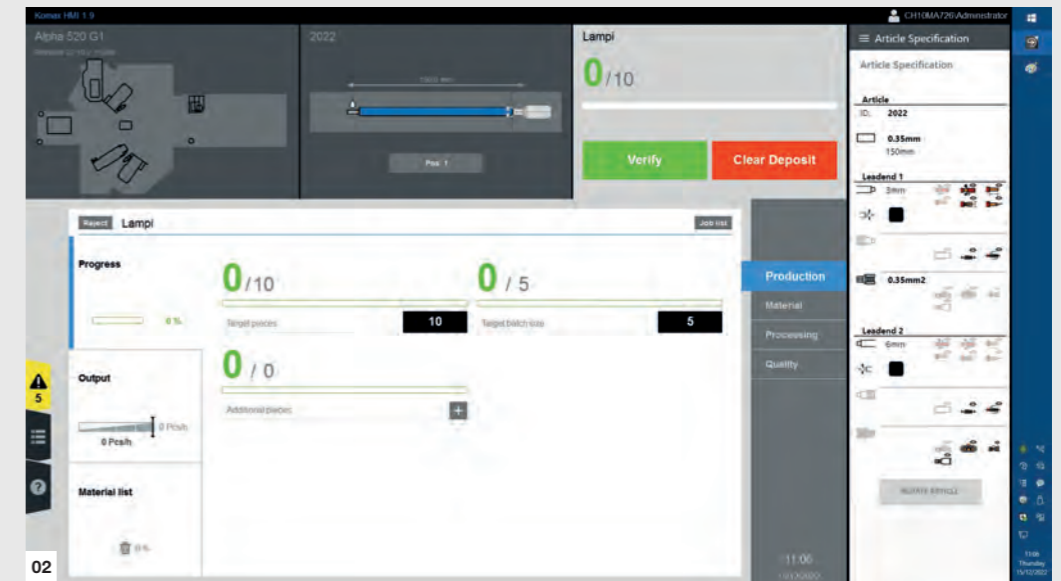

01

02



## PROMOTE AUTOMATION NOW AND IN THE FUTURE

Automation brings enormous benefits – and you are ideally equipped to take advantage of them. The Alpha 520 is network-capable and can be easily integrated into an existing control system. Additional modules can be integrated into the machine without having to change the machine's software base.

This allows you to expand your automation at any time while benefiting from a stable solution and regular standard updates. By networking your machine and regularly updating, you can keep track of all important parameters and benefit from the latest developments.



### Expandable software

The expandable software allows seamless integration of new software to control a new component with no need to change the base software. This software is highly compatible and can therefore benefit from all system updates. In addition, it is possible to program customer-specific processes on request.

### High connectivity

The networkable architecture of the Alpha 520 is based on our modular platform, which can be perfectly integrated into a production control system such as Komax MES. Thanks to its modular design and adaptable software, the Alpha 520 offers you a future-proof basis for the further automation and networking of your machinery. By networking your machine and regularly updating it, you can keep an eye on all the important parameters and benefit from the latest developments.



### Komax Services Upgrades & Enhancement

- Production analysis
- Upgrades and enhancements
- Consulting



## HIGH-LEVEL QUALITY

Your customers value the reliability and quality of your products. The Alpha 520 helps you achieve this by executing the processes you define quickly, fully automatically and with maximum precision. Possible sources of error, such as operator influence, are reduced to a minimum through

quality controls and standardized processes. This allows you to set standards for your customers. With the service contract Komax Care Optimize, our experts also help you to continuously improve production and reliably meet even the highest requirements.



01  
02

03

**01**  
The motorized pullout-force measuring device Q1210 measures pullout forces at a defined pull-off speed to measure forces from 20 to 1000 N.

**02**  
The quality characteristics of each crimp are checked optically by the Q1250 scalable.

**03**  
The Komax 341 crimp height measuring device measures a contact pattern during the setup process and compares it with the target crimp height. If necessary, the crimp height is then automatically corrected to the target crimp height (only possible with C1360/C1370).

### Komax Services for high precision and proven quality

- Komax Care service contracts
- Installation & Ramp-up
- Inspection & Calibration

### Excellent quality concept

Thanks to the integrated quality monitoring and quality inspection as well as the traceability of production, precise manufacturing is ensured. The quality controls and standardization of the machine processes minimize the operator's influence on quality. Among other things, the scalable Q1250 module visually checks for correct stripping, the presence of crimps or seals, and the correct execution of each crimp and crimp-and-seal operation.

### Numerous options for perfect quality and minimal waste

- Optical quality monitoring – Q1250 scalable
- Crimp-height verification – Komax 341
- Pull-off force verification – Q1210
- Microscope – Komax 345
- Barcode scanner
- Splice detection



01  
02

# CUSTOMIZED AUTOMATION

PRECISELY TAILORED TO  
YOUR SPECIAL PRODUCTION  
CHALLENGES

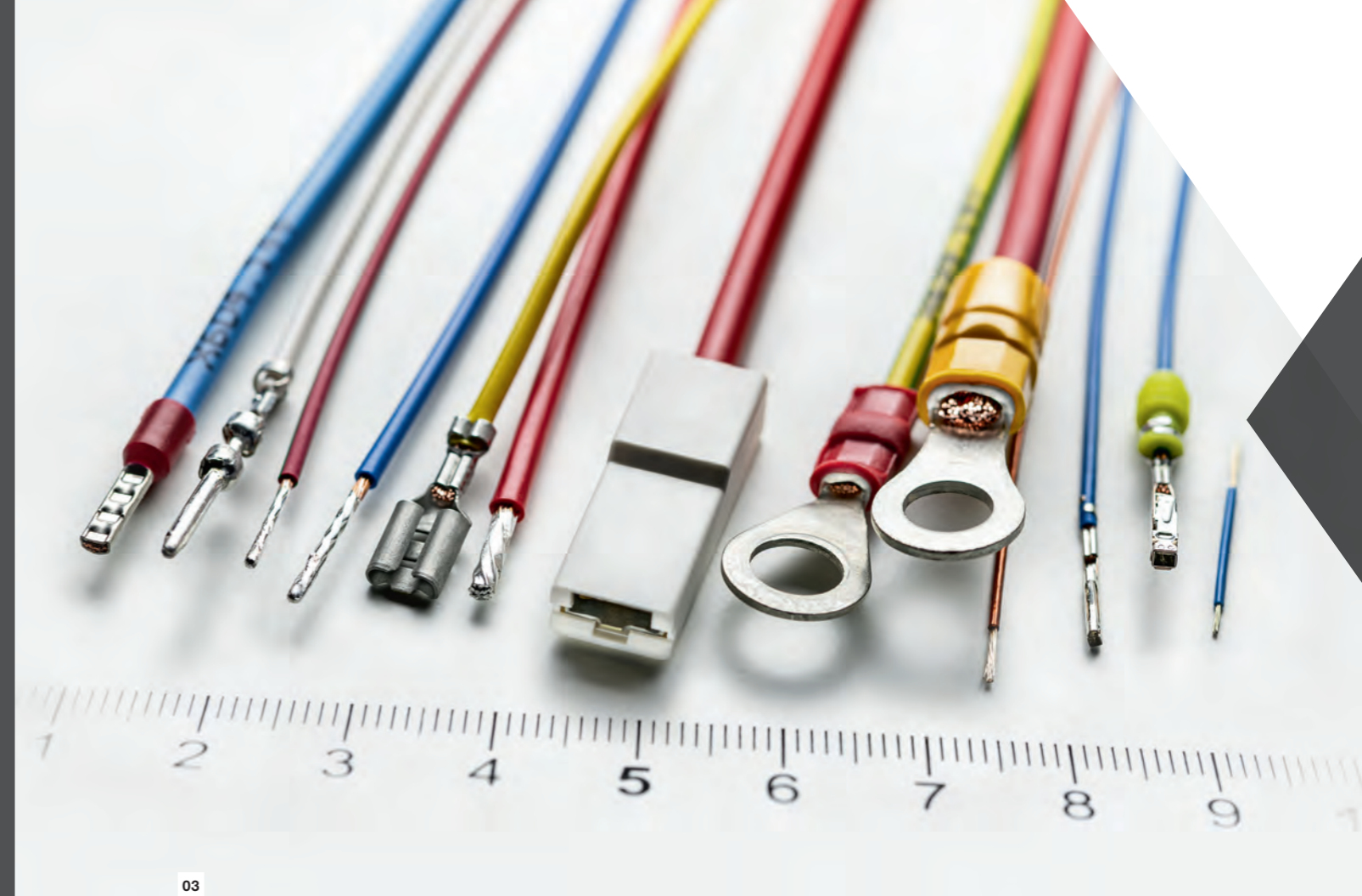

03  
04



- 01** Integration of a Mira multilayer strip device on the Alpha to operate special wires. Simplify your work and get more efficient and economical with our customized solutions.
- 02** Side-by-side blade holder for thin, short wires.
- 03** Alpha 520 offers a very wide range of wire end processes and even very short and thin wires.
- 04** The reliable and durable belt drive allows quick wire change with simple and efficient wire feed-in.

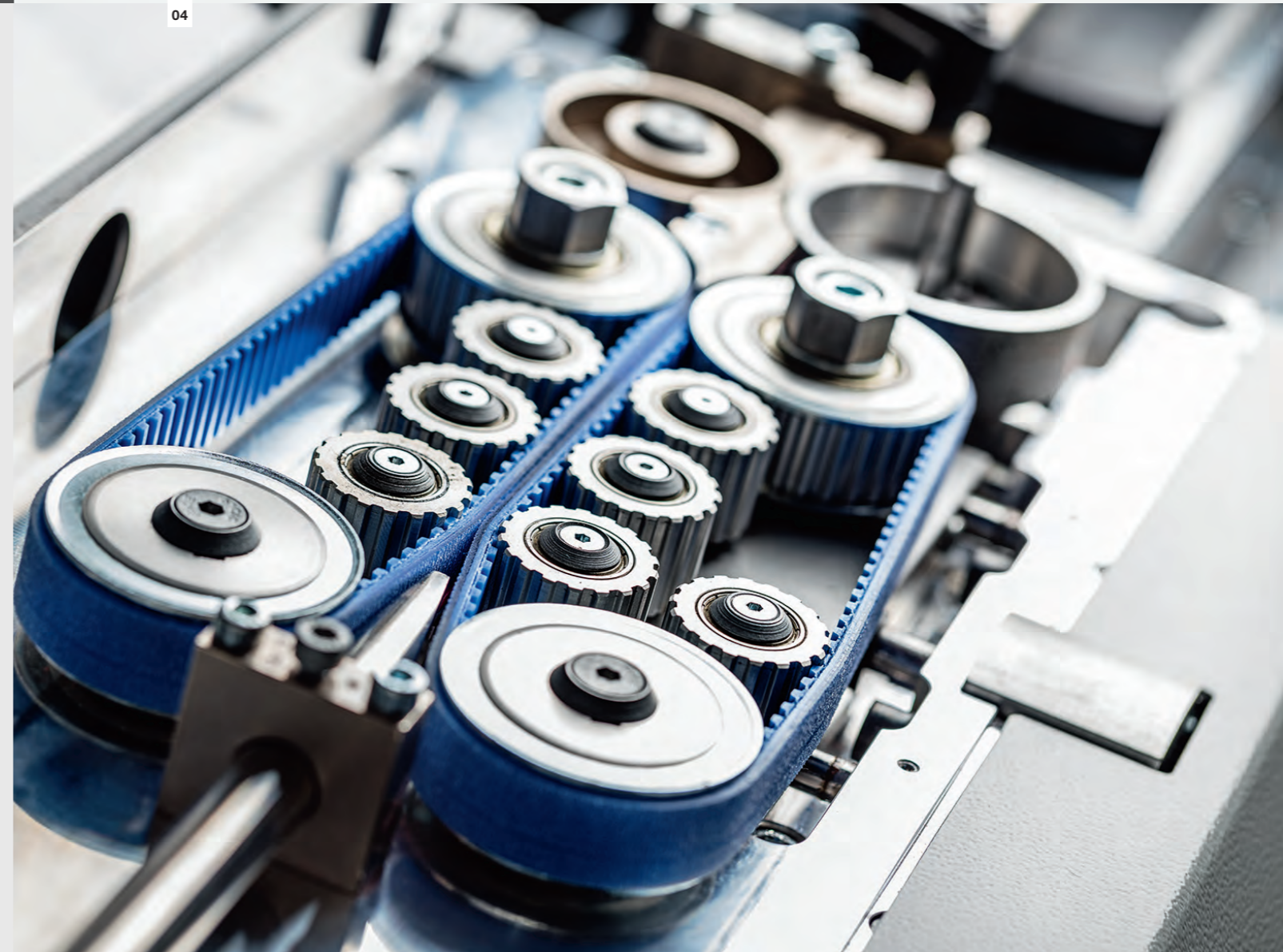



## Technical data

Wire cross section*	0.05 – 6 mm <sup>2</sup> (AWG 30 – 10)
Wire draw-in speed	max. 10 m/s (33 ft/s)
Outside diameter of conductor	max. 5.1 mm (0.20 in.)
Wire length**	20 – 65,000 mm (0.88 in – 213 ft)
Full stripping	0.1 – 30 mm (0.004 – 1.18 in)
Partial stripping	0.1 – 29 mm (0.004 – 1.14 in)
Crimp force	1 – 22 kN (224 – 4946 lbf)
Process modules	Side 1: 2 Side 2: 2 On request more stations possible
Noise level (w/o crimping)	< 80 dB (w/o applicators)
Electrical connection	3 × 208 – 480 V / 50 – 60 Hz / 5 kVA
Compressed air connection	5 – 8 bar (73 – 116 psi.)
Air consumption Crimp / crimp crimp-seal / crimp-seal	< 7 m <sup>3</sup> /h (247 ft <sup>3</sup> /h) < 11 m <sup>3</sup> /h (388.5 ft <sup>3</sup> /h)
Weight (incl. 2 crimp modules)	1.3 t (2866 lbs.)

\* Cross sections < 0.13 mm<sup>2</sup> / > AWG 26 available as application after feasibility test. Also larger wire cross sections are possible on request after feasibility test. Very hard and tough wires may not be able to be processed even if within specification. Komax can arrange feasibility tests for prior evaluation.  
\*\* Tolerance of wire lengths ±(0.2% + 1 mm (0.039 in))  
Deposit length > 12 m on request

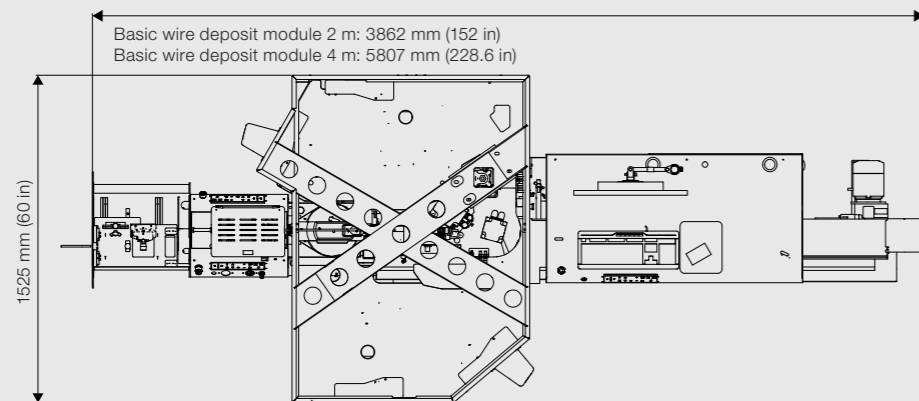

Height with cover closed: 1790 mm (70.5 in)  
Height with cover completely open (maximum opening): 2790 mm (109.8 in)



01



02

**01**  
Quick change of the guide tubes without tools.  
**02**  
The tools are within reach at any time in the practical, lockable drawer situated directly under wire draw-in.



## Options and accessories

Automatic wire handling	F1110 • F1150 • ads 1xx
Marking systems	Komax 26 hot-stamp marker • Komax inkjet marking systems • Laser marking on request
Blade holder	Side-by-side blade holder
Process modules	C1370/C1360/C1340 crimp module • S1441 seal module • Double gripper module • X1582 twisting module • X1585 tinning module • AEH ferrule module  Possible on request: sleeve module • MIL crimp module • Welding module • Ultrasonic compaction and many more.
Quality control	Crimp Force Analyzer CFA/CFA+ • Integrated crimp-height measurement • Integrated pullout-force measurement • Q1250 scalable optical stripping, seal and crimp monitoring • Material change detection • Material verification • Splice detection • Terminal end detection • Q1140 spark tester on request
Deposit systems	Basic module 2 m (78.7 in) or 4 m (157.5 in) Extension module 2 m (78.7 in) or 4 m (157.5 in)
Accessories	Quick-change wire draw-in • Barcode scanner • Intermediate stripping on request
Software	Komax HMI • Komax MES • MIKO networking interface • WPCS/MIKO Converter

## Processing examples

Cutting to length		Split cycle for closed terminals	
Cutting pulled strands		Seal insertion	
Full stripping		Twisting/tinning	
Partial stripping		Sleeve insertion*	
Core processing*		Ferrule crimping	
Double casing, coaxial and triaxial cables*		MIL crimping*	
Center stripping*		Wire-end compaction, splicing, welding*	
Crimping		Hot-stamp marking*	
Double crimping		Inkjet marking	

\* Available on request

# KOMAX SERVICES

Gaining operational flexibility and production assurance at minimum cost throughout the machine's lifetime.

## MODERNIZE

**Upgrades + Accessories**  
"Leverage innovation to improve performance"

## SUPPORT

**Komax Direct, Remote Support, CARE Remote, Feasibility Checks**  
"Easy access to our experts"

## REPAIR

**CARE Warranty, Field + Original Parts Services**  
"Services to get you back to business quickly"

## PRESALES

**Consultancy + Configuration Support**  
"Solution tailored to your specific needs"

## FINANCING

**Alternative + Flexible Packages Available**  
"Designed to meet your financial needs"

## INSTALL

**Acceptance Tests + Ramp-up Support**  
"Ensure a perfect start"

## DIGITAL SOLUTION

**WIRE Insights + data2wire**  
"Keep control of performance"

## TRAINING

**On.Site, On.Line + On.Class Trainings**  
"Build a qualified and adaptable team"

## MAINTENANCE

**CARE Maintain, Field + Original Parts Services**  
"Ensure production capacity at predictable cost"

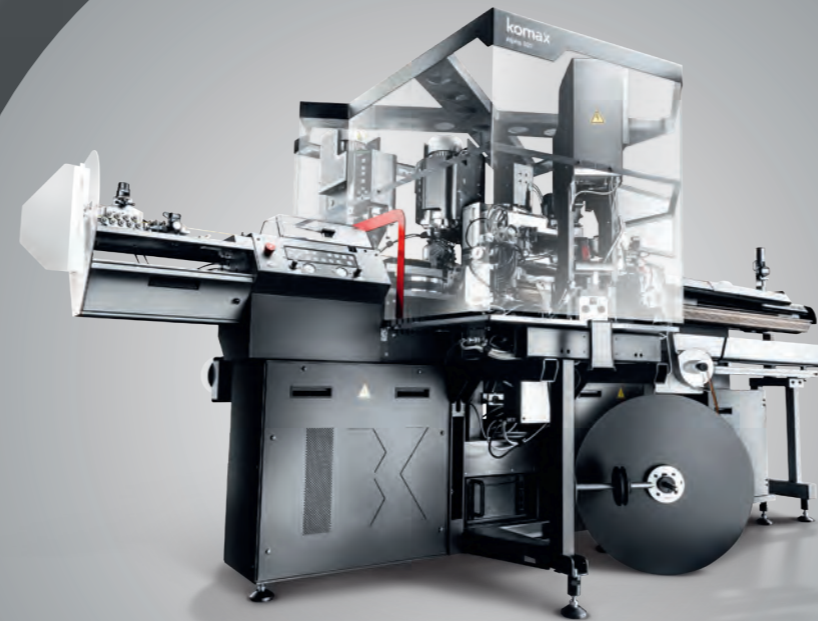

## KOMAX SERVICES REDUCE TOTAL COST OF OWNERSHIP

By using the same or similar parts, we can offer you our high-quality machines and spare parts at an attractive price. Fewer different spare parts also means much simpler spare parts handling

for you and much greater efficiency in maintenance. Your spare parts procurement and inventory will be greatly simplified. Service technicians only need to be familiar with a limited

number of components, which significantly increases maintenance efficiency. This saves money, minimizes downtime and optimizes machine productivity.

At Komax, our focus is on providing our clients with the best possible service and support. Therefore, don't hesitate to contact your local Komax partner to learn more about Komax Services.



## Komax – leading the field now and in the future

As a pioneer and market leader in automated wire processing, Komax provides its customers with innovative solutions. Komax manufactures series and customer-specific machinery, catering to every degree of automation and customization. Its range of quality tools, test systems, and intelligent software and networking solutions complete the portfolio, and ensure safe, flexible, and efficient production.

Komax is a globally active Swiss company with highly qualified employees and development and production facilities on several continents. It provides local support to customers worldwide through its unique sales and service network and offers services that help them get the most out of their investments.

Komax AG  
Industriestrasse 6  
6036 Dierikon, Switzerland  
Phone +41 41 455 04 55  
sales.din@komaxgroup.com

**komax**  
komaxgroup.com