

# Annual Comprehensive Financial Report

YEAR ENDED DECEMBER 31, 2022



*JOE HOGSETT, MAYOR*  
*SARAH RIORDAN, CONTROLLER*

## City of Indianapolis, Indiana

(COMPONENT UNIT OF THE CONSOLIDATED CITY OF INDIANAPOLIS-MARION COUNTY)



**ANNUAL  
COMPREHENSIVE  
FINANCIAL  
REPORT**

**City of Indianapolis, Indiana  
(A Component Unit of the Consolidated City of Indianapolis – Marion County)**

**Year Ended December 31, 2022**

**Office of Finance and Management**

**(This page intentionally left blank)**

# TABLE OF CONTENTS

	<b>Page(s)</b>
<b>I. INTRODUCTORY SECTION (UNAUDITED)</b>	
Letter of Transmittal	I – IX
Certificate of Achievement for Excellence in Financial Reporting	XIV
Organization of Local Government and Taxing Districts	
Introduction	XV
Form of Government	XV – XVI
Other Governmental Units	XVI – XVII
Maps	XVII – XVIII
Unigov Organizational Chart – Consolidated Government for Indianapolis – Marion County	XIX
City of Indianapolis Organizational Chart	XX
Schedule of Elected and Appointed Officials	XXI – XXIV
<b>II. FINANCIAL SECTION</b>	
INDEPENDENT AUDITOR’S REPORT	1 – 3
MANAGEMENT’S DISCUSSION AND ANALYSIS – REQUIRED SUPPLEMENTARY INFORMATION (UNAUDITED)	4 – 25
BASIC FINANCIAL STATEMENTS:	
Government-wide Financial Statements:	
Statement of Net Position	26 – 27
Statement of Activities	28
Fund Financial Statements:	
Balance Sheet – Governmental Funds	29
Reconciliation of the Balance Sheet for Governmental Funds to the Statement of Net Position	30
Statement of Revenues, Expenditures, and Changes in Fund Balances – Governmental Funds	31 – 32
Reconciliation of the Statement of Revenues, Expenditures, and Changes in Fund Balances of Governmental Funds to the Statement of Activities	33
Statement of Net Position – Proprietary Funds	34
Statement of Revenues, Expenses, and Changes in Fund Net Position – Proprietary Funds	35
Statement of Cash Flows – Proprietary Funds	36
Statement of Fiduciary Net Position – Fiduciary Funds	37
Statement of Changes in Fiduciary Net Position – Fiduciary Funds	38
Notes to Financial Statements	39 – 92

## TABLE OF CONTENTS (continued)

Page(s)

### REQUIRED SUPPLEMENTARY INFORMATION (UNAUDITED)

#### Budgetary Comparison Information:

Schedule of Revenues, Expenditures, and Changes in Fund Balance – Budget and Actual – Budgetary Basis – General Fund	93 – 94
Notes to Required Supplementary Information – Budgetary Comparison Schedule	95 – 96
Schedule of Changes in the City’s Net Pension Liability – Police Pre-1977 Plan	97 – 98
Schedule of Changes in the City’s Net Pension Liability – Firefighters’ Pre-1977 Plan	99 – 100
Schedule of Net Pension Liability and Related Ratios	101
Schedule of City’s Proportionate Share of Net Pension Liability	102 – 103
Schedule of City’s Pension Contributions	104 – 105
Schedule of the City’s Net OPEB Liability and Related Ratios	106
Schedule of the City’s OPEB Contributions	107

### COMBINING AND INDIVIDUAL FUND FINANCIAL STATEMENTS AND SCHEDULES – OTHER SUPPLEMENTARY INFORMATION

Combining Balance Sheet – Nonmajor Governmental Funds by Fund Type	108
Combining Statement of Revenues, Expenditures, and Changes in Fund Balances – Nonmajor Governmental Funds by Fund Type	109
Schedule of Subfund Assets, Liabilities, and Fund Balance – General Fund	110 – 111
Schedule of Subfund Revenues, Expenditures, and Changes in Fund Balance – General Fund	112 – 113
Schedule of Subfund Revenues, Expenditures, and Changes in Fund Balance – General Fund – Budget and Actual – Budgetary Basis	114 – 116
Schedule of Expenditures by Character – General Fund – Budget and Actual – Budgetary Basis	117 – 120
Combining Balance Sheet – Nonmajor Special Revenue Funds	121
Combining Statement of Revenues, Expenditures, and Changes in Fund Balances – Nonmajor Special Revenue Funds	122
Combining Schedule of Revenues, Expenditures, and Changes in Fund Balances – Special Revenue Funds – Budget and Actual – Budgetary Basis	123
Schedule of Expenditures by Character – Special Revenue Funds – Budget and Actual – Budgetary Basis	124 – 125
Combining Balance Sheet – Nonmajor Debt Service Funds	126
Combining Statement of Revenues, Expenditures, and Changes in Fund Balances – Nonmajor Debt Service Funds	127
Combining Schedule of Revenues, Expenditures, and Changes in Fund Balances – Debt Service Funds – Budget and Actual – Budgetary Basis	128 – 129
Schedule of Expenditures by Character – Debt Service Funds – Budget and Actual – Budgetary Basis	130
Combining Balance Sheet – Nonmajor Capital Projects Funds	131 – 133

## TABLE OF CONTENTS (continued)

Page(s)

---

Combining Statement of Revenues, Expenditures, and Changes in Fund Balances – Nonmajor Capital Projects Funds	134 – 136
Combining Schedule of Revenues, Expenditures, and Changes in Fund Balances – Annually Budgeted Capital Projects Funds – Budget and Actual – Budgetary Basis	137
Schedule of Expenditures by Character – Annually Budgeted Capital Projects Funds – Budget and Actual – Budgetary Basis	138
Combining Statement of Net Position – Internal Service Funds	139
Combining Statement of Revenues, Expenses, and Changes in Fund Net Position – Internal Service Funds	140
Combining Statement of Cash Flows – Internal Service Funds	141
Combining Statement of Pension Trust Funds Net Position – Fiduciary Funds	142
Combining Statement of Changes in Fiduciary Net Position – Fiduciary Funds – Police and Firefighters Pension Trust Funds	143
Schedule of Revenues and Expenditures – Fiduciary Funds – Police and Firefighters Pension Trust Funds – Budget and Actual – Budgetary Basis	144
Combining Statement of Fiduciary Net Position – Custodial Funds	145
Combining Statement of Changes in Fiduciary Net Position – Custodial Funds	146

### III. STATISTICAL SECTION (UNAUDITED)

Net Position by Component	1	147
Changes in Net Position	2	148
Program Revenues by Function/Program	3	149
Fund Balances - Governmental Funds	4	150
Changes in Fund Balances – Governmental Funds	5	151
Tax Revenues by Source – Governmental Funds	6	152
Assessed Value and Estimated Actual Value of Taxable Property	7	153
Direct and Overlapping Governments – Property Tax Rates	8	154
Principal Property Tax Payers	9	155
Property Tax Levies and Collections	10	156
Ratios of Outstanding Debt by Type	11	157
Ratios of Net General Bonded Debt Outstanding	12	158
Schedule of Direct and Overlapping Debt and Bonded Debt Limit	13	159 – 161

## TABLE OF CONTENTS (continued)

---

		<b>Page(s)</b>
Computation of Legal Debt Margin	14	162
Pledged Revenue Coverage	15	163
Demographic and Economic Statistics	16	164
Principal Employers	17	165
Full-Time Equivalent City Government Employees by Function/Program	18	166
Operating Indicators by Function/Program	19	167
Capital Asset Statistics by Function/Program	20	168



Introductory Section

# Introductory Section



October 17, 2023

To the Honorable Mayor Joe Hogsett, Members of the City-County Council, and Citizens of Indianapolis, Indiana:

I submit to you the Annual Comprehensive Financial Report (“ACFR”) of the City of Indianapolis (“City”) for the fiscal year ended December 31, 2022. The City is a component unit of the Consolidated City of Indianapolis – Marion County Reporting Entity. This report was prepared by the Office of Finance and Management (“OFM”). Responsibility for both the accuracy of the data presented and the completeness and fairness of the presentation, including all disclosures, rests with the Controller of the City of Indianapolis. The data, as presented, is accurate in all material respects. It is presented in a manner designed to set forth the financial position and results of operations of the City. Disclosures necessary to enable the reader to gain the maximum understanding of the City’s financial affairs are included.

The ACFR conforms to the standards for financial reporting of the Governmental Accounting Standards Board (“GASB”) and the Government Finance Officers Association of the United States and Canada (“GFOA”). There are three main sections to this report. The Introductory Section includes this letter, the Certificate of Achievement for Excellence in Financial Reporting, a description of the government and related taxing districts, a list of elected officials, and the City’s organizational charts. The Financial Section includes the independent auditor’s report, management’s discussion and analysis (“MD&A”), the basic financial statements for the City, and required and other supplementary information. The Statistical Section includes selected financial and demographic information presented on a multiyear basis. The MD&A can be found starting on page 4.

The City is required to undergo an annual single audit in conformity with the provisions of the *Title 2 U.S. Code of Federal Regulations (CFR) Part 200, Uniform Administrative Requirements, Cost Principles, and Audit Requirements for Federal Awards* (Uniform Guidance). Information related to the single audit, including the schedule of expenditures of federal awards, findings and recommendations, and auditor’s reports on internal control and compliance with applicable laws and regulations, is included in a separate report.

This report contains all funds of the City. The City operates under an elected Mayor and City-County Council (25 members) form of government. The City provides services in public safety, public works, health and welfare, cultural and recreation, urban redevelopment and housing, and economic development.

## ECONOMIC CONDITION AND OUTLOOK

### Regional Economy

Indianapolis has a growing and diversified economy with employment and per capita income rates that historically have outperformed both state and national averages. The Indianapolis Chamber of Commerce reported 64 successful relocation and expansion projects in 2022, leading to 3,982 new jobs with an average wage of \$37.81 an hour and 4,542 retained jobs at an average of \$38.67 per hour with over \$1.1 billion in capital investment.<sup>1</sup> Three of Indiana's Fortune 500 companies are located in Indianapolis and the City is home to many of the State's largest public companies, including: Elevance Health (Anthem Inc.), Eli Lilly and Co., Simon Property Group Inc., Calumet Specialty Products Partners LP, Allison Transmission Holdings Inc., and Duke Realty Corp. The City is also a logistics center that features the world's second-largest FedEx Corp hub, United Parcel Service Inc., Schneider National Inc., and others.<sup>2</sup>

Known as the *Crossroads of America*, Indianapolis is connected to the rest of the nation by four major interstate highways, making it a prime location for distribution and shipping. Indianapolis is also home to the Indianapolis International Airport (IND), which averaged 117 daily flights to 45 nonstop destinations in 2022. More than 8.7 million passengers flew through IND in 2022, an increase in overall passenger traffic by 21.1% percent compared to 2021.<sup>3</sup> In addition to providing a workforce of 22,500 jobs, IND is home to the world's second largest FedEx operation and the nation's eighth-largest cargo facility.<sup>4</sup> IND recorded 1.25 million tons of total cargo in 2022 and 6.01 million tons of landed weight.<sup>5</sup> In 2018, FedEx Corp announced a major expansion of its IND facility, and now has 1.9 million square feet with 80 gates, doubling capacity from two sorts to four sorts per day, with employment increasing to between 4,100 and 4,600 (subject to peak periods). FedEx Corp extended its land lease through 2053, with options for two 10-year renewals<sup>6</sup>. In 2021, FedEx funded \$252 million in improvements at its sorting facility and expanded capacity.<sup>7</sup> In 2021 FedEx processed the highest volume of cargo in their history at IND.<sup>8</sup> In 2023, IND was voted Best Airport in North America by Airports Council International for the eleventh consecutive year<sup>9</sup> and was listed among the Top 10 Best Domestic Airports by Travel+Leisure.<sup>10</sup>

The City is home to 25 institutions of higher learning with over 141,000 students enrolled in the 2021-2022 academic year.<sup>11</sup> Seventeen colleges within Marion County offer Associate's Degrees and 22 Universities offer Bachelor's Degrees or higher, supporting the high educational attainment rate of 32.8% for Indianapolis' residents with bachelor's degree or higher.<sup>12</sup> These include Indiana University-Purdue University Indianapolis (IUPUI), Butler University, University of Indianapolis, Marian University, Ivy Tech Community College and

---

<sup>1</sup> Data retrieved from: <https://indychamber.com/news/develop-indy-year-end-review-by-the-numbers/>

<sup>2</sup> The Indianapolis Chamber of Commerce. "Indianapolis Region Largest Logistics Companies." <https://indychamber.com/economic-development/indy-partnership/>.

<sup>3</sup> Indianapolis Airport Authority, Annual Report, 2022

<sup>4</sup> [https://www.faa.gov/airports/planning\\_capacity/passenger\\_allcargo\\_stats/passenger/cy21\\_cargo\\_airports](https://www.faa.gov/airports/planning_capacity/passenger_allcargo_stats/passenger/cy21_cargo_airports)

<sup>5</sup> Indianapolis Airport Authority. "December 2022 IND Airline Activity Report"

<sup>6</sup> [Indianapolis Airport Authority Staff update](#)

<sup>7</sup> Ibid.

<sup>8</sup> IND "Indy Airport Ahead of Other Airports in Passenger Traffic Recovery" <https://www.ind.com/about/media/media-releases/indy-airport-ahead-of-other-airports-in-passenger-traffic-recovery>

<sup>9</sup> Airports Council International. "ACI Reveals World's Best Airports for Customer Experience" <https://aci.aero/programs-and-services/asq/asq-awards-and-recognition/>

<sup>10</sup> Travel + Leisure. "The Top Ten Domestic Airports" <https://www.travelandleisure.com/worlds-best/airports-domestic>

<sup>11</sup> Marion County Post-Secondary Education Student Enrollment: <https://nces.ed.gov/collegenavigator/?s=IN&of=1&od=0&pg=5>

<sup>12</sup> U.S. Census Bureau, 2021 ACS 1-Year Estimates and The Indy Partnership website: <https://properties.zoomprospector.com/indypartnership/community/Marion-County-IN/18097>.

others.<sup>13</sup> The Indianapolis area is served by 246 K-12 schools and 11 public school districts, with a population of 159,000 students distributed among all public and private schools.<sup>14</sup>

Indianapolis' Healthcare sector has expanded in the past decade and continues to grow. Eskenazi Hospital, Indiana's largest public hospital, was completed in December 2013. The \$750 million state-of-the-art facility houses Level I Trauma and Burn Units, psychiatric, long-term, outpatient, and other care centers. Indiana University Health ("IU Health") continues to expand in the City; previously, IU Health announced a \$1.6 billion expansion and in 2022 increased the expansion with an additional investment of \$1.08 billion citing increased patient demand. In 2023, IU Health announced an updated price tag of the expansion totaling \$4.3 billion. The three patient towers will now be 16-story towers up from the previously planned 12-story towers and patient rooms will be increased by 29% to 864 rooms from 672 rooms, for a total space of over 2 million square feet.<sup>15</sup> The project also includes a new five-story office building and parking garage. The complex will consolidate the IU Health Methodist and IU Health University Hospitals into a 44-acre, integrated "green" campus and construction is underway.<sup>16</sup> IU School of Medicine broke ground in 2022 on a new \$230 million medical education and research center.<sup>17</sup> Riley Hospital completed a \$142 million expansion of a new maternity and newborn health center in 2021, serving as the largest NICU in Indiana and among the largest in the country.<sup>18</sup>

In addition to the healthcare sector, Indianapolis employs nearly 25,000 people in the life sciences industry, with companies such as Corteva Agriscience (DowDuPont (DWDP)), Eli Lilly and Co. (LLY), and Elevance Health (Anthem Inc. (ELV)), headquartered in Indianapolis and Roche Diagnostics (RHHBY), Express Scripts (ESRX), and Covance Inc. (CVD) operating in the City. A report from the Indiana Business Research Center and BioCrossroads notes that Indiana is the third highest life science-exporting state in the United States. Indiana exported \$13 billion worth of life science products in 2022, an estimated \$77 billion in State economic impact.<sup>19</sup> In 2022, 37 Indiana Life Science companies raised more than \$620 million in venture capital funding, an increase of \$200 million from 2021.<sup>20</sup> In November 2019, Lilly announced \$400 million in new investments at the Lilly Technology Center in three phases to increase capacity for new medicines and future diabetes therapies, resulting in over 100 new, highly skilled jobs.<sup>21</sup> The company has invested roughly \$4.5 billion<sup>22</sup> in its Indianapolis facilities since 2012 and has over 2.7 million square feet of laboratory space.<sup>23</sup> Lilly continues to invest in the Indianapolis area and in 2022 announced a \$3.7 billion research and manufacturing facility in neighboring Boone County.<sup>24</sup>

Indianapolis continues to be a major sports and convention destination. Indianapolis Motor Speedway is home to the Indy 500 race, Lucas Oil Stadium is home to the Indianapolis Colts, hosting Super Bowl XLVI and multiple NCAA Men's Final Four tournaments and Big Ten Football Championships. Indianapolis annually hosts the Big Ten Football championship game and has won the bid for several large events

---

<sup>13</sup> National Center for Education Statistics, Indiana <https://nces.ed.gov/collegenavigator/?s=IN&zc=46204&zd=15&of=3>

<sup>14</sup> Public School Review "Top 10 Best Marion County Public Schools (2022-23)"

<sup>15</sup> *Indianapolis Business Journal*, "IU Health expands plan for downtown hospital, pushing price tag to \$4.3B" <https://www.ijb.com/articles/new-price-tag-of-iu-healths-downtown-hospital-4-3-billion>

<sup>16</sup> *Inside Indiana Business*, "IU Health reevaluating scope of \$2.68B downtown campus" <https://www.insideindianabusiness.com/articles/iu-health-reevaluating-scope-of-2-68b-downtown-hospital-campus>

<sup>17</sup> *Indianapolis Business Journal*, "IU School of Medicine to break ground on new, \$230M home" <https://www.ijb.com/articles/iu-school-of-medicine-to-break-ground-on-new-230m-home>

<sup>18</sup> *Indianapolis Business Journal*, Riley Hospital's new maternity tower strives for a smooth delivery <https://www.ijb.com/articles/riley-hospitals-new-maternity-tower-strives-for-a-smooth-delivery>

<sup>19</sup> *Inside Indiana Business* "Record year of life sciences exports" <https://www.insideindianabusiness.com/articles/a-record-year-of-life-sciences-exports>

<sup>20</sup> BioCrossroads, Indiana's Life Sciences Industry [https://www.cicpindiana.com/wp-content/uploads/2023/03/BIOX\\_2022-Annual-Report\\_WEB-FINAL.pdf](https://www.cicpindiana.com/wp-content/uploads/2023/03/BIOX_2022-Annual-Report_WEB-FINAL.pdf)

<sup>21</sup> *WFYI Indianapolis*, "Eli Lilly To Invest \$400 Million Upgrading, Expanding Its Indiana Manufacturing", November 20, 2019 <https://www.wfyi.org/news/articles/eli-lilly-to-invest-400-million-upgrading-expanding-its-indiana-manufacturing>

<sup>22</sup> *IndyStar* "Eli Lilly seeks \$24 million in tax abatements for renovations and expansion" <https://www.indystar.com/story/news/local/marion-county/2020/07/21/eli-lilly-seeks-roughly-24-million-tax-abatements-over-decade/5442778002/>

<sup>23</sup> *IndyStar* "Lilly unveils new \$75M research building in Indianapolis" <https://www.ijb.com/articles/69436-lilly-unveils-new-75m-research-building-in-indianapolis>

<sup>24</sup> *IndyStar* "Lilly add another \$1.6B, 200 jobs to Boone County project" <https://www.indystar.com/story/news/local/indianapolis/2023/04/17/lilly-adds-1-6b-200-jobs-to-boone-county-project/70122119007/>

including: the 2021 NBA All-Star Weekend; the Women’s Big Ten Basketball Tournament; the NCAA Men’s 2021 Final Four; and the NCAA College 2022 Football National Championship. Due to the COVID-19 Pandemic, the City hosted the 2021 Big Ten Men and Women’s Basketball Tournament, the entire 64-game NCAA Men’s Basketball Tournament and will host the 2024 NBA All-Star Weekend that was originally scheduled to be hosted in Indianapolis in 2021. After a hiatus due to the pandemic, the NFL Combine returned to Indianapolis in 2022 and will stay through 2024. Indianapolis hosted the NBA2K League in 2022, the first year the League operated outside of New York City. The 2024 USA Swimming Olympic Team Trial will be at Lucas Oil Stadium. Additionally, Indianapolis will host the NCAA Basketball Final Four Men’s in 2026 and 2029 and the NCAA Basketball Final Four Women’s in 2028. Gainbridge Fieldhouse is home to the Indiana Pacers and the Indiana Fever, which is currently undergoing a \$360 million renovation and expansion project with interior renovation completed in 2022 and outdoor expansion expected to be completed by summer 2023. Victory Field is home to the Indianapolis Indians, Pittsburgh’s Triple-A affiliate. All three major sports facilities are within walking distance or connected by the skywalk system to the Indiana Convention Center.

The Indiana Convention Center is the 24th largest convention center by exhibition size in the U.S. and is poised for another major expansion. The 300,000 square-foot expansion includes a 50,000 square-foot ballroom and new pedestrian skybridge and is scheduled to open in 2026. Indianapolis hosted 27 million visitors in 2022. Hotel performance in Marion County finished strong in 2022, with hotel revenue at 105.6% and hotel occupancy at 93.8% of record-setting 2019 levels. The top annual conventions and events include Gen Con (70,000 visitors), National FFA Convention (64,000 visitors), Big Ten Championship (70,000 visitors), and the Indy 500 (up to 300,000 attending). For 2022, Visit Indy reported \$4.9 billion in economic impact from convention tourism, making a full recovery to pre-pandemic levels. Indianapolis is slated to host 518 events in 2023.

Key cultural destinations include the Indianapolis Zoo, the Indiana State Museum, the NCAA Headquarters and Hall of Champions, the Eiteljorg Museum of American Indian and Western Art, the Children’s Museum of Indianapolis, Newfields: A Place for Nature & The Arts (previously known as the Indianapolis Museum of Art) and seven war memorials and monuments honoring our nation’s fallen service members. The Children’s Museum of Indianapolis, the largest of its kind,<sup>25</sup> was named USA Today’s best Children’s Museum in the U.S in 2023.<sup>26</sup> The City’s expanding culinary scene has been recognized by Condé Nast Traveler as “the most underrated food city in the U.S.” Forbes named Indianapolis one of the “25 Best Places to Visit in 2020”<sup>27</sup> and Travel and Leisure ranked Indianapolis #19 “50 Best Places to Travel in 2021”<sup>28</sup> citing the newly opened Bottletworks development as a key destination to visit. In 2022, BestLife named Newfields’ 150-acre campus and gardens to the top of their “The 10 Best U.S. Gardens to Stroll Through – Even in Cold Weather.”<sup>29</sup> Food & Wine named Indianapolis as one of “America’s Next Great Food Cities” in 2022, noting the City’s “real diversity of cuisines; an abundance of affordable, quality dining options; and a vibrant mix of personalities championing food access for all.”<sup>30</sup>

---

<sup>25</sup> Wikipedia “The Children’s Museum of Indianapolis” [https://en.wikipedia.org/wiki/The\\_Children%27s\\_Museum\\_of\\_Indianapolis](https://en.wikipedia.org/wiki/The_Children%27s_Museum_of_Indianapolis)

<sup>26</sup> USA Today “Best Children’s Museum (2023)” <https://www.10best.com/awards/travel/best-childrens-museum-2023/>

<sup>27</sup> Forbes “Best Places to Travel in 2020” <https://www.forbes.com/sites/laurabegleybloom/2019/12/19/best-places-travel-us-2020/?sh=55d493f84898>

<sup>28</sup> Travel and Leisure “21 Best Places to Travel in 2021” <https://www.travelandleisure.com/trip-ideas/best-places-to-travel-in-2021>

<sup>29</sup> BestLife “The 10 Best U.S. Gardens To Stroll Through—Even in Cold Weather” <https://bestlifeonline.com/best-garden-in-us-news/>

<sup>30</sup> Food & Wine “These Are America’s Next Great Food Cities” <https://www.foodandwine.com/travel/best-food-cities>

## **Economic Development**

2022 continued to be a strong year for Indianapolis economic development with high job growth in emerging sectors like radiopharmaceuticals, advanced manufacturing, innovative engineering, and more. These year-end numbers indicate Indianapolis's economic development investment from growing industries, creating an environment that attracts employers, drives placemaking, and creates an opportunity for breakthrough innovations. 2022 was a historic year for community and economic development across Indianapolis neighborhoods, from large-scale projects to growing the stock of affordable housing, to the release of a historic number of redevelopment opportunities—Indianapolis is creating a better City for residents and businesses.

The City, in partnership with Develop Indy, operated for the third year under an “Inclusive Incentives” policy to advance job opportunities for Indianapolis residents and remove barriers to employment that prevent individuals from attaining and retaining good-paying jobs. The City's tax abatement policy continues to target industries that support the growth of jobs paying more than \$18 per hour and providing opportunities for both skilled and sub-baccalaureate workers. Businesses receiving incentives must also invest in social supports for their workforce, including transit, childcare, and training. These changes are supported by data-driven research from the City and Indy Chamber's engagement with the Brookings Institution, and are intended to align the City's tax incentives with areas of growth and opportunity in the City's economy.

Since 2016, the City has favored the use of developer-backed bonds as a primary way to incentivize private mixed-use real estate economic development projects, a policy that limits the City's exposure by only pledging a portion of Tax Increment Finance revenues from the project toward debt, with the developer backing any shortfall. Other considerations for incentivization include transit-oriented development, the creation of affordable and workforce housing, and activation of vacant or under-performing parcels.

Develop Indy is also engaged in business and community development efforts beyond traditional corporate attraction. With the tight labor market, Develop Indy's Business Retention and Expansion manager worked with community and re-entry organizations such as Program of All-Inclusive Care for the Elderly (“PACE”), Indiana Department of Correction (“IDOC”), Helping Veterans and Families (“HVAF”), and the Indianapolis Urban League to help refer 500+ individuals into accessible jobs. As part of the Indy Chamber and a partner of the City, Develop Indy also continues to serve a customer service function to support the existing business community, while welcoming new businesses to the City.

## **2022 Job Commitments and Investments**

In support of the primary economic development goals for the City, 8,524 job commitments (3,982 new jobs/4,542 current and retained jobs) and over \$1.1 billion in capital investment from 64 successful relocation and expansion projects were announced in 2022. The average wage for retained jobs was \$38.67 per hour and the average wage for new jobs was \$37.81 per hour. These successes were realized due to the partnership between the Mayor's Office and the Indy Chamber. The commitment from companies to add and retain over 8,524 jobs and invest more than \$1.1 billion in Indianapolis is a testament to the fact that the City continues to be a great place to live and do business. Companies benefit from Indianapolis' stable, affordable and pro-growth economic environment, skilled workforce, central location, and overall low cost of doing business. Of the \$1.1 billion in investment this year, roughly 50% was through real estate development supporting businesses, residents, and tourism.

## **2022 Notable Projects**

**Combined Curiosity LLC:** Indianapolis-based Combined Curiosity LLC announced plans to create more than 300 jobs by the end of 2026 for its growing consumer-centric platform. The company's technology helps connect people with educational and recreational online courses and hobbies.

**UKG Inc:** Human-resources technology company UKG Inc. already has more than 300 employees at its downtown Indianapolis office and plans to create up to an additional 200 new, high-wage jobs over the next three years. UKG offers a software platform for handling payroll, timekeeping, employee scheduling and other human resources functions. The company has dual headquarters in Lowell, Massachusetts, and Weston, Florida, and employs nearly 15,000 people worldwide.

**Tek Experts:** Tek Experts, the global information technology and business support services company, is opening its second United States location in Indianapolis, capitalizing on the tremendous pool of technical talent available in the region. The company plans to create up to 500 jobs by the end of 2027 in central Indiana as part of the launch.

**Rolls-Royce:** In Indianapolis, Rolls-Royce's facilities develop, test and manufacture aircraft engines for use in civilian and military applications. Since 2015, Rolls-Royce has invested over \$600 million to modernize its facilities, keeping up to date with today's manufacturing standards. As the company continues optimizing efficiency at their main Indianapolis campus, Rolls-Royce will be investing \$63.5 million over the next year to renovate its testing campus. This construction activity will be complemented by a \$154.1 million investment in machinery and equipment on site, through 2026.

**RayzeBio:** A San Diego-based radiopharmaceutical company focused on the development of cancer therapies targeting solid tumors. The company is opening its first facility in Indianapolis, making a \$45 million investment for the redevelopment and equipping of a 63,000 square foot warehouse into a fully functional GMP Radiopharmaceutical research and development facility. RayzeBio will also be creating up to 70 new jobs by the end of 2026.

**Indy Innovation Apartments:** Browning Investments LLC in partnership with Barrett & Stokely Inc. broke ground this year on Indy Innovation Apartments, a \$50 million multifamily project with 279-units, contributing to the momentum of 16Tech, a 50-acre technology-focused development located northwest of downtown.

**1820 Ventures - Cole Motor Redevelopment:** The City-County Council authorized up to \$15.5 million in Economic Development Tax Increment Revenue Bonds to 1820 Ventures, LLC, for the redevelopment of the former Jail II building and Arrestee Processing Center, located at approximately 730 E. Washington St. and 752 E. Market St. 1820 Ventures plans to spend about \$120 million to develop the project. Current plans call for street-level retail on Washington and Market streets, an education component, a co-working space and a second location for longtime Broad Ripple music venue The Vogue. The 180,000-square-foot Jail II building will be converted into 140 market-rate and affordable one-, two- and three-bedroom units—along with a rooftop deck and amenities including a dog park and fitness center. Construction at the site is set to begin in 2023.

**Lauth – Thunderbird Commerce Center:** Lauth Group Inc is developing a \$175 million multitenant industrial park at the former Ford Visteon plant on the east side. The 148-acre site that Lauth has branded Thunderbird Commerce Center is expected to be a 2,000,000-square-foot modern industrial park. Two structures are already in the works for Thunderbird: the first, a build-to suit building on 44 acres in the southwest corner of the property, and another 608,000-square-foot warehouse set to be completed by the end of 2023. Monarch Distributing, LLC, one of the tenants at this development is committing to retaining 500 jobs.



**Direct Connect Logistix Inc.:** The Indianapolis-based logistics company, announced plans to move its headquarters to the Circle Centre Mall taking over 52,000 square feet and plans to add an additional 150 employees by the end of 2023. The company currently has approximately 250 employees based in Indianapolis.

**Spot Freight Inc.:** National logistics company, announced in late 2022 the opening of its second Indianapolis office and plans to grow its office staff from 350 to 600. The company will have two locations in Downtown's Mile Square, more than doubling their downtown office space.

**Historic Stutz building** – A former auto factory – is undergoing an \$80 million renovation to update the over 400,000 square foot buildings. The property will continue to be home to offices, artist studios, lab space and more. The over 100-year-old property will see 12 new restaurants and shops, a Stutz car museum, event space, health and wellness offerings, updated alleyways and public spaces.

**Bottleworks District:** The \$300 million Bottleworks District, as featured by TIME's "World's Greatest Places 2021," opened Phase I in 2020 featuring a food hall, hotel, movie theatre, retail space and office space. Phase II is underway and set for completion in 2025, including 182,000 square feet of office space and 38,000 square feet of additional retail space. Apartment Therapy has highlighted the Art Deco architecture preserved from the former Coca-Cola bottling plant and incorporated throughout the development.

**16 Tech:** a 50-acre innovation campus located on the northwest side of downtown, is home to the Indiana Biosciences Research Institute. The first project phase, which opened in 2020, included: 1) a 120,000 square foot Innovation Building I; 2) Hq0, a 105,000 square foot coworking, incubator and makerspace; and 3) the Artisan Marketplace, a 40,000 square foot building with over 20 food vendors. The City invested \$55.8 million in the innovation district's public infrastructure through tax increment-backed bonds issued in 2019 and 2022. A 1,000 -space parking garage opened in 2022, and the groundbreaking for a new, architecturally significant bridge over Fall Creek took place in March 2023. Construction of a 279-unit multi-family residential project is expected to begin this year. Additional office space, lab space and a central public green are planned for future phases.

**Elanco Animal Health Inc.:** In April 2023, broke ground on a \$100 million new global headquarters at the former General Motors stamping plant site west of downtown. The state-of-the-art facility is designed to incorporate post-pandemic work concepts as well as sustainability, on a 45-acre campus that will relocate 1,623 jobs to the downtown area and create up to 573 high-wage jobs. The City issued Consolidated TIF bonds in 2022 to contribute \$64 million to the new campus and its infrastructure and an additional \$51 million for a new bridge across the White River and additional public infrastructure and connectivity. The headquarters is estimated to be completed in February 2025.

## **LONG-TERM FINANCIAL PLANNING**

The Office of Finance and Management (“OFM”) is responsible for financial planning for the City and Marion County. OFM is also responsible for the annual budgets of all agencies, both the development and the execution. OFM employs a sophisticated modeling system to estimate property tax revenues for both the current budget year and future years. With this tool, the City has more ability to model the effects of property tax caps and tax increment capture than any other municipality in the State of Indiana.

### **Property Tax**

The City collected \$373 million in net property tax revenue in 2022, including TIF. The City expects to collect \$399 million in net property tax revenue in 2023. The Circuit breaker impact is estimated to be \$35 million in 2023, approximately 12% of certified property tax levies. This represents a decrease from the \$41 million loss in property tax revenue experienced in 2022.

This revenue loss is due to House Enrolled Act 1001, enacted by the Indiana General Assembly in 2008, which limits the property tax liability of each parcel. The law set a three (3) tiered cap on property tax liability covering the five (5) property classes – homesteads, other residential, agricultural, commercial, and industrial. These tiers are structured as follows:

Maximum liability equals 1% of parcel Gross Assessed Value (“GAV”) – homesteads;

Maximum liability equals 2% of parcel GAV – agricultural and other residential;

Maximum liability equals 3% of parcel GAV – commercial and industrial.

### **Local Income Tax (“LIT”)**

LIT is an income tax based revenue stream with a flat rate structure, imposed on state adjusted gross income of County taxpayers. The tax rate is imposed based on the residency of the taxpayer, not the county of employment. The tax is authorized by statute and is applicable to all Indiana municipalities. The tax does not sunset. The LIT rate is established by the Marion County Income Tax Council. In Indiana, the State Department of Revenue serves as the collection agent for all County income taxes. Thus, each county relies on annual distributions of county income tax revenues from the State. The State Budget Agency (“SBA”), in collaboration with the State Department of Revenue and the Department of Local Government Finance, administers these annual distributions. These annual distributions are shared among the county government, all townships, and the municipalities located within the county, including the City. For Marion County, OFM is responsible for calculating the allocation of county income tax revenues to all eligible entities pursuant to a Marion County specific formula found in State statute. OFM works very closely with the State Budget Agency to track and forecast income tax collections and annual certified distributions.

The certified distribution is a guaranteed amount of LIT revenue remitted by the State Auditor to the County Treasurer monthly in 1/12th increments based on total income tax returns processed from July-December of the prior fiscal year and January-June of the current fiscal year. For 2022, total LIT revenue distributed to the City attributed to the annual certified distribution was \$278 million, which includes the three components of the income taxes, the total rate in 2022 was 1.7603%: County Option Income Tax (“COIT”) (1.0300%), Public Safety Income Tax (“PSIT”) (0.5000%), and the Local Option Income Tax (“LOIT”) Levy Freeze (0.2303%). In 2021, total City income taxes distributed were \$305 million. The \$27 million decrease from 2021 is mainly attributed to \$12 million being allocated to the County, as part

of a reorganization of the Metropolitan Emergency Services Agency, which was effective January 1, 2022. The remaining \$15 million decrease is attributable to a discretionary decision made by OFM to allocate more to the County, along with an impact in decreased collections as a direct result of the COVID-19 pandemic. The effects of economic events on income tax collections are not revealed in annual distributions to counties until two years later, due to the fact that certified distributions are based on income earned two years in arrears. Per statute, when the balance exceeds 15% of the certified distribution, supplemental distributions are released based upon the balance in the Trust Account reported two years prior to the certified distribution year. Every April, the SBA reviews the amount each local entity has generated in the State-held Trust Fund and, if applicable, distributes any excess in May. In May 2022, the City received a supplemental amount of \$20 million, bringing total income taxes received in 2022 to \$298 million.

### **5 Year Forecasting**

As part of the long-term financial planning for the City, the City Controller has developed a 5-year financial plan focusing on available funds over the next 5 years. The 5-year financial plan will provide projections of major revenue sources such as property taxes, income taxes, other major miscellaneous revenue sources, and the impact of the circuit breaker. In addition, the plan makes various assumptions for major expenditures such as personnel costs, contractual obligations, and capital needs. The 5-year financial plan will be reviewed and updated quarterly to monitor and respond to changes in fund balances, revenues, and expenditures.

## **RELEVANT FINANCIAL POLICIES**

### **Internal Control Structure**

Management of the City is responsible to establish and maintain an internal control structure that ensures the assets of the government are protected from loss, theft, or misuse and ensures that adequate accounting data are compiled to allow for the preparation of financial statements in conformity with accounting principles generally accepted in the United States of America. The internal control structure is designed to provide reasonable, but not absolute, assurance that these objectives are met. The concept of reasonable assurance recognizes that: (1) the cost of a control should not exceed the benefits likely to be derived; and (2) the valuation of costs and benefits requires estimates and judgments by management.

### **Budgetary Control**

Budgetary control is maintained for certain funds, at the object level of expenditure by the encumbrance of purchase orders against available appropriations. The City uses the Government Accounting Standards Board (“GASB”) expenditure terminology (object) for financial reporting purposes and State of Indiana expenditure terminology (character) for internal accounting purposes. Capital projects reimbursable by grant revenues are encumbered for the total amount of the estimated project cost. Outstanding encumbrances to be financed from future revenues, other than approved grant revenues and certain Consolidated County budgetary account reimbursements, are recorded in their entirety as assigned fund balances.

## MAJOR INITIATIVES

The City continues to identify ways to create efficiencies and improve delivery of services. OFM works closely with City departments and City administration to create opportunities to reduce expenditures and identify new revenue sources, providing the ability to increase investments across Indianapolis-Marion County to benefit residents and taxpayers. As a result of strong fiscal policy and management, the City has received multiple credit rating upgrades since 2017, maintaining a AAA credit rating by showing solid cash reserves, including the Fiscal Stability fund, where we continue to keep a targeted unassigned fund balance of at least \$80 million. The Fiscal Stability Fund was established by law and has the primary purpose of supporting a solid credit rating for the City.

The City's fund balance policy also establishes a minimum level of funding reserves and the requirement that, if used, the City must establish a plan to replenish reserves in the following year. In addition, legislation passed by the Indiana General Assembly Senate Enrolled Act 621-2013, provided that budgets may be allocated on a semiannual basis as determined by the Controller. In addition, if revenues and fund balance are less than budgeted expenditures, the Controller can reduce agency budgets to create a funded budget. Under SEA 621, the City may impose management reserves, which places a percentage of each department's budget into reserve and does not allow for expenditure unless the Controller believes the appropriation is fully supported by a combination of current revenues and existing fund balance. This statute gives OFM and the Controller the authority needed to maintain strong financial management practices and policies, providing for a strong framework for solid fiscal operations.

Despite the effects of the COVID-19 pandemic, the 2022 budget was a structurally balanced budget. The adopted 2022 budget increases investments across the City, maintains positive fund balances, protects the Fiscal Stability fund, and continues to operate an efficient City government. Fiscal challenges brought on by the pandemic required strategic investment and conservative revenue forecasting in 2022. The 2022 Budget is guided by the priorities of Mayor Joe Hogsett and the City-County Council. It keeps Indianapolis on a path of strong fiscal stability while making strategic investments. Most notably, the 2022 budget does not diminish the level of government service, but includes strategic investments in public health and safety, infrastructure, criminal justice reform, and neighborhood development. The 2022 budget funds the following initiatives:

- Investment in community programs that helps reduce the prevalence of homelessness, treat addiction, and address mental health challenges
- New and existing violence reduction and intervention initiatives and grants managed by the Office of Public Health and Safety (“OPHS”) including Community Crime Prevention Grants, as well as funding for the Witness Protection Program and the Group Violence Intervention program
- Honors all commitments made by the City with collective bargaining groups, including funding for 1,743 police officers and 1,220 firefighters
- Annual commitment of the four-year infrastructure plan to invest more than \$163 million in roads, bridges, and greenways
- \$107 million for storm water systems across Indianapolis' neighborhoods
- Completion of DPW second shift to increase capacity and reduce overtime spending
- Programming that supports and connects individuals experiencing homelessness to permanent supportive housing
- Scholarships for Indianapolis residents pursuing a post-secondary degree or credential through the Indy Achieves program
- \$1.1 million for direct grants to Indianapolis arts organizations
- 290 patrol vehicles
- \$1 million for IFD apparatuses

- \$250 thousand increase for the Parks Department to respond to critical infrastructure needs for a total of \$1.25 million
- \$1.25 million for new solid waste trucks
- Increased funding for Department of Metropolitan Development property acquisition for economic development initiatives

Although the 2022 budget was largely an operational budget in nature, it marked the beginning of a \$190 million initiative to upgrade critical government facilities and enhance service delivery to residents. This project, named Circle City Forward, demonstrates the Hogsett administration’s commitment to public investment in neighborhoods and jump-starting the economy.

The payoff of existing pension bonds, which had approximately \$9.5 million in annual debt service payments have provided a financing mechanism to allow these projects to move forward, by offsetting the expiring pension levy with a mix of additional general obligation debt projects and by levying additional county cumulative funds. Projects were bonded for as their initial project scoping and design were complete and debt was issued in 2021, 2022, and anticipated in 2023 and 2024. The City has received approval for debt financing for the following projects:

- Frederick Douglass Park and Family Center facility
- Improvements to Dr. Martin Luther King Jr. Park
- Upgrades to Riverside Park, Krannert Park and Grassy Creek Park
- Fire station replacement of Station 32 and 20
- New Animal Care facility
- New solid waste garage
- Enhancement to City Market infrastructure

In addition to the \$168 million in CARES Act funding received in 2020 to address the impacts of COVID, during May 2021, the City received additional stimulus in the amount of \$210 million via the Coronavirus State and Local Fiscal Recovery Funds. This was authorized by the American Rescue Plan Act, which provided \$350 billion in emergency funding for eligible state, local, territorial, and tribal governments. The \$210 million represents 50% of the City’s entire \$419 million allocation, the remaining 50% was received in June of 2022. The U.S. Treasury released the Interim Final Rule for the program that describes eligible uses for funding, which include responding to acute pandemic-response needs, filling revenue shortfalls, and supporting the communities and populations hardest-hit by the COVID-19 crisis. The program can incur expenses between March 1, 2021 through December 31, 2024. These funds will help extend critical resources for our community, which will help turn the tide on the pandemic, address its economic fallout and lay the foundation for a strong and equitable recovery. We look forward to expanding our relief capacity through the distribution of American Rescue Plan funding over the coming years.

The adopted 2023 budget continues increases in investments across Indianapolis-Marion County to benefit residents and taxpayers, maintains positive fund balances, protects the Fiscal Stability fund, and continues to operate an efficient City-County government – without raising taxes or selling off assets. As a result of strong revenue growth, this budget prioritizes critical investments in public safety and infrastructure along with improvements in general government services. The 2023 budget funds the following initiatives:

- \$5 million for the Crime Guns Task Force, a Central Indiana partnership staffed by more than 35 officers, detectives, agents, analysts, and prosecutors focused on reducing gun violence by removing illegally possessed guns from the community

- Investment in community programs that help reduce the prevalence of homelessness, treat addiction, and address mental health challenges
- \$2 million to hire the City's first team of mental health professionals to respond when residents experience mental health crises
- New and existing violence reduction and intervention initiatives managed by the Office of Public Health and Safety (OPHS), including the Witness Protection Program and the Group Violence Intervention program
- \$250 thousand in continued funding for the Tenant Legal Assistance Project and the Eviction Avoidance Project with Indiana Legal Services
- Funding for 1,743 police officers and 1,220 firefighters
- \$287.7 million for roads, bridges, and greenway improvements across Indianapolis neighborhoods in 2023
- \$156.7 million for storm water systems improvements across Indianapolis neighborhoods in 2023
- An additional \$500 thousand for the Indy Achieves program to provide scholarships for Indianapolis residents pursuing a post-secondary degree or credential
- \$1.3 million for direct grants to more than 100 Indianapolis arts organizations including increased funding access for People of Color Conference (“PoCC”) institutions
- \$1.2 million for IMPD patrol vehicles and \$2 million for IFD apparatuses
- \$575 thousand in additional funding for Public Works equipment needs, specifically for the solid waste, grounds maintenance, and fleet services programs

The City is continuing to deploy Coronavirus State and Local Fiscal Recovery funds made available through the American Rescue Plan Act. The City and County’s direct allocation is \$419 million, which has all been received. The Administration, in conjunction with the Council, has allocated funds to address important priorities including violence reduction, affordable housing, hunger, and homelessness, as well as economic and community development initiatives.

The 2023 budget supports vital services that make the Consolidated City of Indianapolis, Marion County a great city. This budget demonstrates the Administration’s commitment to fiscal stability and long-term financial planning, while also making substantial investments in public safety, infrastructure, and other forward-looking projects that will shape Indianapolis’ future.

## OTHER INFORMATION

### Audit Committee

The Consolidated City-County’s Audit Committee was formalized by City-County Council ordinance to provide an independent review body for the audit activities of the City. As of December 31, 2022, the Audit Committee members were:

Mr. David Reynolds, <i>Chairperson</i>	Policy Analytics, Senior Vice President
Ms. Crystal Allen	CEO and VP Tax and Accounting Services-A Total Solution
Mr. Michael Claytor	Retired Accountant, Active Attorney
Mr. Ryan Mann	Mayor’s Office – Special Counsel to the Mayor
Mr. Daniel Boots	City-County Councilor, City of Indianapolis – Marion County
Ms. Tanya Ndiaye	The Organizer, Accountant
Mr. Michael-Paul Hart	City-County Councilor, City of Indianapolis – Marion County

### Certificate of Achievement

The GFOA awarded a Certificate of Achievement for Excellence in Financial Reporting to the City of Indianapolis for its Annual Comprehensive Financial Report for the fiscal year ended December 31, 2021. In order to be awarded a Certificate of Achievement, a governmental unit must publish an easily readable and efficiently organized annual comprehensive financial report, whose contents conform to program standards. Such reports must satisfy both U.S. generally accepted accounting principles and applicable legal requirements.

A Certificate of Achievement is valid for a period of one year. We believe our current report continues to conform to the Certificate of Achievement for Excellence in Financial Reporting Program requirements, and we are submitting it to the GFOA to determine its eligibility for another certificate.

### Acknowledgment

This report is the combined effort of many people: Office of Finance and Management accountants, internal auditors, departmental chief fiscal officers, and others. I appreciate their diligent and conscientious work, as well as the efforts of our independent auditors, FORVIS.

Mayor Hogsett, I also appreciate your continued guidance, interest, and support of excellence in accounting and financial reporting.

Respectfully submitted,



**Sarah Riordan**

Controller



Government Finance Officers Association

Certificate of  
Achievement  
for Excellence  
in Financial  
Reporting

Presented to

**City of Indianapolis  
Indiana**

For its Annual Comprehensive  
Financial Report  
For the Fiscal Year Ended

December 31, 2021

*Christopher P. Morill*

Executive Director/CEO



**CITY OF INDIANAPOLIS**  
**ORGANIZATION OF LOCAL GOVERNMENT AND TAXING DISTRICTS**

Introduction

The City of Indianapolis (City) was originally incorporated in 1832. It is the largest city in the State of Indiana (“State”) and the 15th largest city in the nation with a population of 880,621<sup>31</sup> and a metropolitan area population of approximately 2.1 million people. The City encompasses a land area of 402 square miles. The City, located at the geographic center of the State, is the State capital and also serves as the physical, economic, and cultural capital. Indianapolis has a stable and diversified economy with employment rates and income levels consistently above the national averages.

Form of Government

On January 1, 1970, the governments of the City and that of Marion County (“County”) were unified and their form of service delivery consolidated, thereby extending the City’s boundaries to generally coincide with those of the County. Four municipalities (Beech Grove, Lawrence, Speedway, and Southport) located within the County boundaries were specifically excluded from most functions of the consolidated City by the consolidating act. The consolidated government provides for a Mayor and a 25-member legislative council. The City-County Council consists of 25 councillors elected from single-member districts. Because the Mayor’s powers extend to the entire county, residents of the Town of Speedway and the Cities of Beech Grove, Lawrence, and Southport, the municipalities not affected by the reorganization, vote for the Mayor as Chief County Executive.

Since adoption of the consolidated form of government for the City, governmental services within the area of Unigov are provided by 46 different units of local government, including the consolidated City, the County, five independent municipal corporations, 11 school corporations, nine townships, 12 towns, the four municipalities excluded from the consolidated City of Indianapolis, two library boards, and one conservancy district. Within the consolidated City, special taxing districts were created to coincide with user benefit district boundaries then existing or as extended by the consolidating act. Boundaries of the various districts are such that a resident may be a member of one district and not another. Therefore, the resident’s geographic location within the County determines the governmental unit and taxing district rates to be combined in calculating the specific tax rate. As a result of the varying areas in which services are provided by the 46 different governmental units, the County is broken down into 61 different geographical areas for purposes of tax rate determination.

The maps on pages XVII and XVIII illustrate the relationship of the described taxing units.

---

<sup>31</sup> US Census Bureau, Annual Estimates of the Resident Population for Incorporated Places of 50,000 or More, Ranked by July 1, 2022 Population

The following taxing units are within the consolidated City, and all except the consolidated County and the special service districts can issue bonds:

	<u>Map</u>		<u>Map</u>
Civil City	2	Flood Control District	1
Consolidated County	1	Metropolitan Thoroughfare District	1
Redevelopment District	2	Police Special Service District	5
Solid Waste Special Service District	7	Fire Special Service District	6
Public Safety Communications & Computer Facilities District	1	Park District	1

The Metropolitan Thoroughfare District, Flood Control District, Park District, and Public Safety Communications & Computer Facilities District are special taxing districts, the boundaries of which are coterminous with the boundaries of Marion County.

The Redevelopment District and the Solid Waste Disposal District are special taxing districts, the boundaries and taxable property of which are coterminous with the boundaries of the City. The Redevelopment District includes a Consolidated Tax Allocation Area, which captures incremental increases in assessed valuation for the repayment of the Tax Increment Finance Bonds.

### **Other Governmental Units**

The consolidated City of Indianapolis is within the boundaries of Marion County, as are the following:

- **Marion County** as a governmental unit provides services such as courts, sheriff, tax assessment, collection, etc., not otherwise provided by other governmental units.
- The **Capital Improvement Board of Managers of Marion County** (“CIB”) is a separate and distinct municipal corporation with territory coterminous to the territory of Marion County. The CIB is authorized to finance, construct, equip, operate, and maintain any capital facilities or improvements of general public benefit or welfare, which would tend to promote cultural, recreational, public, or civic well-being of the community. The CIB operates facilities used for sports, recreation, and convention activities in downtown Indianapolis. The **Marion County Convention and Recreational Facilities Authority** was created in 1985 under applicable State statutes to provide certain financing for projects of the Board.
- The **Indianapolis Airport Authority** (“Airport Authority”) and the **Health and Hospital Corporation of Marion County** (“HHC”) are separate and distinct municipal corporations with territory coterminous to the territory of Marion County. The Airport Authority was established for the general purpose of acquiring, maintaining, operating, and financing airports and landing fields in and bordering on Marion County. HHC was given the mandate to provide preventative and curative health programs for the residents of the County, including indigent health care.

- The **Indianapolis-Marion County Building Authority** (“Building Authority”) is a separate and distinct municipal corporation that acts as landlord for the City-County Building. The County pays 58% and the City pays 42% of the total lease rental. The Building Authority also has an outstanding bond payable from lease rentals (which are paid from taxes levied) from the County for the Arrestee Processing Center.
- The **Indianapolis Public Transportation Corporation** (“IndyGo”) is a separate and distinct municipal corporation with territory coterminous to the territory of the consolidated Civil City of Indianapolis. IndyGo provides public transportation service within the County.
- The **Indianapolis Marion County Public Library** is a separate and distinct municipal corporation, the territory of which includes the property in Marion County, excluding the Town of Speedway.

There are also several separate school districts in Marion County. In addition to the general obligation bonds of these school districts, various school building corporations have outstanding bonds payable from lease rentals (which are paid from taxes levied) from school districts for the lease of school buildings constructed by the building corporations.

See page XII for the Unigov Organizational Chart and page XIII for the City of Indianapolis Organizational Chart.

Map 1

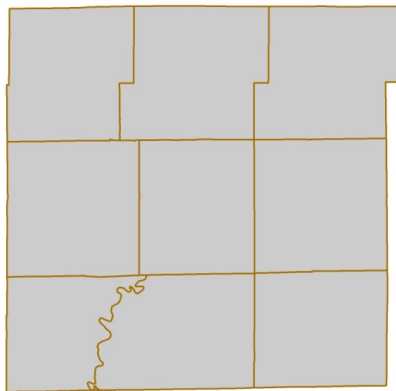

**MARION COUNTY  
AND OTHER INCLUDED  
TOWNS**

Marion County \$49,139,088

Map 2

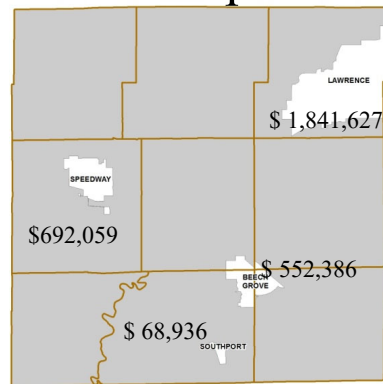

**CONSOLIDATED  
CITY OF INDIANAPOLIS**

City of Indianapolis \$45,984,079  
Excluded Cities and Towns \$3,155,008

Map 3

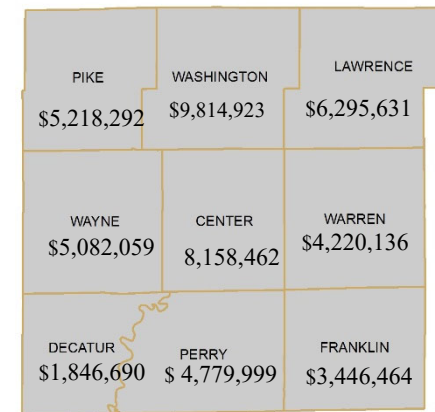

**TOWNSHIPS**

**NOTE:** See Statistical Schedule 13 of Section III of this annual report. The assessed valuation figures are for January 1, 2021 valuations for taxes collectible in 2022.

Map 4

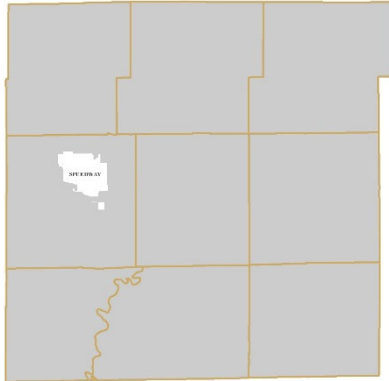

**LIBRARIES**

Speedway	\$692,059
Marion County Libraries	\$48,447,030

Map 5

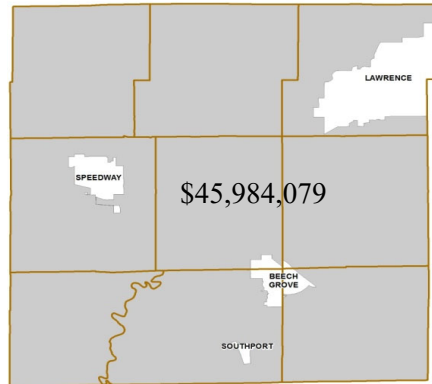

**INDIANAPOLIS**

**POLICE SERVICE DISTRICT**

(Outside of this district, the four excluded cities provide their own police service)

Map 6

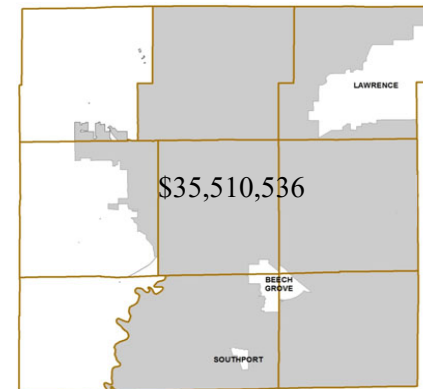

**INDIANAPOLIS**

**FIRE SERVICE DISTRICT**

(Outside of this district, townships and excluded cities provide the fire service)

Map 7

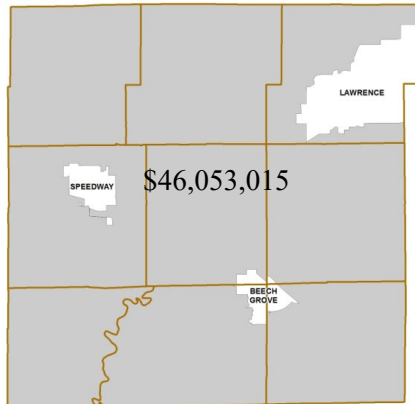

**INDIANAPOLIS SOLID WASTE  
SPECIAL SERVICE DISTRICT**

Map 8

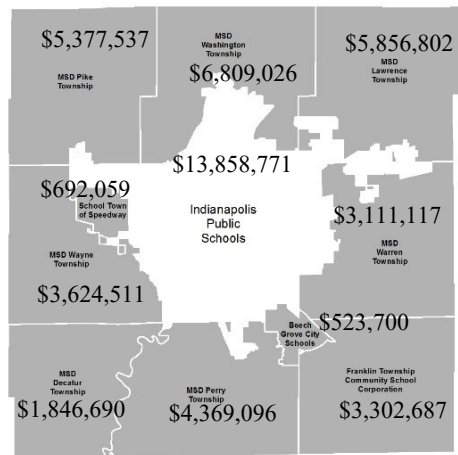

**SCHOOL DISTRICTS**

**NOTE:** See Statistical Schedule 13 of Section III of this annual report. The assessed valuation figures are for January 1, 2021 valuations for taxes collectible in 2022.

**UNIGOV ORGANIZATIONAL CHART  
CONSOLIDATED GOVERNMENT FOR INDIANAPOLIS – MARION COUNTY**

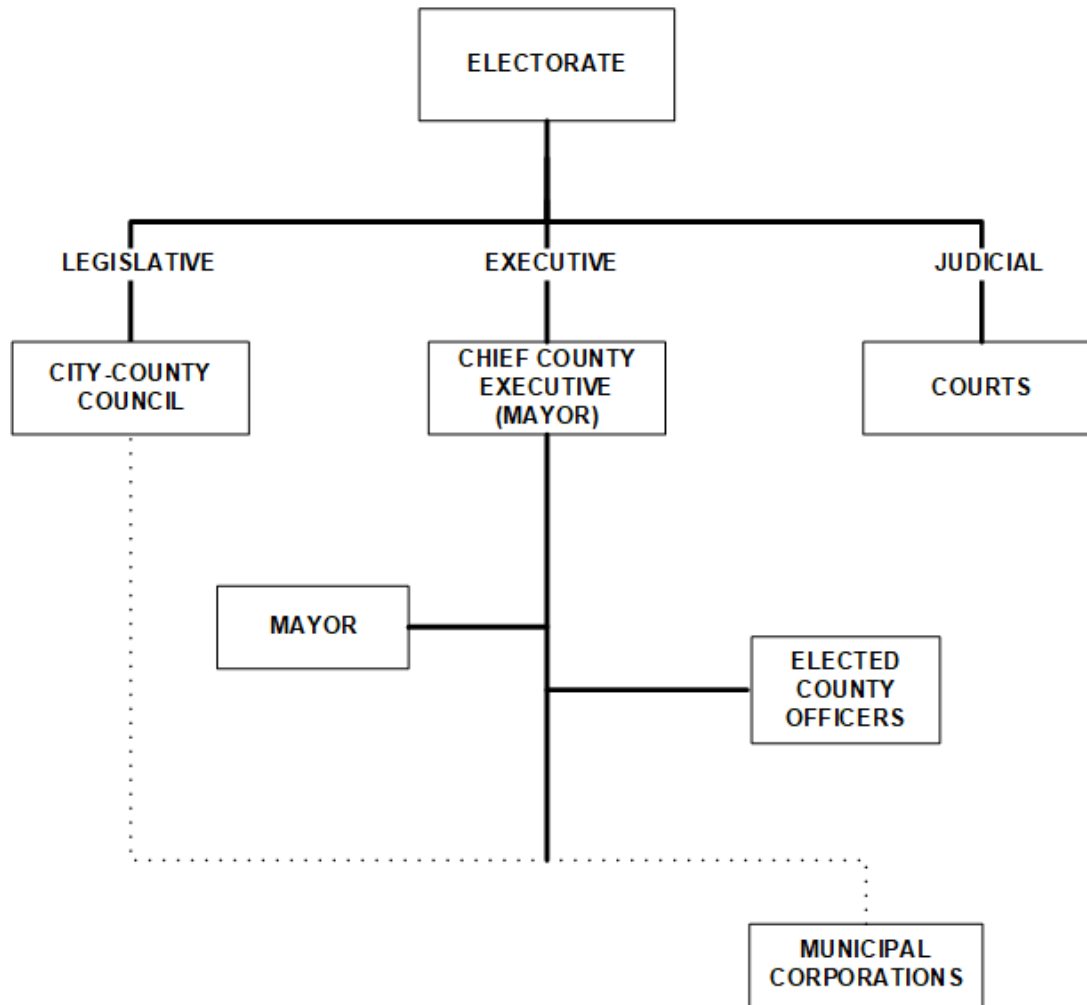

### City of Indianapolis Organization Chart December 31, 2022

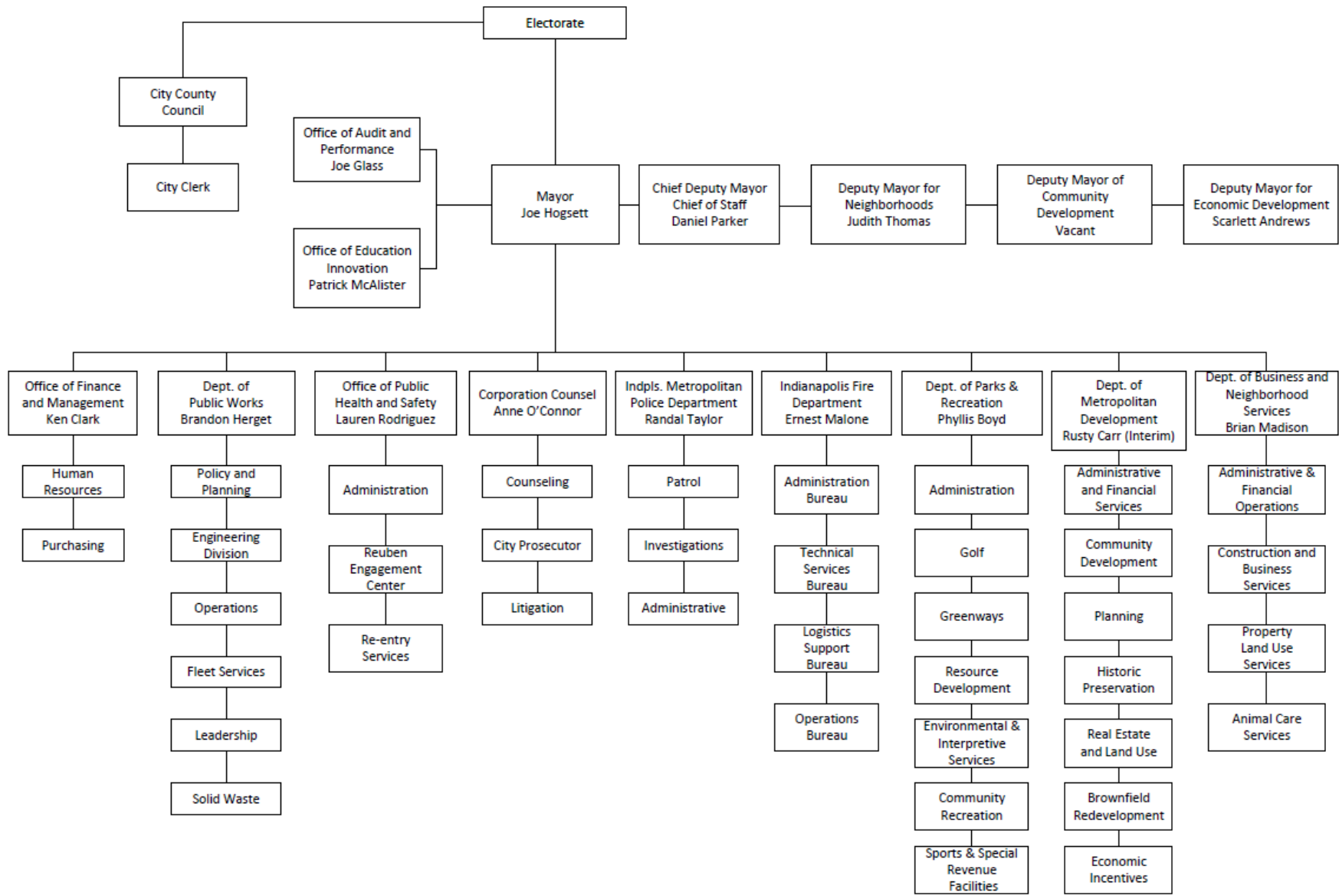

**CITY OF INDIANAPOLIS**  
**SCHEDULE OF ELECTED AND APPOINTED OFFICIALS**

**December 31, 2022**

**Elected Officials\***



**Joe Hogsett, Mayor**  
7 Years of Service  
Mayor and Chief County Executive



**Barbara Lawrence, Ex-Officio City Treasurer**  
2 Years of Service  
Marion County Treasurer

**City-County Councillors**



**Vop Osili, Council President**  
District 11  
12 Years of Service  
Architect/Principal  
A+X Design and Development



**Zach Adamson, Council Vice President**  
District 17  
11 Years of Service  
Owner  
Urban Designs



**Maggie Lewis, Council Majority Leader**  
District 10  
14 Years of Service  
CEO & Executive Director  
Boys and Girls Club of Indianapolis



**Brian Mowery, Council Minority Leader**  
District 25  
7 Years of Service  
Financial Wellness Consultant  
Key Bank

**CITY OF INDIANAPOLIS**  
**SCHEDULE OF ELECTED AND APPOINTED OFFICIALS (Cont.)**

December 31, 2022



**Leroy Robinson**  
 District 1  
 12 Years of Service  
 Director of Major Gifts  
 CICF



**Keith Potts**  
 District 2  
 3 Years of Service  
 City-County Councillor



**Dan Boots**  
 District 3  
 3 Years of Service  
 Partner  
 Dentons Law



**Ethan Evans**  
 District 4  
 3 Years of Service  
 Attendance Assistant  
 North Central High School



**Alison Brown**  
 District 5  
 3 Years of Service  
 Executive Director  
 The Indianapolis Propylaeum



**Crista Carlino**  
 District 6  
 3 Years of Service  
 Director of Development and Communications  
 Workforce Inc. DBA RecycleForce



**John Barth**  
 District 7  
 3 Years of Service  
 Plan President  
 Molina Healthcare of Indiana



**Monroe Gray Jr.**  
 District 8  
 32 Years of Service  
 Retired



**William C. Oliver**  
 District 9  
 19 Years of Service  
 Retired



**Jason Larrison**  
 District 12  
 3 Years of Service  
 Assistant Vice President  
 J.S. Held LLC



**Keith L. Graves**  
 District 13  
 4 Years of Service  
 Financial Services Professional  
 TD Ameritrade



**La Keisha Jackson**  
 District 14  
 8 Years of Service  
 CEO  
 Pathway Resource Center



**CITY OF INDIANAPOLIS**  
**SCHEDULE OF ELECTED AND APPOINTED OFFICIALS (Cont.)**  
**December 31, 2022**



**Jessica McCormick**  
 District 15  
 3 Years of Service  
 Academic Program Coordinator  
 IUPUI—Indiana University



**Kristin Jones**  
 District 16  
 3 Years of Service  
 Executive Director  
 Indiana Senate Democratic Committee



**Michael-Paul Hart**  
 District 18  
 3 Years of Service  
 Director of End User Computing Solutions  
 SHI International



**David Ray**  
 District 19  
 7 Years of Service  
 Administrative Manager  
 Electrical Workers Benefit and Trust Fund



**Joshua Bain**  
 District 20  
 3 Years of Service  
 Virtual Support  
 Proper Cloth



**Frank Mascari**  
 District 21  
 12 Years of Service  
 Jeweler  
 Spalding Jewelry

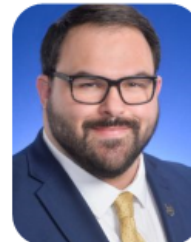

**Jared Evans**  
 District 22  
 7 Years of Service  
 Government Relations & New Project Development  
 Prince Alexander Architects



**Paul Annee**  
 District 23  
 3 Years of Service  
 Executive Director  
 Marion County Agricultural Fair Association



**Michael Dilk**  
 District 24  
 3 Years of Service  
 Property Manager  
 American Homes 4 Rent

\*The term of office for all elected officials expires December 31, 2023 except for the Marion County Treasurer, whose term expires December 31, 2024.

**CITY OF INDIANAPOLIS**  
**SCHEDULE OF ELECTED AND APPOINTED OFFICIALS (cont.)**  
**December 31, 2022**

**APPOINTED OFFICIALS**

<u>Name</u>	<u>Position</u>	<u>Number of Years in This Position</u>	<u>Number of Years Associated with City of Indianapolis – Marion County</u>
Daniel Parker	Chief Deputy Mayor/Chief of Staff	6	6
Judith Thomas	Deputy Mayor for Neighborhoods	2	2
Vacant	Deputy Mayor of Community Development	-	-
Scarlett Andrews	Deputy Mayor for Economic Development	1	6
Patrick McAlister	Director of Office of Education Innovation	7	7
Ken Clark	Controller - Office of Finance and Management	3	10
Anne O'Connor	Corporation Counsel	3	7
Rusty Carr	Interim Director of Metropolitan Development	1	8
Brandon Herget	Director of Public Works	1	3
Phyllis Boyd	Director of Parks and Recreation	2	2
Brian Madison	Director of Business and Neighborhood Services	5	13
Lauren Rodriguez	Director of Office of Public Health and Safety	2	2
SaRita Hughes	Clerk of the City-County Council	5	11
Joe Glass	Director of Office of Audit and Performance	2	2

**CERTIFIED PUBLIC ACCOUNTANTS**

FORVIS

Financial Section

# Financial Section

## Independent Auditor's Report

To the Honorable Mayor and Members of the City-County Council  
City of Indianapolis, Indiana

### Report on the Audit of the Financial Statements

#### *Opinions*

We have audited the financial statements of the governmental activities, the discretely presented component unit, each major fund, and the aggregate remaining fund information of the City of Indianapolis (City), a component unit of the Consolidated City of Indianapolis-Marion County, as of and for the year ended December 31, 2022, and the related notes to the financial statements, which collectively comprise the City's basic financial statements as listed in the table of contents.

In our opinion, based on our audit and the report of the other auditors, the accompanying financial statements referred to above present fairly, in all material respects, the respective financial position of the governmental activities, the discretely presented component unit, each major fund, and the aggregate remaining fund information of the City, as of December 31, 2022, and the respective changes in financial position, and, where applicable, cash flows thereof for the year then ended in accordance with accounting principles generally accepted in the United States of America.

We did not audit the financial statements of the Indianapolis Housing Agency, which represents 100% of the assets, net position and revenues of the City's discretely presented component unit as of December 31, 2022. Those statements were audited by other auditors whose report has been furnished to us, and our opinion, insofar as it relates to the amounts included for the Indianapolis Housing Agency is based solely on the report of the other auditors.

#### *Basis for Opinions*

We conducted our audit in accordance with auditing standards generally accepted in the United States of America (GAAS) and the standards applicable to financial audits contained in *Government Auditing Standards*, issued by the Comptroller General of the United States (*Government Auditing Standards*). Our responsibilities under those standards are further described in the "Auditor's Responsibilities for the Audit of the Financial Statements" section of our report. We are required to be independent of the City, and to meet our other ethical responsibilities, in accordance with the relevant ethical requirements relating to our audit. We believe that the audit evidence we have obtained is sufficient and appropriate to provide a basis for our audit opinions.

#### *Emphasis of Matter*

As discussed in Note 1 to the financial statements, in 2022, the City adopted Governmental Accounting Standards Board Statement No. 87, *Leases*. Our opinions are not modified with respect to this matter.

## ***Responsibilities of Management for the Financial Statements***

Management is responsible for the preparation and fair presentation of the financial statements in accordance with accounting principles generally accepted in the United States of America, and for the design, implementation, and maintenance of internal control relevant to the preparation and fair presentation of financial statements that are free from material misstatement, whether due to fraud or error.

In preparing the financial statements, management is required to evaluate whether there are conditions or events, considered in the aggregate, that raise substantial doubt about the City's ability to continue as a going concern for 12 months beyond the financial statement date, including any currently known information that may raise substantial doubt shortly thereafter.

## ***Auditor's Responsibilities for the Audit of the Financial Statements***

Our objectives are to obtain reasonable assurance about whether the financial statements as a whole are free from material misstatement, whether due to fraud or error, and to issue an auditor's report that includes our opinions. Reasonable assurance is a high level of assurance but is not absolute assurance and therefore is not a guarantee that an audit conducted in accordance with GAAS and *Government Auditing Standards* will always detect a material misstatement when it exists. The risk of not detecting a material misstatement resulting from fraud is higher than for one resulting from error, as fraud may involve collusion, forgery, intentional omissions, misrepresentations, or the override of internal control. Misstatements are considered material if there is a substantial likelihood that, individually or in the aggregate, they would influence the judgment made by a reasonable user based on the financial statements.

In performing an audit in accordance with GAAS and *Government Auditing Standards*, we:

- Exercise professional judgment and maintain professional skepticism throughout the audit.
- Identify and assess the risks of material misstatement of the financial statements, whether due to fraud or error, and design and perform audit procedures responsive to those risks. Such procedures include examining, on a test basis, evidence regarding the amounts and disclosures in the financial statements.
- Obtain an understanding of internal control relevant to the audit in order to design audit procedures that are appropriate in the circumstances, but not for the purpose of expressing an opinion on the effectiveness of the City's internal control. Accordingly, no such opinion is expressed.
- Evaluate the appropriateness of accounting policies used and the reasonableness of significant accounting estimates made by management, as well as evaluate the overall presentation of the financial statements.
- Conclude whether, in our judgment, there are conditions or events, considered in the aggregate, that raise substantial doubt about the City's ability to continue as a going concern for a reasonable period of time.

We are required to communicate with those charged with governance regarding, among other matters, the planned scope and timing of the audit, significant audit findings, and certain internal control-related matters that we identified during the audit.

## ***Required Supplementary Information***

Accounting principles generally accepted in the United States of America require that the management's discussion and analysis, budgetary comparison, pension, and other postemployment benefit information be presented to supplement the basic financial statements. Such information is the responsibility of management and, although not a part of the basic financial statements, is required by the Governmental Accounting Standards Board, who considers it to be an essential part of financial reporting for placing the basic financial statements in an appropriate operational, economic, or historical context. We have applied certain limited procedures to the required supplementary information in accordance with auditing standards generally accepted in the United States of America, which consisted of inquiries of management about the methods of preparing the information and comparing the information for consistency with management's responses to our inquiries, the basic financial statements, and other knowledge we obtained during our audit of the basic financial statements. We do not express an opinion or provide any assurance on the information because the limited procedures do not provide us with sufficient evidence to express an opinion or provide any assurance.

## ***Supplementary Information***

Our audit was conducted for the purpose of forming opinions on the financial statements that collectively comprise the City's basic financial statements. The combining and individual fund financial statements and schedules – other supplementary information, as listed in the table of contents, are presented for purposes of additional analysis and are not a required part of the basic financial statements. Such information is the responsibility of management and was derived from and relates directly to the underlying accounting and other records used to prepare the basic financial statements. The information has been subjected to the auditing procedures applied in the audit of the basic financial statements and certain additional procedures, including comparing and reconciling such information directly to the underlying accounting and other records used to prepare the basic financial statements or to the basic financial statements themselves, and other additional procedures in accordance with auditing standards generally accepted in the United States of America. In our opinion, the combining and individual fund financial statements and schedules – other supplementary information is fairly stated, in all material respects, in relation to the basic financial statements as a whole.

## ***Other Information***

Management is responsible for the other information included in the annual report. The other information comprises the introductory and statistical sections, as listed in the table of contents, but does not include the basic financial statements and our auditor's report thereon. Our opinions on the basic financial statements do not cover the other information, and we do not express an opinion or any form of assurance thereon.

In connection with our audit of the basic financial statements, our responsibility is to read the other information and consider whether a material inconsistency exists between the other information and the basic financial statements, or the other information otherwise appears to be materially misstated. If, based on the work performed, we conclude that an uncorrected material misstatement of the other information exists, we are required to describe it in our report.

## ***Other Reporting Required by Government Auditing Standards***

In accordance with *Government Auditing Standards*, we have also issued our report dated October 17, 2023, on our consideration of the City's internal control over financial reporting and on our tests of its compliance with certain provisions of laws, regulations, contracts and grant agreements, and other matters. The purpose of that report is solely to describe the scope of our testing of internal control over financial reporting and compliance and the results of that testing, and not to provide an opinion on the effectiveness of the City's internal control over financial reporting or on compliance. That report is an integral part of an audit performed in accordance with *Government Auditing Standards* in considering the City's internal control over financial reporting and compliance.

**FORVIS, LLP**

Indianapolis, Indiana  
October 17, 2023

**(This page intentionally left blank)**



Management's  
Discussion and Analysis

# Management's Discussion and Analysis

**CITY OF INDIANAPOLIS**  
**(A Component Unit of the Consolidated City of Indianapolis – Marion County)**  
**Management’s Discussion and Analysis**  
**Year ended December 31, 2022**

This Annual Comprehensive Financial Report presents an analysis of the financial activities of the City of Indianapolis (“City”) for the year ended December 31, 2022 based on currently known facts, decisions, and conditions. For a comprehensive understanding of the financial statements, please review the transmittal letter at the front of this report, along with the City’s financial statements, including the footnotes that follow the basic financial statements.

**FINANCIAL HIGHLIGHTS**

- On a government-wide basis, the City’s assets and deferred outflows exceeded its liabilities and deferred inflows at December 31, 2022 by \$485.8 million, which represents the total net position of the City’s governmental activities. Included in this net position amount is a \$920.6 million unrestricted deficit, due mainly to an unfunded net pension liability of \$749.7 million and an unfunded postemployment benefit obligation of \$215.8 million. The State of Indiana, in 2008, agreed to reimburse the cities and towns of Indiana for pension costs for members of the pre-1977 pensions plans, effective January 1, 2009. Therefore, although unfunded, these pension benefits, which represent \$564.3 million, or 75%, of the total net pension liabilities, will be covered by the State of Indiana. Regarding the unfunded postemployment benefit obligation, there is no intent by the City or legal requirement to fund this long-term liability beyond the annual payments required by existing labor agreements. See footnotes 14 and 15 to the financial statements for further discussion of the City’s other postemployment benefits and pension plans, respectively.
- On a government-wide basis, for 2022, the City’s total expenses were \$1,046.6 million or \$293.3 million less than the \$1,339.9 million generated in charges for services, grants, taxes, and other revenues.
- As of December 31, 2022, the City’s governmental funds reported combined ending fund balances of \$1,088.2 million. Of this amount, \$0.4 million was nonspendable, \$801.8 million was restricted, \$72.5 million was committed, \$105.2 million was assigned, and \$108.3 million was unassigned.
- The unassigned fund balance for the general fund was \$118.6 million or 14% of total general fund expenditures. The City’s policy is to maintain an unassigned general fund balance of at least 10% of total general fund expenditures. The unrestricted fund balance, which includes the committed, assigned, and unassigned fund balances, was \$236.1 million or 27% of total general fund expenditures. The City’s policy is to maintain an unrestricted general fund balance of at least 17% of total general fund expenditures. These policies were formally adopted in ordinance by the City-County Council in 2016.

**OVERVIEW OF FINANCIAL STATEMENTS**

This discussion and analysis is intended to serve as an introduction to the City’s basic financial statements. The City’s basic financial statements include three components: (1) government-wide financial statements, (2) fund financial statements, and (3) notes to the basic financial statements.

**CITY OF INDIANAPOLIS**  
**(A Component Unit of the Consolidated City of Indianapolis – Marion County)**  
**Management’s Discussion and Analysis**  
**Year ended December 31, 2022**

**Government-wide Financial Statements**

The first set of financial statements are the government-wide statements, which report information about the City as a whole using accounting methods similar to those used by private sector companies. The two government-wide statements, **Statement of Net Position** and **Statement of Activities**, report the City’s net position and how it has changed. Governmental activities are those normally associated with the operation of a government, such as public safety, parks, and public works. The City’s government-wide financial statements also include a discretely presented component unit, the Indianapolis Housing Agency. The remaining discussions and analysis focuses on the primary government only.

The **Statement of Net Position** presents information on all of the City’s assets, deferred outflows, liabilities, and deferred inflows, with the remainder being reported as net position. Increases and decreases in net position may serve as a useful indicator of whether or not the financial position of the City is improving or deteriorating. The statement of net position also provides information on unrestricted and restricted net position and the net investment in capital assets.

The **Statement of Activities** presents information showing how the City’s net position changed during the year. All current year’s revenues and expenses are accounted for in the statement of activities regardless of the timing of related cash flows. The statement of activities presents the various functions of the City and the extent to which they are supported by charges for services, grants and contributions, taxes, and investment income. The governmental activities of the City include: general government, public safety, public works, health and welfare, cultural and recreation, urban redevelopment and housing, and economic development and assistance.

**Fund Financial Statements**

The second set of financial statements is the fund financial statements, which provide information about groupings of related accounts which are used to maintain control over resources for specific activities or objectives. The City uses fund accounting to demonstrate compliance with finance-related legal requirements. The fund financial statements provide more detailed information about the City’s most significant funds – not the City as a whole. The funds of the City can be divided into the following three categories: *governmental funds*, *proprietary funds*, and *fiduciary funds*.

1. *Governmental Funds*. Governmental funds tell how general government services were financed in the short term, as well as what financial resources remain available for future spending to finance City programs.

The City maintains several individual governmental funds according to their type (general, special revenue, debt service, capital projects, and permanent). Information is presented separately in the governmental fund balance sheet and in the governmental fund statement of revenues, expenditures, and changes in fund balances for the General Fund, Coronavirus Federal Stimulus Fund, Revenue Bond Debt Service Fund, and Redevelopment District Tax Increment Capital Project Fund, which are considered to be major funds. Individual fund data for each of the nonmajor governmental funds are provided in the form of combining statements as supplementary information.

2. *Proprietary Funds*. Proprietary funds offer short-term and long-term financial information about services for which the City charges customers, both external customers and internal departments of the City. The City maintains the following type of proprietary funds:

**CITY OF INDIANAPOLIS**  
**(A Component Unit of the Consolidated City of Indianapolis – Marion County)**  
**Management’s Discussion and Analysis**  
**Year ended December 31, 2022**

- *Internal Service Funds* are used to report activities that provide services for certain City programs and activities. The City uses internal service funds to provide for the financing of workers’ compensation, auto liability, employee health insurance, and public liability self-insurance for all City departments, as well as for the centralization of certain payments of awards, refunds, and indemnities.
3. *Fiduciary Funds*. Fiduciary funds are used to account for resources held for the benefit of individuals or units of other governments. The City is the trustee or fiduciary responsible for assets that can be used for the trust beneficiaries per trust arrangements. The City is responsible for ensuring that the assets reported in these funds are used for their intended purposes. All the City’s fiduciary activities are reported in a separate statement of fiduciary net position and a statement of changes in fiduciary net position. The City’s pension trust funds and custodial funds are reported under the fiduciary funds. Since the resources of these funds are not available to support the City’s own programs, they are not reflected in the government-wide financial statements.

**Notes to the Basic Financial Statements**

The notes to the basic financial statements provide additional information that is essential to a full understanding of the data provided in the government-wide and fund financial statements.

**Required Supplementary Information**

In addition to the basic financial statements and notes to the basic financial statements, this report presents required supplementary information concerning the City’s budgetary comparisons for the general fund, as well as required supplementary information pertaining to the City’s progress in funding its obligation to provide pension and other postemployment benefits to its employees.

**Additional Supplementary Information**

The combining statements provide subfund-level detail for the general fund and fund-level detail for all nonmajor governmental funds, internal service funds, pension trust funds, and custodial funds. Also in this section are comparisons of actual to budget for all other annually budgeted funds.

**CITY OF INDIANAPOLIS**  
**(A Component Unit of the Consolidated City of Indianapolis – Marion County)**  
**Management’s Discussion and Analysis**  
**Year ended December 31, 2022**

**FINANCIAL ANALYSIS OF THE CITY AS A WHOLE**

**Net position.** The City’s governmental activities net position at December 31, 2022 and 2021 was \$485.8 million and \$174.6 million, respectively.

**Statement of Net Position**  
*(In thousands)*

	<b>Governmental activities 2022</b>	<b>Governmental activities 2021 (1)</b>
<b>Assets:</b>		
Current and other assets	\$ 1,590,470	\$ 1,517,620
Capital and leased assets, net of accumulated depreciation	1,806,559	1,665,879
Total assets	3,397,029	3,183,499
<b>Deferred outflows of resources</b>		
	263,928	195,203
Total assets and deferred outflows of resources	3,660,957	3,378,702
<b>Liabilities:</b>		
Other liabilities	481,716	445,869
Long-term liabilities	2,577,415	2,447,761
Total liabilities	3,059,131	2,893,630
<b>Deferred inflows of resources</b>		
	116,065	310,442
Total liabilities and deferred inflows of resources	3,175,196	3,204,072
<b>Net position:</b>		
Net investment in capital assets	973,164	856,341
Restricted	433,235	572,906
Unrestricted (deficit)	(920,638)	(1,254,617)
Total net position	\$ 485,761	\$ 174,630

- (1) The balances for the year ended December 31, 2021 have not been restated to reflect the adoption of GASB Statement No. 87, *Leases*. See Note 1 for additional information regarding adoption of this standard.

**ANALYSIS OF NET POSITION**

As noted earlier, net position may serve as a useful indicator of a government’s financial position. The largest portion of the City’s net position reflects its investments of \$973.2 million in capital assets (e.g., net book value of land, buildings, equipment, and infrastructure, less related outstanding debt used to acquire those assets). The 2021 balance was \$856.3 million. The City uses these capital assets to provide services to citizens; consequently, these assets are not available for future spending. Although the City’s investment in capital assets is reported net of related debt, it

**CITY OF INDIANAPOLIS**  
**(A Component Unit of the Consolidated City of Indianapolis – Marion County)**  
**Management’s Discussion and Analysis**  
**Year ended December 31, 2022**

should be noted that resources needed to repay this debt must be provided from other sources, since the capital assets themselves cannot be liquidated for these liabilities. Included in the City’s total net position is \$433.2 million, versus \$572.9 million in 2021, which represents resources that are subject to external restrictions on how they may be used.

All net position generated by governmental activities are either externally restricted, restricted by enabling legislation, or invested in capital assets.

Consequently, unrestricted governmental net position showed a \$920.6 million deficit at the end of the year as compared to a \$1,254.6 million deficit for the prior year. This deficit does not mean the City does not have resources available to pay its bills. Rather, it is the result of having long-term commitments that are greater than currently available resources, mainly net pension liabilities of \$749.7 million and postemployment obligations of \$215.8 million.

**Change in net position.** The City’s total revenue (including transfers) on a government-wide basis for 2022 was \$1,339.9 million and \$1,264.4 million for 2021. Taxes represent 53% of the City’s revenue (58% for 2021). Another 9% of revenue (9% in 2021) came from fees charged for services, and the remainder came from grants and contributions, interest earnings, and miscellaneous revenues.

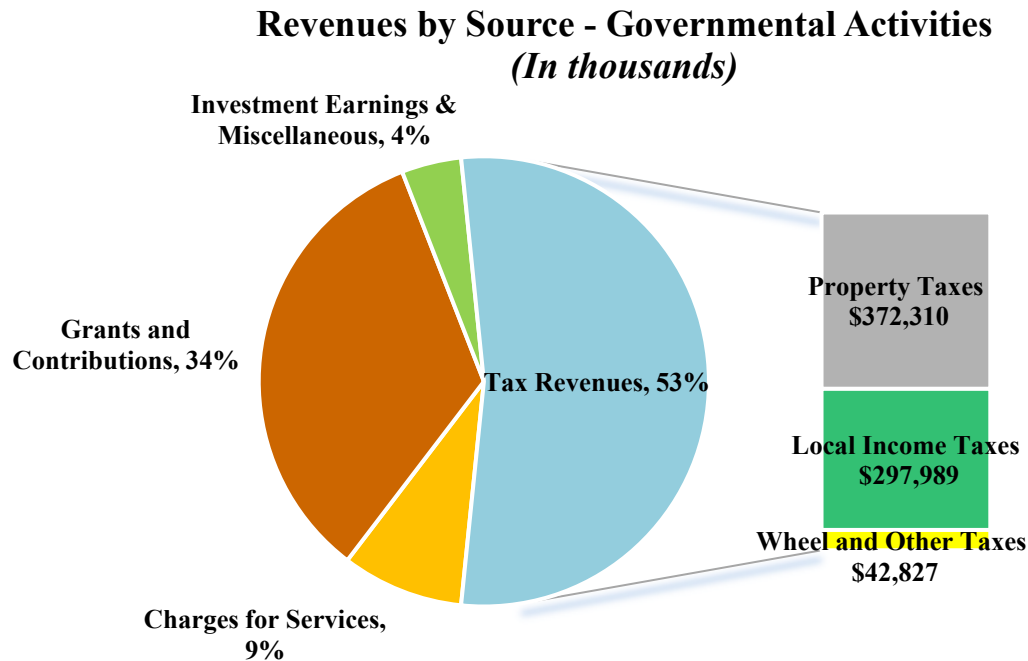

**CITY OF INDIANAPOLIS**  
**(A Component Unit of the Consolidated City of Indianapolis – Marion County)**  
**Management’s Discussion and Analysis**  
**Year ended December 31, 2022**

The changes in net position for the years ended December 31, 2022 and 2021 are as follows:

**Schedule of Changes in Net Position**  
**For the Years Ended December 31, 2022 and 2021**  
*(In thousands)*

	<b>Governmental activities 2022</b>	<b>Governmental activities 2021 (1)</b>
<b>Revenues:</b>		
Program revenues		
Charges for services	\$ 117,440	\$ 116,245
Operating grants and contributions	431,033	321,159
Capital grants and contributions	10,079	20,655
General revenues:		
Property tax	372,310	364,859
Local income tax	297,989	327,197
Other taxes	42,827	43,063
Other general revenues	68,242	71,250
Total revenues	1,339,920	1,264,428
<b>Expenses:</b>		
General government	144,690	53,482
Public safety	427,683	480,821
Public works	268,945	245,433
Health and welfare	21,141	13,886
Cultural and recreation	33,593	25,873
Urban redevelopment and housing	63,483	151,317
Economic development and assistance	30,375	61,089
Interest	56,702	50,128
Total expenses	1,046,612	1,082,029
Change in net position	293,308	182,399
Net position (deficit), beginning of year, as previously reported	174,630	(7,769)
Change in accounting principle	17,823	—
Net position (deficit), beginning of year, as restated	192,453	(7,769)
Net position, ending	\$ 485,761	\$ 174,630

(1) The balances for the year ended December 31, 2021 have not been restated to reflect the adoption of GASB Statement No. 87, *Leases*. See Note 1 for additional information regarding adoption of this standard.



**CITY OF INDIANAPOLIS**  
**(A Component Unit of the Consolidated City of Indianapolis – Marion County)**  
**Management’s Discussion and Analysis**  
**Year ended December 31, 2022**

**Governmental Activities Change in Net Position**  
*(In thousands)*

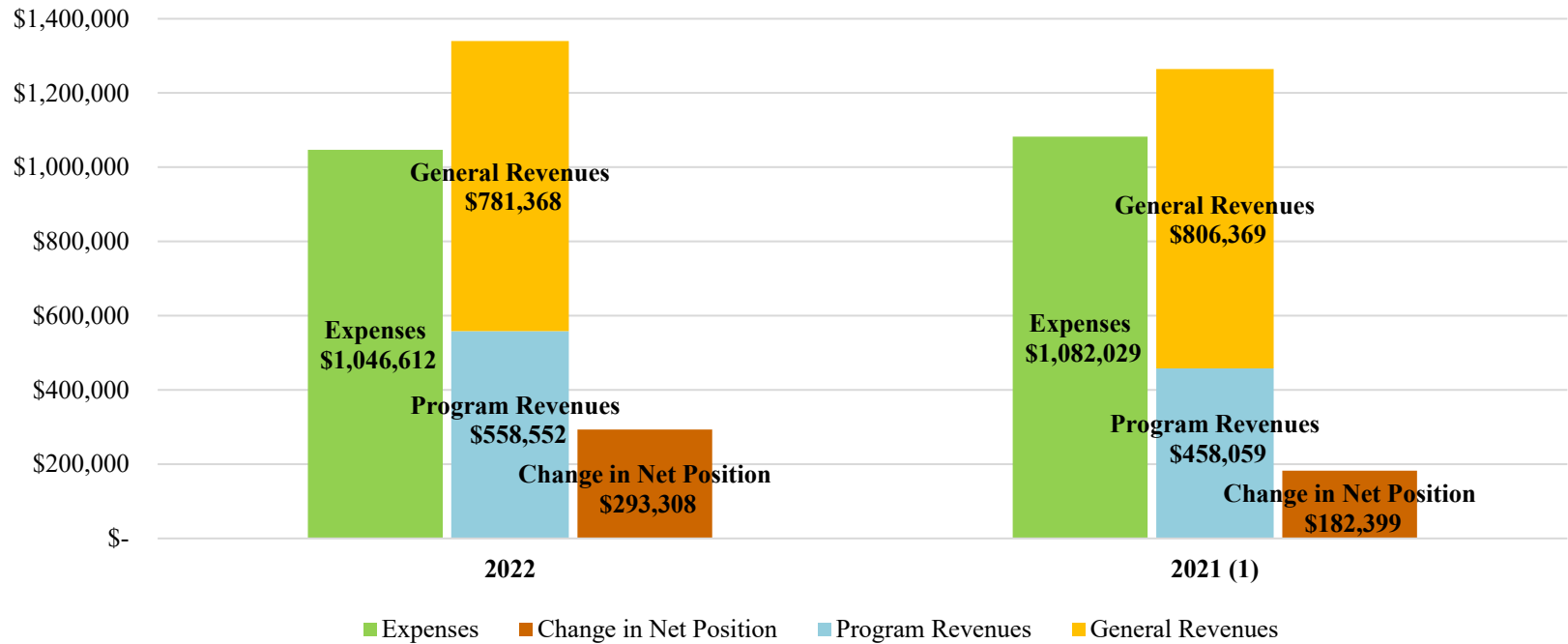

(1) The balances for the year ended December 31, 2021 have not been restated to reflect the adoption of GASB Statement No. 87, *Leases*. See Note 1 for additional information regarding adoption of this standard.

**Governmental activities.** The City’s governmental activities net position increased by \$293.3 million compared to an increase of \$182.4 million in the prior year. Key elements of the increase are as follows:

Total expenses for governmental activities for 2022 were \$1,046.6 million, a decrease of \$35.4 million from the prior year, attributed to the following:

**CITY OF INDIANAPOLIS**  
**(A Component Unit of the Consolidated City of Indianapolis – Marion County)**  
**Management’s Discussion and Analysis**  
**Year ended December 31, 2022**

- General Government expenditures increased \$91.2 million; \$46.5 million of the increase is in the Coronavirus Federal Stimulus fund associated with expenditures related to American Rescue Plan Act (“ARPA”) programs. In addition, we saw an increase of general government expenditures, attributed to the planned spenddown of funds that have been set aside since the inception of the Community Justice Campus (“CJC”) project. These excess funds were committed to the completion of the Adult Detention and Courthouse Facilities as well as costs associated with opening the Community Justice Campus.
- Public safety expenditures decreased \$53.1 million, mainly attributable to a decrease in pension expense of \$84.6 million, the changes in pension expense from year to year are a direct result of the assumptions used in the actuarial valuations for the City’s pension plans. In addition, there was an increase of \$26.3 million in expenditures related to ARPA programs.
- Public works expenditures increased \$23.5 million, which is mainly attributed to adjustments made related to infrastructure additions.
- Health and welfare expenditures increased \$7.3 million, this is mainly related to programs associated with federal funding received under the ARPA.
- Culture and recreation expenditures increased \$7.7 million, which is mainly attributed to adjustments related to capital assets.
- Urban redevelopment and housing expenditures decreased \$87.8 million, which was related to federal funding that was deployed in 2021, received under the American Rescue Plan Act, which established rental assistance for Marion County residents who were economically impacted because of the COVID-19 crisis.
- Economic development expenditures decreased \$30.7 million, mainly associated with a decrease in non-major capital project funds, related to the timing of economic development and tax increment financing project activity.

Total governmental activities revenues in 2022 were \$1,339.9 million, an increase of \$75.5 million from the prior year, attributed to the following:

- The City saw an increase in property taxes of \$7.5 million, which was driven by overall growth in assessed values and strong collections in 2022.
- The City saw a decrease in local income tax of \$29.2 million, due to the allocation of income taxes between the City and County. The decrease attributed to \$12 million being allocated to the County, as part of a reorganization of the Metropolitan Emergency Services Agency, which was effective January 1, 2022. The remaining \$17.2 million decrease is attributable to a discretionary decision made by the Office of Finance and Management (“OFM”) to allocate more to the County, along with an impact in decreased collections as a direct result of the COVID-19 pandemic.

**CITY OF INDIANAPOLIS**  
**(A Component Unit of the Consolidated City of Indianapolis – Marion County)**  
**Management’s Discussion and Analysis**  
**Year ended December 31, 2022**

- The City saw an increase of \$109.8 million in operating grants and contributions in 2022, mainly associated with a \$71.2 million grant from Lilly Endowment, which will be used towards improvement across Indianapolis’ Parks. In addition, the City recognized \$20.4 million in revenue related to the nationwide opioid litigation settlements, brought by states and local political subdivisions against three pharmaceutical distributors and one manufacturer of opioids. See note 8 for additional information related to the opioid settlement.

**FINANCIAL ANALYSIS OF THE CITY’S FUNDS**

The focus of the City’s governmental funds is to provide information on inflows and balances of resources that are available for spending. An unassigned fund balance may serve as a useful measure of a government’s net resources available for spending at the end of the year. At December 31, 2022, the unassigned fund balance of the General Fund was \$118.6 million (as compared to \$142.4 million in 2021) while the total General Fund balance was \$327.8 million (as compared to \$422.5 million in 2021). As a measure of the General Fund’s liquidity, it may be useful to compare both unassigned fund balance and total fund balance to total fund expenditures and transfers out. Unassigned fund balance represents 13% of total General Fund expenditures and transfers out (as compared to 17% for 2021), while total fund balance represents 35% (50% for 2021) of total General Fund expenditures and transfers out.

The fund balance in the City’s General Fund decreased by \$94.7 million or 22% during the year-ended December 31, 2022.

Total general fund revenues, not including other financing sources, totaled \$752.4 million, a decrease of \$32.7 million or 4%. Significant revenues in the general fund that decreased from 2021 to 2022 include:

- Taxes decreased by \$20 million, mainly attributed to a decrease in income taxes in the amount of \$26 million. \$12 million of the decrease is attributable to the creation of the Metropolitan Emergency Services Agency (“MESA”), a new County department, effective January 1, 2022. MESA was created by taking siloed portions of other divisions within the City-County Enterprise and uniting them under one common department to ensure that emergency management operations are being coordinated and centralized. This new department consists of the former 911 Dispatchers from the Marion County Sheriff’s Department, the division of Homeland Security from the Indianapolis Metropolitan Police Department, the division of Communications from the Office of Public Health and Safety, and telecommunicators from the Indianapolis Fire Department. Due to this reorganization, income taxes of \$12 million were shifted from the City to the County. The remaining \$14 million decrease is attributable to a discretionary decision made by OFM to allocate more to the County, along with an impact in decreased collections as a direct result of the COVID-19 pandemic. While we saw a decrease in income taxes, there was an increase in property taxes of \$6 million due to growth in assessed values.
- Other intergovernmental revenues decreased by \$10.4 million; \$14.5 million of the decrease in other intergovernmental revenues relates to the City receiving revenue in 2021 from the County’s Community Justice Campus subfund related to the completion of the CJC facilities, as final purchase orders were issued by the City. The City also saw an increase in state revenues of \$3.1 million mainly associated with an increase in gasoline taxes and a \$1 million increase in federal revenues related to infrastructure projects associated with the federal highway program.

**CITY OF INDIANAPOLIS**  
**(A Component Unit of the Consolidated City of Indianapolis – Marion County)**  
**Management’s Discussion and Analysis**  
**Year ended December 31, 2022**

Total general fund expenditures, not including other financing uses, totaled \$866.0 million, an increase of \$72.0 million or 9%, which is mainly attributed to the following:

- General government expenditures increased by \$63.9 million attributed to the planned spenddown of funds that have been set aside since the inception of the Community Justice Campus project. These excess funds were committed to the completion of the Adult Detention and Courthouse Facilities as well as costs associated with opening the Community Justice Campus.
- Public Safety expenditures increased by \$9 million, mainly associated with increases for public safety sworn personnel in accordance with collective bargaining agreements.

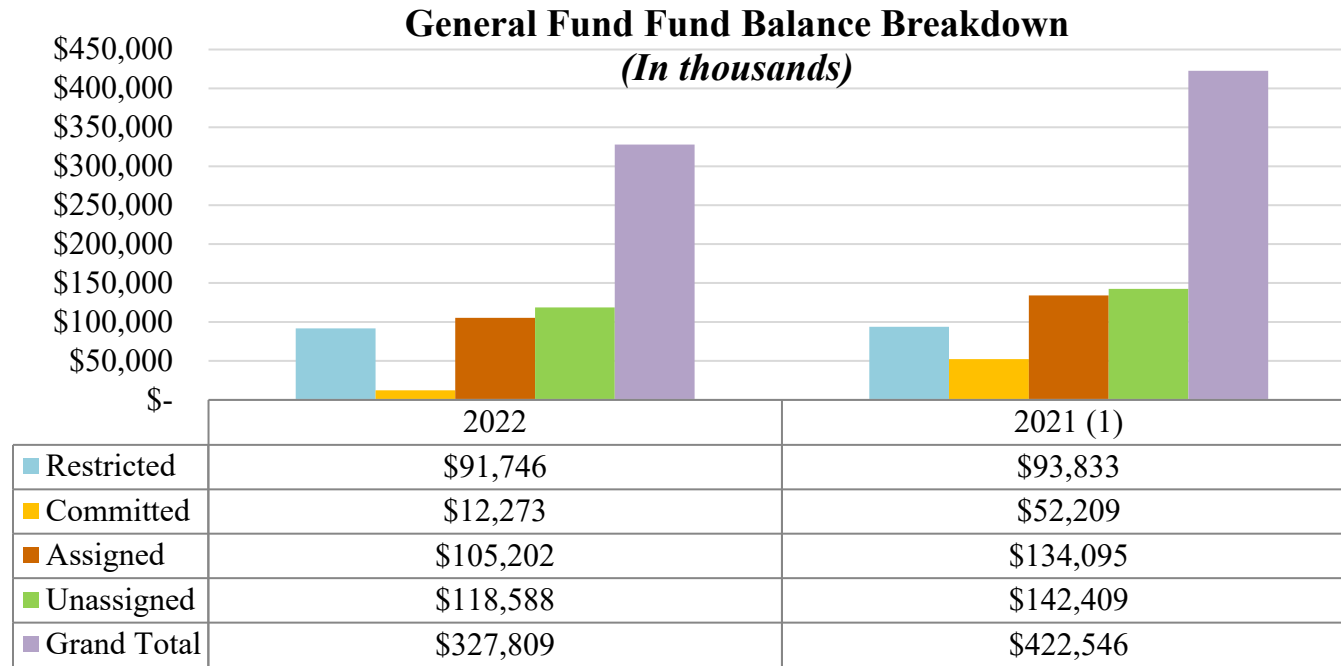

(1) The balances for the year ended December 31, 2021 have not been restated to reflect the adoption of GASB Statement No. 87, *Leases*. See Note 1 for additional information regarding adoption of this standard.

**CITY OF INDIANAPOLIS**  
**(A Component Unit of the Consolidated City of Indianapolis – Marion County)**  
**Management’s Discussion and Analysis**  
**Year ended December 31, 2022**

**General Fund Change in Fund Balance**  
*(In thousands)*

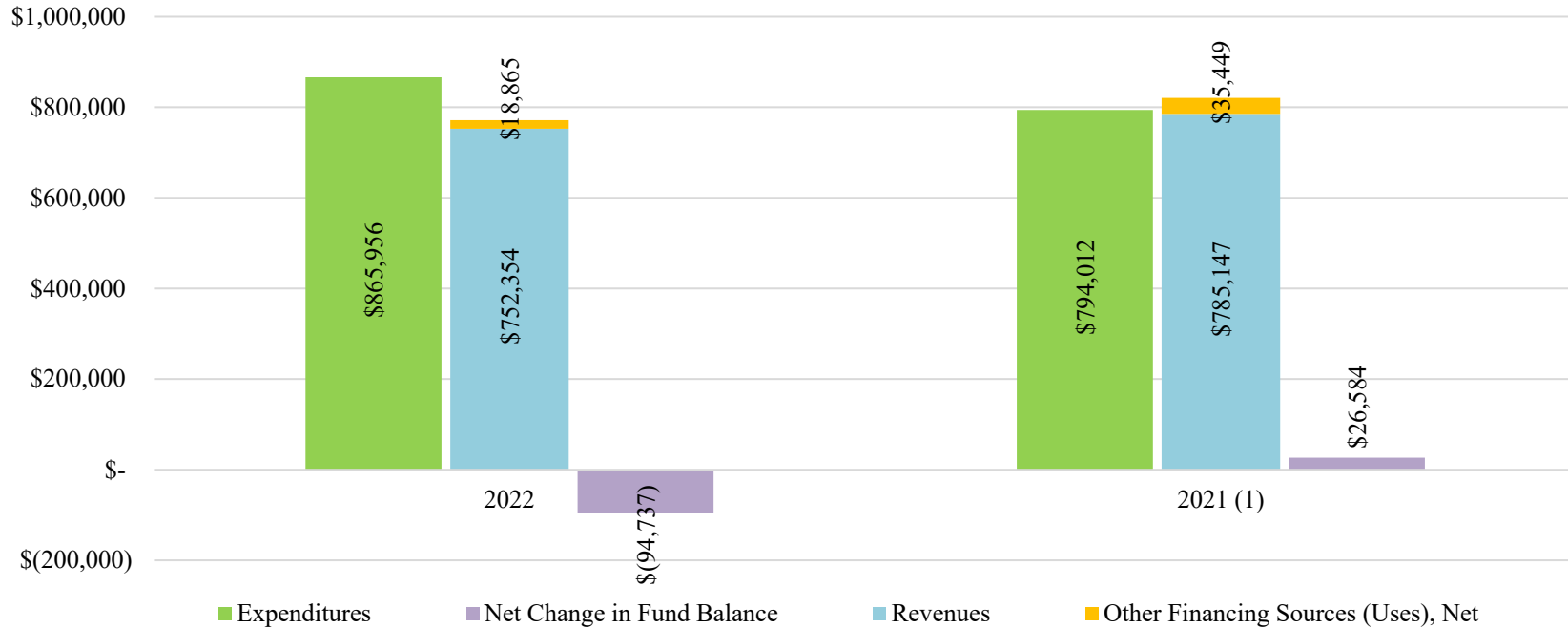

(1) The balances for the year ended December 31, 2021 have not been restated to reflect the adoption of GASB Statement No. 87, *Leases*. See Note 1 for additional information regarding adoption of this standard.

The Coronavirus Federal Stimulus Fund ended the year with a (\$1.3) million deficit fund balance (as compared to \$0.1 million in 2021). During 2022, the City received the final stimulus distribution in the amount of \$210 million via the Coronavirus State and Local Fiscal Recovery Funds authorized by the American Rescue Plan Act. The \$210 million represents the second 50% installment of the City’s entire \$420 million allocation. The federal dollars related to the program are reported as unearned income on the balance sheet.

The Revenue Debt Service Fund ended the year with a \$202.9 million fund balance (as compared to \$165.7 million in 2021), which was restricted for debt service. The fund balance for the Revenue Debt Service Fund increased by \$37.2 million, of which \$5.5 million is attributed to growth in

**CITY OF INDIANAPOLIS**  
**(A Component Unit of the Consolidated City of Indianapolis – Marion County)**  
**Management’s Discussion and Analysis**  
**Year ended December 31, 2022**

tax increment revenues and interest earnings due to the increased interest rate environment. In addition, there was a decrease in transfers out of \$30.7 million when compared to 2021, attributed to the timing and funding of eligible tax increment projects.

The Redevelopment District Tax Increment Capital Project Fund ended the year with a \$200.6 million fund balance (as compared to \$75.0 million in 2021), which was restricted for capital projects. The fund balance for the Redevelopment District Tax Increment Capital Project Fund increased by \$125.6 million, mainly due to the issuance of bonds for \$112.5 million related to the Elanco project, where bond proceeds will be used to acquire, construct, and equip facilities related to Elanco US, Inc., redevelopment and operation of a new global headquarters in the City, and related infrastructure improvements located on approximately 39 acres of a larger 91 acre site, commonly known as the former GM Stamping Plant.

**Governmental Funds – Fund Balances**  
*(In thousands)*

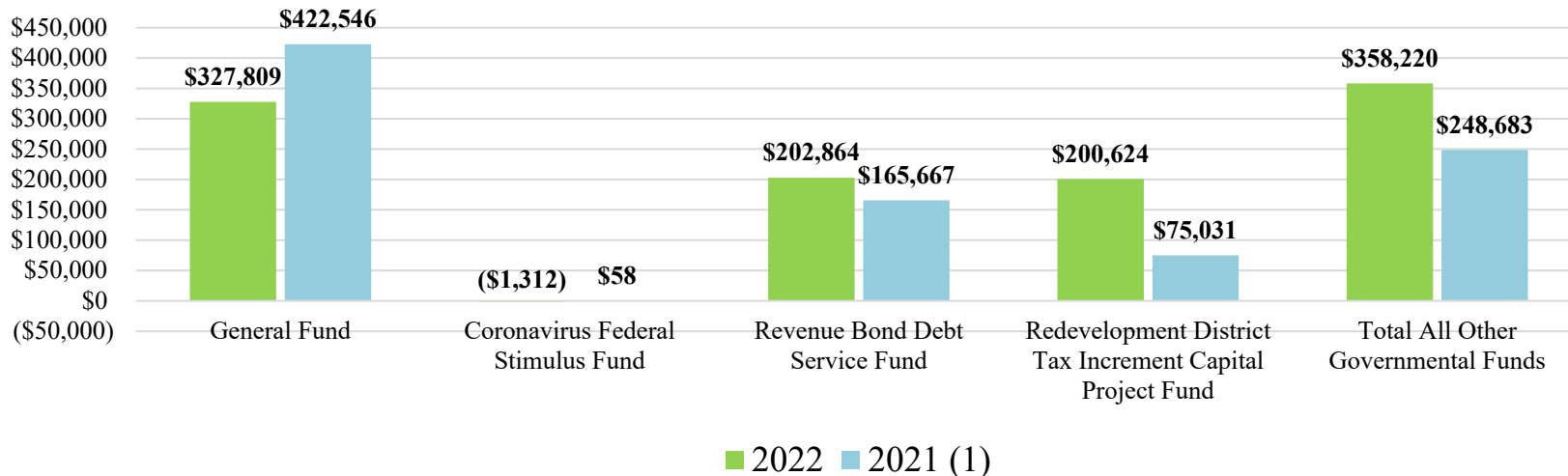

(1) The balances for the year ended December 31, 2021 have not been restated to reflect the adoption of GASB Statement No. 87, *Leases*. See Note 1 for additional information regarding adoption of this standard.

**CITY OF INDIANAPOLIS**  
**(A Component Unit of the Consolidated City of Indianapolis – Marion County)**  
**Management’s Discussion and Analysis**  
**Year ended December 31, 2022**

**Fiduciary Funds**

The City maintains fiduciary funds for the assets of the pension trust funds for police and firefighters hired before May 1, 1977. At the end of 2022, the net position of these pension funds amounted to \$1.6 million, which represents an increase of \$2.5 million in total net position during the year. Effective January 1, 2009, all pension payments are funded by the State of Indiana for the Pre-1977 pension plans. No further funding is required by the City.

The PERF and 1977 Police and Fire Plan net pension liabilities (assets) listed below are not a part of the fiduciary funds but are included in governmental activities.



**CITY OF INDIANAPOLIS**  
**(A Component Unit of the Consolidated City of Indianapolis – Marion County)**  
**Management’s Discussion and Analysis**  
**Year ended December 31, 2022**

The City is the custodian of certain custodial funds, and the most common use of custodial funds is for pass-through activity. At the end of 2022, the net position of the custodial funds was \$6.2 million. At the end of 2022, the combined gross assets of the custodial funds totaled \$7.3 million (\$8.4 million in 2021). This amount is composed of activity from the following custodial funds: Sanitation 15 Year Law, E-911 Allocation, Police and Fire Retiree Health Insurance, Indianapolis Metropolitan Police Department Confiscated Cash, and Other.

**General Fund Budgetary Highlights**

The final budget for the City’s General Fund represents the original budget plus any adjustments to appropriations during the year. It does not include encumbrances carried over from the prior year. In 2022, there was a \$34.2 million increase in appropriations during the year to the original General Fund budget, or an increase of 5%.

Excluding prior year encumbrances, the original General Fund expenditures budget for 2022 was \$709.3 million. The final General Fund expenditures budget was \$743.5 million. Actual expenditures were \$732.8 million. The total \$10.7 million underspent from the final budget were due to planned reductions in the budget, that were achieved through budget reserves and general operational savings.

General revenues were originally estimated at \$674.0 million, final estimated at \$693.0 million, and the actual was \$690.1 million, which was \$2.9 million lower than budgeted. Overall, we saw \$7.3 million lower than budgeted in intragovernmental revenues, due to the timing of reimbursements related to infrastructure capital projects with the Indianapolis Public Transportation Corporation (“IndyGo”) and other intergovernmental units. We saw an increase of \$6.7 million in taxes, which is attributable to our conservative budgeting of taxes. In addition, we had a \$1.7 million increase in intergovernmental revenues related to increases in gas tax distributions.

Actual expenditures were greater than revenues by \$42.7 million. However, if other financing sources are taken into account, the net of revenues plus transfers is less than expenditures by \$31.5 million. The majority of the excess of expenditures over revenues and other financing sources can be attributed to a \$40 million transfer out to the nonmajor Capital Asset and Lifecycle Development Fund, for further investment in thoroughfare and residential road infrastructure. This was a one-time planned spend down of excess fund balance.



**CITY OF INDIANAPOLIS**  
**(A Component Unit of the Consolidated City of Indianapolis – Marion County)**  
**Management’s Discussion and Analysis**  
**Year ended December 31, 2022**

**CAPITAL and LEASE ASSETS, AND DEBT ADMINISTRATION**

**Capital and Lease Assets**

The City had a net investment of \$1.81 billion in capital and lease assets at December 31, 2022 (net of accumulated depreciation and amortization of \$3.28 billion) in a broad range of capital and lease assets. This amount represents a net increase for the current year (including additions and deductions) of \$140.7 million.

**Schedule of Capital and Lease Assets**  
*(In thousands)*

	<b>Governmental activities 2022</b>	<b>Governmental activities 2021 (1)</b>
Land	\$ 94,198	\$ 87,693
Construction in progress	526,832	390,598
Buildings	201,228	192,832
Improvements	120,111	125,716
Equipment	101,927	94,140
Infrastructure	762,263	774,900
Total	<u>\$ 1,806,559</u>	<u>\$ 1,665,879</u>

(1) The balances for the year ended December 31, 2021 have not been restated to reflect the adoption of GASB Statement No. 87, *Leases*. See Note 1 for additional information regarding adoption of this standard.

**2022 Capital and Lease Assets**

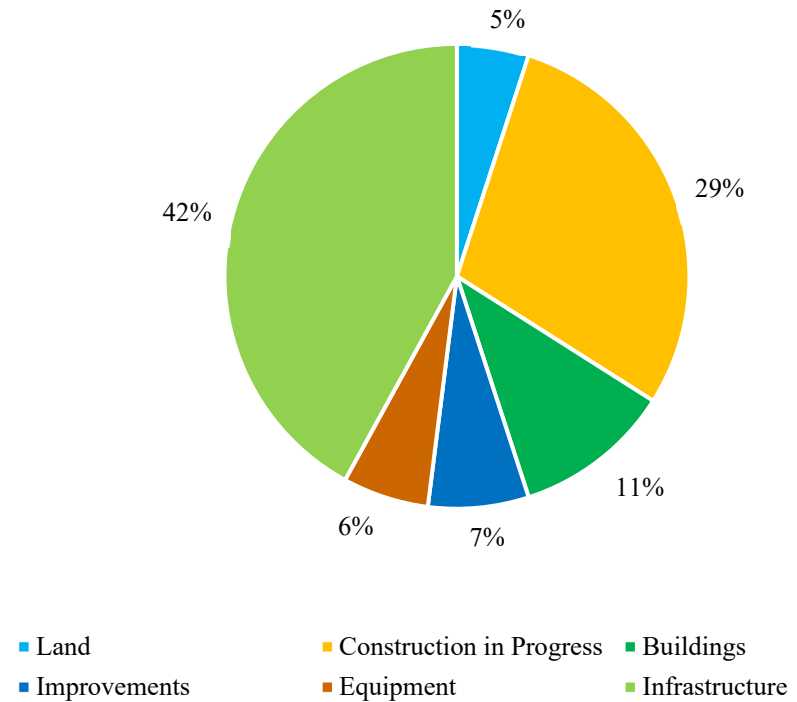

**CITY OF INDIANAPOLIS**  
**(A Component Unit of the Consolidated City of Indianapolis – Marion County)**  
**Management’s Discussion and Analysis**  
**Year ended December 31, 2022**

Major capital and lease asset additions in 2022 for governmental activities included:

- \$267.9 million of additions to construction in progress, principally infrastructure, and improvements. Reductions to construction in progress were \$131.3 million, of which \$115.5 million was transferred into infrastructure and \$9.6 into buildings.
- \$13.5 million of additions to buildings, principally related to the Indianapolis Fire Department’s Training Facility.
- \$2.8 million of additions to improvements, principally upgrades at parks and recreation facilities.
- \$11.3 million of additions to equipment, principally for public safety and public works vehicles.
- \$121.8 million of additions to infrastructure, principally \$21.8 million for storm sewers, \$86.7 million for streets, curbs, and sidewalks, and \$13.3 million for bridges.
- \$6.5 million of additions to land, principally related to parks projects.

Donated capital assets for governmental activities were \$5.8 million, mainly attributable to capital contributions from the State of Indiana for public works projects built on the City’s behalf. Depreciation and amortization expense for 2022 for governmental activities was \$148.2 million. At December 31, 2022, the City had commitments related to ongoing capital asset construction projects of \$122.8 million. See footnote 9 to the basic financial statements for more information regarding capital and lease assets.

**CITY OF INDIANAPOLIS**  
**(A Component Unit of the Consolidated City of Indianapolis – Marion County)**  
**Management’s Discussion and Analysis**  
**Year ended December 31, 2022**

**Long-Term Obligations**

At the end of 2022, the City had outstanding long-term debt and other long-term obligations for governmental activities of \$2.58 billion, compared to \$2.45 billion at December 31, 2021 as shown below:

**Schedule of Long-Term Debt and Other Obligations**  
*(In thousands)*

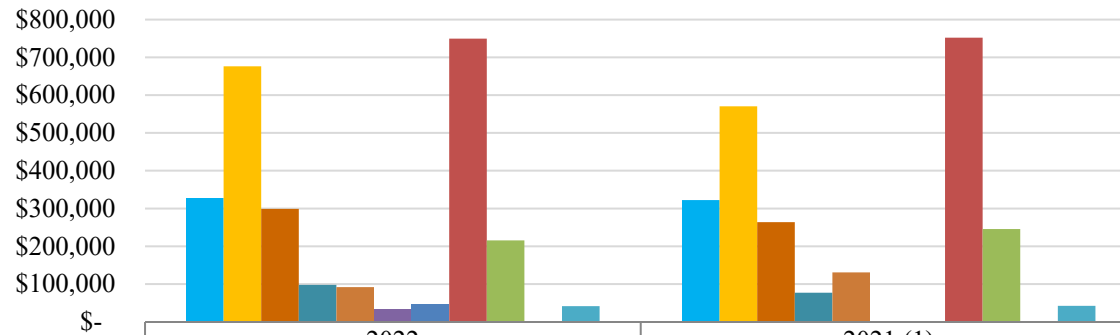

	2022	2021 (1)
Serial bonds payable	\$327,760	\$322,285
Tax increment bonds payable	\$676,206	\$570,423
Revenue bonds payable	\$298,870	\$263,715
Deferred premiums	\$97,674	\$77,286
Notes payable and certificates of participation	\$91,905	\$130,723
Financed purchase obligations *	\$31,929	\$-
Lease liabilities *	\$46,131	\$-
Net pension liabilities	\$749,728	\$752,245
Postemployment benefit obligation	\$215,784	\$245,607
Early retirement obligation	\$-	\$1,622
Compensated absences	\$41,428	\$42,564

(1) The balances for the year ended December 31, 2021 have not been restated to reflect the adoption of GASB Statement No. 87, *Leases*. See Note 1 for additional information regarding adoption of this standard.

**CITY OF INDIANAPOLIS**  
**(A Component Unit of the Consolidated City of Indianapolis – Marion County)**  
**Management’s Discussion and Analysis**  
**Year ended December 31, 2022**

The chart below demonstrates that, for the pension plans that must be funded by the City and not the State of Indiana, the City’s percentage of funded status slightly increased for the PERF plan and slightly decreased for the 1977 Police and Fire pension plans from 2021 to 2022.

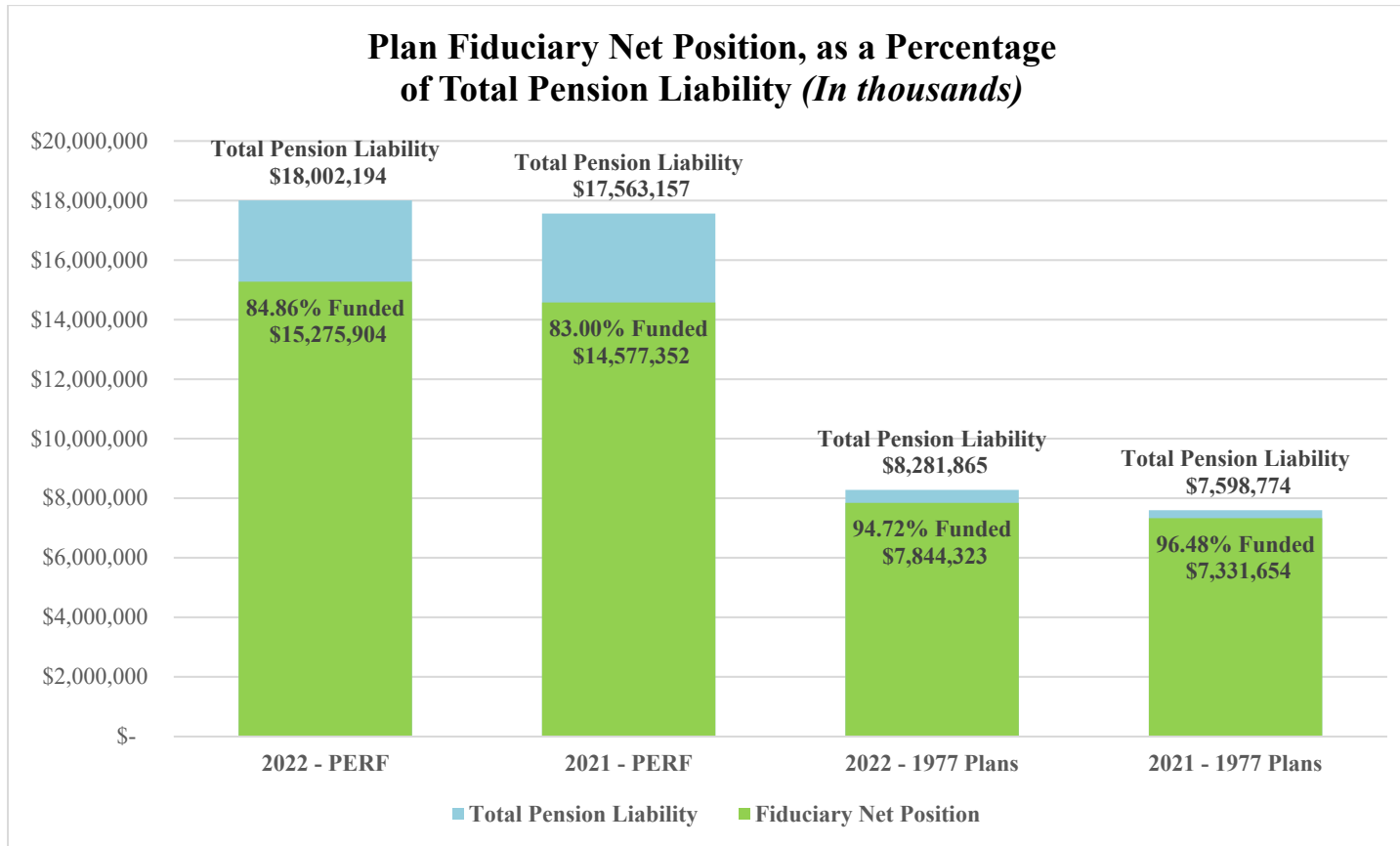

The decrease in the postemployment benefit obligation on the previous page relates to changes in actuarial assumptions. The City continues to fund this on a pay-as-you-go-basis, as contractually required in the union collective bargaining agreements.

**CITY OF INDIANAPOLIS**  
**(A Component Unit of the Consolidated City of Indianapolis – Marion County)**  
**Management’s Discussion and Analysis**  
**Year ended December 31, 2022**

**Bonds and Notes Issued**

**General Obligation Bonds**

On December 15, 2022, the City issued its Consolidated Civil City Bonds, Series 2022A in the amount of \$11.5 million. The proceeds will be used for the acquisition, design, planning, enabling work, site-work, construction, installation, equipping and/or financing of all or a portion of the following projects: a new fire station for Ladder 20 and related improvements, necessary repair and renovation of numerous Indianapolis Fire Department stations, and sidewalks, road and streetscapes, a pavilion or other public infrastructure, landscaping, and all related work necessary to complete the improvements at or near to Dr. Martin Luther King Jr. Park. The bonds mature on January 15, 2043 and have an interest rate of 5.25%-5.50%.

On December 15, 2022, the City issued its Consolidated Civil City Bonds, Taxable Series 2022B in the amount of \$12.0 million. The proceeds will be used for repair, replacement and enhancement of City Market infrastructure including work to the market house, west plaza, and Wabash Alley. The bonds mature on January 15, 2035 and have an interest rate of 4.798%-5.337%.

**Tax Increment Revenue Bonds**

On February 24, 2022, the City issued its Economic Development Tax Increment Revenue Bonds, Series 2022B (Elanco) in the amount of \$112.5 million. The proceeds will be used to acquire, construct, and equip facilities related to Elanco US, Inc., redevelopment and operation of a new global headquarters in the City, and related infrastructure improvements located on approximately 39 acres of a larger 91 acre site, commonly known as the former GM Stamping Plant. The proceeds will also affect a current refunding on the Indianapolis Local Improvement Bond Bank’s Series 2011 F bonds. While the refunding was not completed at the qualified entity level, the savings related to the refunding will be passed along to the City. The bonds mature on February 1, 2047 and have interest rates of 4.00%-5.00%.

On June 30, 2022, the City issued its Economic Development Tax Increment Revenue Bonds, Series 2022 D (16 Tech Project) in the amount of \$19.5 million. The proceeds will be used to pay for the costs of construction of the 16 Tech Project, and pay all costs incidental to, or on account of the issuance of the 2022 Bonds. The proceeds will also be placed into a debt service reserve fund. The bonds mature on February 1, 2039 and have an interest rate of 3.77%.

On November 3, 2022, the City issued its Redevelopment District Refunding Bonds, Series 2022A in an amount of \$26.2 million. The proceeds will be used to effectuate a current refunding of the Redevelopment District Tax Increment Refunding Bonds of 2013, Series A and the Redevelopment District Tax Increment Bonds of 2013, Series A. The refunding resulted in an accounting gain of \$1.6 million, which has been deferred and is being amortized over the life of the bonds. As a result of the refunding, the City reduced its total debt service requirements by \$4.1 million, which resulted in an economic gain (the difference between the present values of the debt service payments on the old and new debt) of \$2.1 million. The bonds mature on February 1, 2030 and have an interest rate of 3.28%.

On November 3, 2022, the City issued its Economic Development Tax Increment Refunding Revenue Bonds, Series 2022B in an amount of \$16.4 million. The proceeds will be used to effectuate a current refunding of the Economic Development Tax Increment Revenue Bonds, Series 2013 A

**CITY OF INDIANAPOLIS**  
**(A Component Unit of the Consolidated City of Indianapolis – Marion County)**  
**Management’s Discussion and Analysis**  
**Year ended December 31, 2022**

and B. The refunding resulted in an accounting gain of \$1.0 million, which has been deferred and is being amortized over the life of the bonds. As a result of the refunding, the City reduced its total debt service requirements by \$2.0 million, which resulted in an economic gain (the difference between the present values of the debt service payments on the old and new debt) of \$1.5 million. The bonds mature on February 1, 2030 and have an interest rate of 3.28%.

**Developer Backed Bonds**

On February 1, 2022, the City issued its Economic Development Tax Increment Bonds, Series 2022 A (Indy Penn Center Hotel Garage Project), in the amount of \$18.2 million. The proceeds, together with a cash contribution, was used to redeem the City’s outstanding Economic Development Tax Increment Revenue Bond Anticipation Note, Series 2017, in the amount of \$17.9 million. The bonds mature on February 1, 2042 and have an interest rate of 2.31%.

On August 11, 2022, the City issued its Economic Development Tax Increment Revenue Bonds, Series 2022A (Federally Taxable – Stutz 1 Project) and its Economic Development Tax Increment Revenue Bonds, Series 2022B (Federally Taxable – Stutz 1 Project) in the amounts of \$9.0 million and \$3.3 million, respectively. The proceeds will be used to provide the Developer with funds to finance the redevelopment, construction, and equipping of the existing Stutz Factory Building into a mixed-use facility consisting of approximately 12,000 square feet of retail and dining space, approximately 27,000 square feet of coworking space, approximately 17,000 square feet of event space, and approximately 15,000 square feet of fitness/lifestyle space, located at 1060 North Capitol Avenue in the City. The bonds are draw bonds, and as of December 31, 2022 no draws have been made. The interest rate for these bonds is 6.50%.

**Revenue Bonds**

On February 24, 2022, the City issued its Stormwater District Revenue Bonds, Series 2022A in the amount of \$50.0 million. The proceeds will be used to effect a current refunding of the Stormwater District Revenue Notes, Series 2019, pay for all or a portion of the costs of certain additions and improvements to the Stormwater District’s Stormwater System, and pay all costs incidental to, or on account of the issuance of the 2022 Bonds. The bonds mature on January 1, 2052 and have interest rates of 4.00%-5.00%.

**Note Payable**

On February 15, 2022, the City executed a public-private build-operate-transfer agreement with Garmong & Son, Inc. in amount not to exceed \$36.1 million for the design, construction and financing of a judicial and professional building parking garage, located at the Community Justice Campus. The installment purchase agreement matures on January 30, 2027 and has a balloon principal payment of \$33.0 million due on that date, interest is due annually at a rate of 1.9%. The outstanding balance at December 31, 2022 is \$25.4 million, which represents the cost of the construction for the garages as of year-end.

**CITY OF INDIANAPOLIS**  
**(A Component Unit of the Consolidated City of Indianapolis – Marion County)**  
**Management’s Discussion and Analysis**  
**Year ended December 31, 2022**

**Lease Liabilities and Financed Purchase Obligations**

During 2022, the City implemented GASB Statement No. 87, Leases (GASB No. 87). This statement requires governments to recognize certain lease assets and liabilities for leases that previously were classified as operating leases and recognize as inflows of resources or outflows of resources based on the payment provisions of the contract. As of December 31, 2022 the City has recorded a long-term lease liability of \$46,131.

On July 13, 2022, the City entered into a financed purchase obligation with JP Morgan Chase Bank in the amount of \$10,283. The proceeds will be used to purchase pursuit vehicles for the police department. The outstanding balance at December 31, 2022 is \$9,456 and matures on June 1, 2028. The stated interest rate is 2.56%. At December 31, 2022, the City has recorded \$10,275 of cash in escrow related to the financed purchase obligation.

On November 18, 2022, the City entered into a financed purchase obligation with JP Morgan Chase Bank in the amount of \$22,473. The proceeds were used to purchase fire apparatus vehicles for the fire department. The stated interest rate is 3.62%. The outstanding balance at December 31, 2022 is \$22,473 and matures on September 1, 2030.

**Bond ratings.** The City’s general obligation bonds are rated AA+ by Standards & Poor’s, AAA by Fitch, Aaa by Moody’s, and AAA by Kroll. The City’s other debt, principally revenue bonds and notes, are rated to reflect the creditworthiness of the supporting revenue.

**Limitations on debt.** The state limits the amount of general obligation debt the City can issue to varying percentages of assessed value, by taxing district, as shown in the statistical section. The City’s outstanding debt is well below the limit in each case.

See footnote 11 to the basic financial statements for more information regarding long-term debt.

**ECONOMIC FACTORS AND THE 2023 BUDGET**

The 2023 original budget for all annually council appropriated funds was \$1.027 billion. Revisions of \$107.1 million have been made through May 2023. Revisions primarily relate to the following:

- \$81.6 million was appropriated in the Capital Asset Lifecycle and Development fund, of which \$74.1 million is to finance design, construction, and inspection costs of parks from a grant award from the Lilly Foundation and \$7.5 million is to fund additional transportation projects.
- \$15.1 million were appropriated in the Consolidated County Cumulative Capital Development fund with the purpose of funding debt service reserve and revenue stabilization funds for a new debt issuance, and to fund capital project cost increases due to inflation.
- \$3.0 million was appropriated in the Federal Grants fund for additional parks projects.
- \$2.6 million was appropriated in the Redevelopment General fund to create affordable housing by investing in housing projects.
- \$1.6 million was appropriated in the Opioid Settlement fund for use by various City-County departments and agencies to continue and expand the comprehensive Anti-Violence Plan.

**CITY OF INDIANAPOLIS**  
**(A Component Unit of the Consolidated City of Indianapolis – Marion County)**  
**Management’s Discussion and Analysis**  
**Year ended December 31, 2022**

The 2023 General Fund original budget was \$714.5 million, an increase of 0.7% from the 2022 General Fund original budget of \$709.3 million. Revisions of \$4.3 million have been made through May 2023.

Unemployment rates were as follows:

	April 2023	April 2022
City of Indianapolis	2.4%	2.0%
State of Indiana	3.0%	2.2%
United States	3.4%	3.6%

Source: United States Department of Labor, [www.bls.gov](http://www.bls.gov)

**REQUESTS FOR INFORMATION**

This financial report is designed to provide citizens, taxpayers, customers, investors, and creditors with a general overview of the City’s finances and to demonstrate the City’s accountability for the money it receives. If you have any questions about this report or need additional information, please contact the City of Indianapolis, Office of Finance and Management, 200 East Washington Street, Suite 2222, Indianapolis, Indiana 46204.



## Basic Financial Statements

# Basic Financial Statements

**CITY OF INDIANAPOLIS**  
**(A Component Unit of the Consolidated City of Indianapolis - Marion County)**  
**Statement of Net Position**  
December 31, 2022  
*(In thousands)*

	<b>Primary Government</b>	<b>Component Unit</b>
	<b>Governmental activities</b>	<b>Indianapolis Housing Agency</b>
<b>ASSETS AND DEFERRED OUTFLOWS OF RESOURCES</b>		
<b>Assets:</b>		
Equity in pooled cash	\$ 44,041	\$ 11,388
Cash and investments with fiscal agents	374,462	17,920
Investments	1,046,131	—
Property taxes receivable	8,374	—
Accounts receivable, less allowance for uncollectibles	37,979	2,653
Due from federal and state governments	22,318	2,221
Lease receivable	—	804
Other assets	—	840
Long-term receivables, less allowance for uncollectibles	57,165	11,183
Capital assets:		
Land	94,198	21,256
Infrastructure, net of accumulated depreciation	762,263	—
Other capital assets, net of accumulated depreciation	373,709	129,122
Construction in progress	526,832	—
Lease assets, net of accumulated amortization	49,557	15
Total assets	3,397,029	197,402
<b>Deferred outflows of resources:</b>		
OPEB	24,987	—
Pensions	218,440	833
Losses on Refundings	20,501	—
Total deferred outflows of resources	263,928	833
Total assets and deferred outflows of resources	3,660,957	198,235

(Continued)

**CITY OF INDIANAPOLIS**  
**(A Component Unit of the Consolidated City of Indianapolis - Marion County)**  
**Statement of Net Position**  
December 31, 2022  
*(In thousands)*

	Primary Government	Component Unit
	Governmental activities	Indianapolis Housing Agency
<b>LIABILITIES AND DEFERRED INFLOWS OF RESOURCES</b>		
<b>Liabilities:</b>		
Accounts payable and other current liabilities	\$ 137,630	\$ 5,623
Accrued interest payable	12,229	—
Unearned revenue	331,857	1,206
Customer deposits	—	433
Other liabilities	—	1,537
Long-term liabilities:		
Due within one year	124,283	5,255
Due in more than one year	2,453,132	16,574
Total liabilities	3,059,131	30,628
<b>Deferred inflows of resources:</b>		
OPEB	79,884	—
Pensions	20,981	704
Parking meter concession agreement	15,200	—
Leases	—	817
Total deferred inflows of resources	116,065	1,521
Total liabilities and deferred inflows of resources	3,175,196	32,149
<b>NET POSITION (DEFICIT)</b>		
Net investment in capital assets	973,164	129,122
Restricted for:		
Capital projects	55,322	—
Debt service	257,835	—
Section 8 vouchers and VASH	—	5,341
Reserves and escrow	—	11,321
Programs	—	2,378
Other purposes by grantors	2,123	—
Other purposes by contributor – nonexpendable	376	—
Future opioid remediation efforts	17,342	—
Statutory restrictions	100,237	—
Unrestricted (deficit)	(920,638)	17,924
Total net position	\$ 485,761	\$ 166,086

The accompanying notes are an integral part of the financial statements.

**CITY OF INDIANAPOLIS**  
**(A Component Unit of the Consolidated City of Indianapolis - Marion County)**  
**Statement of Activities**  
Year ended December 31, 2022  
*(In thousands)*

<b>Functions/Programs</b>	<b>Expenses</b>	<b>Program revenues</b>			<b>Net (expense) revenue and changes in net position</b>	
		<b>Charges for services</b>	<b>Operating grants and contributions</b>	<b>Capital grants and contributions</b>	<b>Primary Government Governmental activities</b>	<b>Component Unit Indianapolis Housing Agency</b>
Governmental activities:						
General government	\$ 144,690	\$ 13,891	\$ 22,203	\$ —	\$ (108,596)	\$ —
Public safety	427,683	29,090	72,169	1,995	(324,429)	—
Public works	268,945	66,152	83,755	5,163	(113,875)	—
Health and welfare	21,141	59	160,977	—	139,895	—
Cultural and recreation	33,593	4,261	71,448	1,995	44,111	—
Urban redevelopment and housing	63,483	2,208	17,007	926	(43,342)	—
Economic development and assistance	30,375	1,779	3,474	—	(25,122)	—
Interest	56,702	—	—	—	(56,702)	—
Total governmental activities	<u>\$ 1,046,612</u>	<u>\$ 117,440</u>	<u>\$ 431,033</u>	<u>\$ 10,079</u>	<u>(488,060)</u>	<u>—</u>
<b>Component Unit</b>						
Indianapolis Housing Agency	\$ 86,222	\$ 8,555	\$ 61,922	\$ 3,098		(12,647)
Total component units	<u>\$ 86,222</u>	<u>\$ 8,555</u>	<u>\$ 61,922</u>	<u>\$ 3,098</u>		<u>(12,647)</u>
General revenues:						
Taxes:						
Property taxes					372,310	—
Wheel taxes					15,623	—
Local income taxes					297,989	—
Other taxes					27,204	—
Grants and contributions not restricted to specific program:					10,573	—
Investment earnings not restricted to specific program:					22,828	—
Miscellaneous					34,841	2,733
Total general revenues					<u>781,368</u>	<u>2,733</u>
Change in net position					<u>293,308</u>	<u>(9,914)</u>
Net position (deficit) – beginning of year, as previously reported					<u>174,630</u>	<u>176,000</u>
Change in accounting principle					<u>17,823</u>	<u>—</u>
Net position (deficit), beginning of year, as restated					<u>192,453</u>	<u>176,000</u>
Net position – ending					<u>\$ 485,761</u>	<u>\$ 166,086</u>

The accompanying notes are an integral part of the financial statements.

**CITY OF INDIANAPOLIS**  
**(A Component Unit of the Consolidated City of Indianapolis - Marion County)**  
**Balance Sheet – Governmental Funds**  
December 31, 2022  
*(In thousands)*

	<u>General</u>	<u>Coronavirus Federal Stimulus</u>	<u>Revenue Bond Debt Service</u>	<u>Redevelopment District Tax Increment Capital Project</u>	<u>Nonmajor Governmental Funds</u>	<u>Total Governmental Funds</u>
<b>ASSETS</b>						
Equity in pooled cash	\$ 19,608	\$ —	\$ 3,716	\$ 3,625	\$ 15,353	\$ 42,302
Cash and investments with fiscal agents	4,555	—	157,393	136,227	75,548	373,723
Investments	331,331	308,683	47,587	46,410	289,860	1,023,871
Property taxes receivable	7,316	—	—	—	1,058	8,374
Accounts receivable, less allowance of \$1,520	33,391	160	—	240	1,739	35,530
Due from other funds	14,775	—	—	—	—	14,775
Due from federal and state governments	5	1,678	—	—	20,635	22,318
Lease receivable	546	—	—	—	—	546
Long-term receivables, less allowance of \$25,840	100	—	—	18,020	39,045	57,165
Total assets	<u>\$ 411,627</u>	<u>\$ 310,521</u>	<u>\$ 208,696</u>	<u>\$ 204,522</u>	<u>\$ 443,238</u>	<u>\$ 1,578,604</u>
<b>LIABILITIES, DEFERRED INFLOWS OF RESOURCES AND FUND BALANCES</b>						
<b>Liabilities:</b>						
Matured bonds and notes payable	\$ —	\$ —	\$ 5,515	\$ —	\$ 7,642	\$ 13,157
Matured interest payable	—	—	317	—	2,666	2,983
Accounts payable and other accrued liabilities	50,951	12,434	—	3,898	26,277	93,560
Accrued payroll and payroll taxes	16,838	—	—	—	109	16,947
Due to other funds	—	—	—	—	14,775	14,775
Unearned revenue	296	297,721	—	—	783	298,800
Total liabilities	<u>68,085</u>	<u>310,155</u>	<u>5,832</u>	<u>3,898</u>	<u>52,252</u>	<u>440,222</u>
<b>Deferred inflows of resources</b>	<u>15,733</u>	<u>1,678</u>	<u>—</u>	<u>—</u>	<u>32,766</u>	<u>50,177</u>
<b>Fund balances:</b>						
Nonspendable	—	—	—	—	376	376
Restricted	91,746	—	202,864	200,624	306,571	801,805
Committed	12,273	—	—	—	60,225	72,498
Assigned	105,202	—	—	—	—	105,202
Unassigned	118,588	(1,312)	—	—	(8,952)	108,324
Total fund balances	<u>327,809</u>	<u>(1,312)</u>	<u>202,864</u>	<u>200,624</u>	<u>358,220</u>	<u>1,088,205</u>
Total liabilities, deferred inflows of resources and fund balances	<u>\$ 411,627</u>	<u>\$ 310,521</u>	<u>\$ 208,696</u>	<u>\$ 204,522</u>	<u>\$ 443,238</u>	<u>\$ 1,578,604</u>

The accompanying notes are an integral part of the financial statements.

**CITY OF INDIANAPOLIS**  
**(A Component Unit of the Consolidated City of Indianapolis - Marion County)**  
**Reconciliation of the Balance Sheet for Governmental Funds**  
**to the Statement of Net Position**  
December 31, 2022  
*(In thousands)*

Fund balances – total governmental funds	\$ 1,088,205
Amounts reported for governmental activities in the statement of net position are different because:	
Capital assets not reported in the fund statements	1,757,002
Right to use assets not reported in the fund statements	49,557
Net position of internal service funds not recorded in the fund statements	3,771
Deferred outflows of resources - OPEB not recorded in the fund statements	24,987
Deferred outflows of resources - pensions not recorded in the fund statements	218,440
Deferred outflows of resources - loss on refundings not recorded in the fund statements	20,501
Deferred inflows of resources - parking meter concession agreement not recorded in the fund statements	(15,200)
Deferred inflows of resources - OPEB not recorded in the fund statements	(79,884)
Deferred inflows of resources - pensions not recorded in the fund statements	(20,981)
Long-term liabilities not in the fund statements (excludes matured bonds payable of \$13,157)	(2,564,258)
Other liabilities not in the fund statements	(3,707)
Deferred inflows of resources in the fund statements not in the statement of net position	49,631
Unearned revenue in the statement of net position not in the fund statements	(33,057)
Accrued interest payable not in the fund statements (excludes matured interest payable)	<u>(9,246)</u>
Net position of governmental activities	<u>\$ 485,761</u>

The accompanying notes are an integral part of the financial statements.

**CITY OF INDIANAPOLIS**  
**(A Component Unit of the Consolidated City of Indianapolis - Marion County)**  
**Statement of Revenues, Expenditures, and Changes in Fund Balances – Governmental Funds**  
Year ended December 31, 2022  
*(In thousands)*

	General	Coronavirus Federal Stimulus	Revenue Bond Debt Service	Redevelopment District Tax Increment Capital Project	Nonmajor Governmental Funds	Total Governmental Funds
Revenues:						
Taxes	\$ 479,181	\$ —	\$ 116,692	\$ —	\$ 117,337	\$ 713,210
Licenses and permits	17,770	—	—	—	—	17,770
Charges for services	80,998	—	—	—	3,149	84,147
Other intergovernmental revenues:						
Federal revenues	3,752	141,903	—	—	45,384	191,039
State revenues	134,892	—	—	—	4,197	139,089
Other revenues	6,457	—	—	588	1,000	8,045
Intragovernmental revenues	8,047	—	—	—	—	8,047
Traffic violations and court fees	2,030	—	—	—	4,575	6,605
Interest and other operating revenues	19,227	5,575	4,323	7,587	105,923	142,635
Total revenues	<u>752,354</u>	<u>147,478</u>	<u>121,015</u>	<u>8,175</u>	<u>281,565</u>	<u>1,310,587</u>
Expenditures:						
Current:						
General government	103,584	53,652	310	—	2,791	160,337
Public safety	516,388	34,619	—	—	10,419	561,426
Public works	125,219	643	—	—	1,240	127,102
Health and welfare	3,221	1,014	—	—	16,952	21,187
Cultural and recreation	28,032	48	—	—	789	28,869
Urban redevelopment and housing	6,449	38,865	—	—	13,076	58,390
Economic development and assistance	2,061	3,092	8,000	8,422	5,561	27,136
Debt service:						
Redemption of bonds, notes and financed purchase obligations	1,704	—	52,388	—	149,984	204,076
Interest on bonds and notes	282	—	5,706	—	40,867	46,855
Bond and note issuance costs	1,548	—	189	1,382	1,687	4,806
Lease payments and other	4,208	—	378	2	16,052	20,640
Capital outlays	73,260	16,915	—	26,486	135,595	252,256
Total expenditures	<u>865,956</u>	<u>148,848</u>	<u>66,971</u>	<u>36,292</u>	<u>395,013</u>	<u>1,513,080</u>
Excess (deficiency) of revenues over (under) expenditures	<u>(113,602)</u>	<u>(1,370)</u>	<u>54,044</u>	<u>(28,117)</u>	<u>(113,448)</u>	<u>(202,493)</u>

(Continued)



**CITY OF INDIANAPOLIS**  
**(A Component Unit of the Consolidated City of Indianapolis - Marion County)**  
**Statement of Revenues, Expenditures, and Changes in Fund Balances – Governmental Funds**  
Year ended December 31, 2022  
*(In thousands)*

	<u>General</u>	<u>Coronavirus Federal Stimulus</u>	<u>Revenue Bond Debt Service</u>	<u>Redevelopment District Tax Increment Capital Project</u>	<u>Nonmajor Governmental Funds</u>	<u>Total Governmental Funds</u>
Other financing sources (uses):						
Incurrence of lease liabilities	\$ 8,346	\$ —	\$ —	\$ —	\$ —	\$ 8,346
Sales of capital assets	1,495	—	—	—	—	1,495
Bonds, notes and financed purchase obligations issued	—	—	—	135,111	159,248	294,359
Premium on bonds and notes issued	—	—	—	20,708	11,265	31,973
Refunding bonds issued	—	—	18,430	—	24,110	42,540
Transfers in	72,677	—	17,796	20,954	166,373	277,800
Transfers out	(63,653)	—	(53,073)	(23,063)	(138,011)	(277,800)
Total other financing sources (uses)	<u>18,865</u>	<u>—</u>	<u>(16,847)</u>	<u>153,710</u>	<u>222,985</u>	<u>378,713</u>
Net change in fund balances	(94,737)	(1,370)	37,197	125,593	109,537	176,220
Fund balances at beginning of year	<u>422,546</u>	<u>58</u>	<u>165,667</u>	<u>75,031</u>	<u>248,683</u>	<u>911,985</u>
Fund balances at end of year	<u>\$ 327,809</u>	<u>\$ (1,312)</u>	<u>\$ 202,864</u>	<u>\$ 200,624</u>	<u>\$ 358,220</u>	<u>\$ 1,088,205</u>

The accompanying notes are an integral part of the financial statements.

**CITY OF INDIANAPOLIS**  
**(A Component Unit of the Consolidated City of Indianapolis - Marion County)**  
**Reconciliation of the Statement of Revenues, Expenditures and Changes in Fund Balances**  
**of Governmental Funds to the Statement of Activities**  
Year ended December 31, 2022  
*(In thousands)*

Net change in fund balances – total governmental funds	\$ 176,220
Amounts reported for governmental activities in the statement of activities are different because:	
Depreciation expense reported in the statement of activities but not in the fund statements	(142,254)
Amortization expense reported in the statement of activities but not in the fund statements	(5,952)
Capital outlay expenditures, exceeding capitalization threshold, reported in the fund statements but reported as additions to capital assets in the statement of net position	249,372
Donations of capital assets not recorded in the fund statements	(185)
Loss on disposals of capital assets not recorded in the fund statements	(3,572)
Revenues in the statement of activities that do not provide current financial resources and are deferred inflows in the fund statements	49,631
Revenues in the fund statements but not in the current year statement of activities due to the current financial resources focus of the governmental funds	(36,512)
Remediation settlement expenditures recorded in the fund statements but reported as a reduction in a liability in the statement of net position	50
Bond and notes issued, including premiums, reported as financing sources in the fund statements but as additions to long-term liabilities in the statement of activities	(368,872)
Incurrence of lease liabilities recorded as other financing sources in the fund statements but as an increase in long-term liabilities in the statement of net position	(8,346)
Bond, note and financed purchase obligation payments reported as expenditures in the fund statements but as reductions of long-term liabilities in the statement of net position	204,076
Lease liability payments reported as expenditures in the fund statements but as reduction of long-term liabilities in the statement of net position	9,378
Amortization of deferred inflows of resources related to the parking meter agreement reported as income in the statement of activities but not in the fund statements	400
Change in net position of internal service funds reported with governmental activities	(1,128)
Amortization of bond premium, discount, and loss on refunding reported in the statement of activities but not in the fund statements	6,720
Decrease in early retirement obligation that is not reported in the fund statements	1,622
Decrease in compensated absences that is not reported in the fund statements	1,136
Capital appreciation bond interest expense that is reported in the statement of activities but not the fund statements, as there is no cash outflow	(8,741)
Accrued interest on bonds and notes payable through December 31, 2022 reported as expenses in the statement of activities but not the fund statements, net of matured interest payable	(9,246)
Accrued interest at December 31, 2022 not reported in the current year statement of activities but reported in the fund statements, as amounts were paid in the current year	7,609
Net decrease in the other postemployment benefit liability that is not reported in the fund statements	(2,416)
Pension contributions recognized as expenditures in the fund statements in excess of pension expense recognized in the statement of activities	<u>174,318</u>
Change in net position of governmental activities	<u>\$ 293,308</u>

The accompanying notes are an integral part of the financial statements.

**CITY OF INDIANAPOLIS**  
**(A Component Unit of the Consolidated City of Indianapolis - Marion County)**  
**Statement of Net Position**  
**Proprietary Funds**  
December 31, 2022  
*(In thousands)*

		<b>Governmental activities – Internal Service Funds</b>
<b>ASSETS</b>		
Current assets:		
Equity in pooled cash	\$	1,739
Cash with fiscal agents		739
Investments		22,260
Accounts receivable		2,449
Total current assets		27,187
<b>LIABILITIES</b>		
Accounts payable and other current accrued liabilities		23,416
Total current liabilities		23,416
<b>NET POSITION</b>		
Unrestricted net position		3,771
Total net position	\$	3,771

The accompanying notes are an integral part of the financial statements.

**CITY OF INDIANAPOLIS**  
**(A Component Unit of the Consolidated City of Indianapolis - Marion County)**  
**Statement of Revenues, Expenses, and Changes in Fund Net Position**  
**Proprietary Funds**  
Year ended December 31, 2022  
*(In thousands)*

		<b>Governmental activities – Internal Service Funds</b>
		<u>                    </u>
Operating revenues:		
Charges to other funds	\$	115,979
Operating expenses:		
Claims		117,353
Administration		<u>227</u>
Total operating expenses		<u>117,580</u>
Operating loss		<u>(1,601)</u>
Nonoperating revenue:		
Investment income		<u>473</u>
Changes in net position		(1,128)
Net position, beginning of year		<u>4,899</u>
Net position, end of year	\$	<u><u>3,771</u></u>

The accompanying notes are an integral part of the financial statements.

**CITY OF INDIANAPOLIS**  
**(A Component Unit of the Consolidated City of Indianapolis - Marion County)**  
**Statement of Cash Flows**  
**Proprietary Funds**  
Year ended December 31, 2022  
*(In thousands)*

		<b>Governmental activities – Internal Service Funds</b>
Cash flows from operating activities:		
Receipts from users	\$	116,577
Payments for administration		(227)
Payments for claims		(116,421)
Net cash used in operating activities		(71)
Cash flows from investing activities:		
Sales and maturities of investments		(2,466)
Investment purchases		1,568
Investment income		473
Net cash used in investing activities		(425)
Net decrease in cash		(496)
Cash, beginning of year		2,974
Cash, end of year	\$	2,478
Reconciliation of operating loss to net cash (used) by operating activities:		
Operating loss	\$	(1,601)
Adjustments to reconcile operating loss to net cash used in operating activities:		
Change in assets and liabilities:		
Decrease (increase) in accounts receivable		598
Increase (decrease) in accounts payable		932
Net cash used by operating activities	\$	(71)

The accompanying notes are an integral part of the financial statements.

**CITY OF INDIANAPOLIS**  
**(A Component Unit of the Consolidated City of Indianapolis - Marion County)**  
**Fiduciary Funds**  
**Statement of Fiduciary Net Position**  
December 31, 2022  
*(In thousands)*

	<b>Pension (and Other Postemployment Benefit) Trust Funds</b>	<b>Custodial Funds</b>
<b>ASSETS</b>		
Equity in pooled cash	\$ 114	\$ 460
Investments		
Pooled investments	1,455	5,894
Accounts receivable	—	969
Total assets	1,569	7,323
<b>LIABILITIES</b>		
Accounts payable and other accrued liabilities	—	1,117
Due to other funds	—	—
Total liabilities	—	1,117
<b>NET POSITION</b>		
Restricted for:		
Pensions	1,569	—
Individuals, organization, and other governments	—	6,206
Total restricted net position	\$ 1,569	\$ 6,206

The accompanying notes are an integral part of the financial statements.

**CITY OF INDIANAPOLIS**  
**(A Component Unit of the Consolidated City of Indianapolis - Marion County)**  
**Fiduciary Funds**  
**Statement of Changes in Fiduciary Net Position**  
Year ended December 31, 2022  
*(In thousands)*

	<b>Pension (and Other Postemployment Benefit) Trust Funds</b>	<b>Custodial Funds</b>
<b>ADDITIONS</b>		
Employer contributions	\$ 55,269	\$ 2,709
Police confiscations	—	2,508
Fees collected for other governments	—	7,245
Total additions	55,269	12,462
<b>DEDUCTIONS</b>		
Benefits paid to participants or beneficiaries	52,734	2,709
Payments of fees collected to other governments	—	7,245
Court released confiscations	—	3,351
Total deductions	52,734	13,305
Net increase (decrease) in net position	2,535	(843)
Net position (deficit) – beginning of year	(966)	7,049
Net position – end of year	\$ 1,569	\$ 6,206

The accompanying notes are an integral part of the financial statements.

**CITY OF INDIANAPOLIS**  
**(A Component Unit of the Consolidated City of Indianapolis – Marion County)**  
Notes to Financial Statements  
December 31, 2022  
(Dollars in Thousands)

---

**1. Summary of Significant Accounting Policies**

**A. Reporting Entity**

The City of Indianapolis (“City”), located in Marion County, Indiana, was originally incorporated in 1832. On January 1, 1970, the government of the City, as defined by the Consolidated First-Class Cities and Counties Act, adopted by the 1969 Indiana General Assembly, and Marion County (“County”) were unified (“Consolidated City”). Their form of service delivery was consolidated and certain of the City’s service boundaries were extended to generally coincide with those of the County. Four other municipalities (Speedway, Lawrence, Southport, and Beech Grove) located within the County boundaries are specifically excluded from most functions of the Consolidated City by the consolidating act.

The City operates under an elected Mayor/City-County Council (25 members) form of government and provides the following services: public safety (police and fire), culture and recreation, community development and welfare (including planning and zoning), highways and streets, environmental service (solid waste collection and disposal), and general administrative services.

For financial reporting purposes, the City is considered to be a component unit of the Consolidated City of Indianapolis – Marion County Reporting Entity (unified government, commonly referred to as “Unigov”), as defined by Governmental Accounting Standards Board (“GASB”) Statement No. 14, *The Financial Reporting Entity*. The elected officials and the Mayor serve as the executive body for both the City and the County while the City-County Council (“Council”) serves as the legislative body for both the City and the County. The City is considered a legally separate organization for which its elected officials are financially accountable. This accountability is evidenced by the elected officials’ ability to: (a) approve the budget of the City; (b) veto, override, or modify the budget; and (c) establish tax levies. Additionally, the Mayor appoints the City’s deputy mayors and the City’s department directors subject to the approval of the Council, and also appoints the City Controller and Corporation Counsel.

**Component Units**

The City’s financial reporting entity has been determined in accordance with governmental accounting standards. The Indianapolis Housing Agency (“Housing Agency”) is responsible for the management, operation, maintenance, and administration of public housing and public housing projects, and the provision of safe, sanitary, and affordable dwelling accommodations for qualified persons of low and moderate income. The Housing Agency has a separate Board of Commissioners, which is comprised of nine members. The Mayor appoints five members while the Council appoints two members. The remaining two members are appointed from the Indianapolis Housing Agency Residents’ Council, one from the family housing community and one from the senior community. The Housing Agency has formed four wholly owned subsidiaries. The Housing Agency’s subsidiaries are the controlling general partners of limited partnerships formed to acquire, construct, and operate developments. The financial information of the limited partnerships is included in the financial reporting entity of the Housing Agency as blended component units. The Housing Agency is included as a discretely presented component unit of the City because it possesses the corporate powers that would distinguish it as being a legally separate entity and because the Mayor and Council appoint a voting majority of the Housing Agency’s governing body and can remove a board member at will.

The Housing Agency has established a nonprofit entity, Insight Development Corporation, Inc. (“Insight”) (formerly known as Partners for Affordable Housing, Inc.), which is legally separate from the Housing Agency, and which is exempt from federal income tax under Section 501(c)(3). The purpose of Insight is to foster low-income housing in and around Indianapolis. Insight has as its sole member the Housing Agency and its board consists of seven members, three of which are Housing Agency board members. Accordingly, Insight is considered to be a component unit of the Housing Agency and its financial information is included in the blended financial information herein reported for the Housing Agency. The Housing Agency and Insight issue separate financial statements, which can be obtained by writing to Indianapolis Housing Agency, 1919 North Meridian Street, Indianapolis, Indiana 46202.

The City’s financial reporting entity also includes the Circle Area Community Development Corporation (“CAC”), which was incorporated on July 22, 1997. The Mayor appoints the entire CAC board and may remove board members at will. The total outstanding debt of the CAC is expected to be repaid entirely with the resources of the City of Indianapolis and is therefore presented as a blended component unit. The CAC issues separate financial statements, which can be obtained by writing to Circle Area Community Development Corporation, 200 East Washington Street, Indianapolis, Indiana 46204.

**Related Organization**

The Mayor appoints the five members of the board of the Indianapolis Local Public Improvement Bond Bank (“Bond Bank”), but the City’s accountability for this organization does not extend beyond making such appointments.



**CITY OF INDIANAPOLIS**  
**(A Component Unit of the Consolidated City of Indianapolis – Marion County)**  
Notes to Financial Statements  
December 31, 2022  
(Dollars in Thousands)

---

**B. Government-Wide and Fund Financial Statements**

The government-wide financial statements (i.e., the statement of net position and the statement of activities) report information on all of the nonfiduciary activities of the City and its discretely presented component unit. *Governmental activities*, which normally are supported by taxes and intergovernmental revenues, are reported separately from *business-type activities*, which rely to a significant extent on fees and charges for support. However, the City currently has no business-type activities.

The statement of activities demonstrates the degree to which the direct expenses of a given function are offset by program revenues. *Direct expenses* are those that are clearly identifiable with a specific function. *Program revenues* include (1) charges to customers or applicants who purchase, use, or directly benefit from goods, services, or privileges provided by a given function and (2) grants and contributions that are restricted to meeting the operational or capital requirements of a particular function. Taxes and other items not properly included among program revenues are reported as *general revenues*.

Separate fund financial statements are provided for governmental funds, proprietary funds, and fiduciary funds, even though the latter are excluded from the government-wide financial statements. Major individual governmental funds are reported as separate columns in the fund financial statements.

**C. Measurement Focus, Basis of Accounting, and Financial Statement Presentation**

The government-wide financial statements are reported using the *economic resources measurement focus* and the *accrual basis of accounting*. Revenues are recorded when earned, and expenses are recorded when a liability is incurred, regardless of the timing of related cash flows. Property taxes are recognized in the period in which the tax levy and rates are certified, which is the period for which the taxes are levied. Grants and similar items are recognized as revenue as soon as all eligibility requirements imposed by the provider have been met.

Governmental fund financial statements are reported using the *current financial resources measurement focus* and the *modified accrual basis of accounting*. Under this basis of accounting, revenues are recognized as they become susceptible to accrual; generally, as soon as they are both measurable and available. Revenues are considered to be *available* when they are collected within the current period or soon enough thereafter to pay liabilities of the current period. For this purpose, the City considers property taxes to be available if they are collected and distributed within 60 days of the end of the current fiscal period. For all other revenue items, including taxes other than property taxes, the City considers revenue to be available if they are collected within 90 days of the end of the current fiscal period. Significant revenues susceptible to accrual include property and other taxes, grants, and interest on investments. Bonds and notes issued are recorded as other financing sources, along with any related premium or discounts.

Expenditures are generally recognized under the modified accrual basis of accounting when the related fund liability is incurred. Exceptions to this general rule include:

- 1) Debt service fund bond principal and interest expenditures due through January 15 are recorded on the preceding December 31. Expenditures related to compensated absences and claims and judgments are recorded only when payment is due (i.e., matured).
- 2) Prepaid expenditures are not recorded as an asset in the fund financial statements.

For financial reporting purposes, nonexchange transactions are grouped into the following four classes, based upon their principal characteristics: derived tax revenues, imposed nonexchange revenues, government-mandated nonexchange transactions, and voluntary nonexchange transactions.

The City recognizes assets from derived tax revenue transactions (such as local income tax) in the period when the underlying exchange transaction on which the tax is imposed occurs or when the resources are received, whichever occurs first. Revenues are recognized, net of estimated refunds and estimated uncollectible amounts, in the same period that the assets are recognized, provided that the underlying exchange transaction has occurred, and the resources are available. Resources received in advance in relation to derived tax revenue nonexchange transactions are reported as liabilities until the period of exchange.

The City recognizes assets from imposed nonexchange revenue transactions in the period when an enforceable legal claim to the resources arises or when the resources are received, whichever occurs first. Revenues are recognized in the period when the resources are required to be used or the first period that use is permitted. The City recognizes revenues from property taxes, net of estimated refunds and estimated uncollectible amounts, in the period in which the tax levy and rates are certified, which is the period for which the taxes are levied. Imposed nonexchange revenues also include taxes such as wheel, auto excise, and financial institutions.

Voluntary nonexchange transactions, such as grants and assistance received from other governmental units, and government-mandated nonexchange transactions are generally recognized as revenues in the period when all eligibility requirements have been met. For these types of transactions, resources received before eligibility requirements are met (excluding time requirements) are reported as liabilities, while resources received before time requirements are met, but after all other eligibility requirements have been met, are reported as deferred inflows of resources.

**CITY OF INDIANAPOLIS**  
**(A Component Unit of the Consolidated City of Indianapolis – Marion County)**  
Notes to Financial Statements  
December 31, 2022  
(Dollars in Thousands)

---

Charges for services in the governmental funds, which are exchange transactions, are recognized as revenues when received in cash because they are generally not measurable until actually received.

All proprietary funds, fiduciary funds (with an exception for custodial funds that are compelled to disburse resources), and the discretely presented component unit financial statements are accounted for using the same measurement focus and basis of accounting as the government-wide financial statements. Their revenues are recognized when they are earned, and their expenses are recognized when they are incurred, except as to the accounting for certain pension and other postemployment benefit costs. The City records pension payments reimbursed by the State of Indiana as both revenue and expenditures/expense. Unfunded pension and other postemployment benefit obligations are recorded in the government-wide statements in the long-term liabilities due in more than one year.

The City reports the following major governmental funds:

The *General Fund* is the City's primary operating fund. It accounts for all financial resources of the general government, except those required to be accounted for in another fund.

The *Revenue Bond Debt Service Fund* accounts for the resources accumulated and payments made for principal and interest on debt of the Tax Increment Districts and on debt issued for certain other public works projects.

The *Coronavirus Federal Stimulus Fund* accounts for the resources received and payments made related to the Coronavirus pandemic and federal funding provided from the American Rescue Plan Act (ARPA)

The *Redevelopment District Tax Increment Capital Project Fund* accounts for all financial resources related to projects constructed from proceeds of the Redevelopment District Tax Increment bond issues.

Additionally, the City reports the following fund types:

*Internal Service Funds* account for the accumulation of resources to provide for the financing of workers' compensation and auto liability, and health self-insurance for all City departments, as well as provide for the centralization of certain payments of awards, refunds, and indemnities.

*Fiduciary Funds* are classified into subgroupings – Custodial Funds and Pension and Other Postemployment Benefit Trust Funds. Funds in this classification are used to account for assets held by the City in a fiduciary capacity. Custodial Funds are custodial in nature and account for monies held on behalf of contractors, the E-911 dispatch program, and for confiscated items related to public safety activities. Pension and Other Postemployment Benefit Trust Funds are those funds held in trust for disbursement to covered employees with certain balances going to union trust funds. The City records deductions for pension and other postemployment benefit obligations as payments become due.

Amounts reported as *program revenues* include: (1) charges to customers or applicants for goods, services, or privileges provided, (2) operating grants and contributions, and (3) capital grants and contributions. Internally dedicated resources are reported as *general revenues* rather than as program revenues. Likewise, general revenues include all local taxes. State-shared revenues, such as cigarette taxes, are reported as grants and contributions not restricted to specific functions, unless they are restricted to specific functions, such as gasoline taxes, in which case they are reported as operating grants and contributions.

Indirect costs are included as part of the program expenditures reported for individual functions and activities.

#### **D. Cash and Investments**

The City's cash resources are combined to form a cash and investment pool managed by the City Controller. Excluded from this pool are the investments in TrustIndiana and certain legally restricted funds. Income from the pooled investments is allocated to the funds based on the participating fund's average daily equity balance. An individual fund's negative position in the pool is reflected as an interfund liability.

Investments are stated at fair value and are exposed to various risks, such as interest rate, market, and credit risks. Due to the level of risk associated with certain investment securities, it is at least reasonably possible that changes in the values of investment securities will occur in the near term and that such changes could materially affect the amounts reported in the accompanying statement of financial position.

**CITY OF INDIANAPOLIS**  
**(A Component Unit of the Consolidated City of Indianapolis – Marion County)**  
Notes to Financial Statements  
December 31, 2022  
(Dollars in Thousands)

---

**E. Receivables**

All receivables are shown net of an allowance, if any, for uncollectible balances.

Noncurrent portions of long-term receivables in the governmental funds are reported in their respective balance sheets, notwithstanding their measurement focus. The noncurrent portions of receivables that will ultimately result in the recognition of revenue are reported as deferred inflows of resources. Noncurrent portions of other long-term receivables (e.g., loans receivable and nonfinancial assets held for sale) are offset by assigned fund balance in the general fund and restricted fund balance in funds other than the general fund.

**F. Inventory**

Inventories of the governmental funds are recorded as expenditures when purchased and are therefore not recorded in the statement of net position or the governmental funds balance sheet, as the associated amounts are not considered material.

**G. Capital and Lease Assets**

**Capital Assets**

Capital assets, which include land, construction in progress, improvements, buildings, equipment, and infrastructure (e.g., streets, bridges, storm drains, and similar items), are reported in the government-wide financial statements. Capital assets are defined by the City as assets with cost or donated value beyond prescribed levels and estimated useful life in excess of two years. Such assets are recorded at historical cost or estimated historical cost, if purchased or constructed. Donated capital assets are recorded at acquisition value as of the date of acquisition. The costs of normal maintenance and repairs that do not add to the value of the asset or materially extend asset lives are not capitalized.

The prescribed capitalization levels for the City are as follows:

- All land acquired by the City is capitalized. Land improvements of \$25 or greater are capitalized.
- All new construction of City buildings is capitalized. Rehabilitation of \$75 or greater is capitalized.
- Equipment and vehicles of \$5 or greater are capitalized.
- Infrastructure projects of \$25 or greater are capitalized. Infrastructure assets acquired before January 1, 2002 have been capitalized if estimated historical cost or donated value was near or above the criteria for major infrastructure as defined by GASB Statement No. 34, *Basic Financial Statements – and Management’s Discussion and Analysis – for State and Local Governments* (“GASB Statement No. 34”).
- Assets, such as computer software and easements, are required to be reported as capital assets under GASB Statement No. 51, *Accounting and Financial Reporting for Intangible Assets*. All permanent easements have historically been capitalized. Other intangible assets are capitalized if the historical cost or donated value is \$100 or greater. The City has chosen not to report, retroactively to 1980, intangible assets having indefinite useful lives and those considered to be internally generated, except for certain computer software and right-of-way easements to which recognition criteria could be effectively applied.

Depreciation is calculated using the straight-line method and no salvage value. Depreciation lives are as follows:

Land improvements	30 years individual depreciation
Buildings	50 years individual depreciation
Building improvements	20 years individual depreciation
Equipment and vehicles	3 to 20 years individual depreciation
Streets, curbs, sidewalks, and traffic signals	30 years group depreciation
Bridges and storm lift stations	60 years individual depreciation
Storm mains, manholes, inlets, and culverts	60 years group depreciation

**CITY OF INDIANAPOLIS**  
**(A Component Unit of the Consolidated City of Indianapolis – Marion County)**  
Notes to Financial Statements  
December 31, 2022  
(Dollars in Thousands)

---

**Lease Assets**

Lease assets are initially recorded at the initial measurement of the lease liability, plus lease payments made at or before the commencement of the lease term, less any lease incentives received from the lessor at or before the commencement of the lease, plus initial direct costs that are ancillary to place the asset into service. Lease assets are amortized on a straight-line basis over the shorter of the lease term or the useful life of the underlying asset.

**H. Unearned Revenue**

Unearned revenue is reported in the government-wide financial statements and in the balance sheet – governmental funds. The availability period does not apply; however, amounts may not be considered earned due to eligibility requirements.

**I. Compensated Absences**

City civilian employees earn benefit leave days (in lieu of all vacation, sick, and other accrued leave time), which accumulate to a maximum of 37 days per year, depending on length of service. A total of 160 hours earned benefit leave can be carried forward to subsequent years. Accumulated unused sick leave earned before September 1, 1994 is payable only upon the death or retirement of an employee, and only half the accumulated sick leave is then payable. Uniform Police and Fire employees earn vacation and sick leave and other accumulated leave time off. For certain employees, sick leave is payable upon the death or retirement of the employee at half of the accumulated value.

In accordance with the vesting method provided under GASB Statement No. 16, *Accounting for Compensated Absences*, accumulated benefit and sick leave days are accrued based on assumptions concerning the probability that certain employees will become eligible to receive these benefits in the future. The entire cost of benefit and sick leave is recorded in the government-wide financial statements. Certain amounts have been recorded in the governmental fund financial statements, since such amounts came due (matured, for example, as a result of employee resignations and retirements) during the year ended December 31, 2022.

**J. Estimates and Uncertainties**

The presentation of financial statements in conformity with U.S. generally accepted accounting principles requires management to make estimates and assumptions that affect the reported amounts of assets, deferred outflows of resources, liabilities, and deferred inflows of resources, the disclosure of contingent assets and liabilities at the date of the financial statements, and the reported changes in amounts of revenues, expenses, and expenditures during the reporting period. Actual results could differ from those estimates.

**K. Interfund Transactions**

All outstanding balances between funds are reported as “due to/from other funds.”

**Transfers**

Legally authorized transfers are reported when incurred as transfers in by the recipient fund and as transfers out by the disbursing fund.

**Interfund Services Provided/Used**

Charges or collections for services rendered by one fund for another are recognized as revenues (interfund services provided) of the recipient fund and expenditures (interfund services used) of the disbursing fund. These transactions are recorded as interfund services because they would be treated as revenues and expenditures if they involved organizations external to the City. Certain internal payments are treated as a reduction of expense, such as reimbursements.

As a general rule, the effect of interfund activity has been eliminated from the government-wide financial statements.

**L. Bond Premiums, Discounts, and Issuance Costs**

In the government-wide financial statements and the proprietary fund types in the fund financial statements, bond or note premiums and discounts are recorded as an addition or reduction to the debt obligation. Premiums and discounts are amortized as a component of interest expense over the term of the related bonds using the effective-interest method. Bond issuance costs, excluding bond insurance, are expensed as incurred.

**CITY OF INDIANAPOLIS**  
**(A Component Unit of the Consolidated City of Indianapolis – Marion County)**  
Notes to Financial Statements  
December 31, 2022  
(Dollars in Thousands)

---

In the fund financial statements, governmental funds recognize bond premiums and discounts during the current period. The face amount of debt issued is reported as other financing sources. Premiums received on debt issuances are reported as other financing sources, while discounts on debt issuances are reported as other financing uses. Bond issuance costs, whether or not withheld from the actual debt proceeds received, are reported as debt service expenditures.

**M. Other Postemployment Benefit Plan**

The City has a single-employer defined benefit other postemployment benefit (OPEB) plan. For purposes of measuring the net OPEB liability, deferred outflows of resources and deferred inflows of resources related to OPEB, and OPEB expense, information about the fiduciary net position of the OPEB Plan and additions to/deductions from the OPEB Plan's fiduciary net position have been determined on the same basis as they are reported by the OPEB Plan. For this purpose, benefit payments are recognized when due and payable in accordance with the benefit terms. Investments are reported at fair value.

**N. Pensions**

For purposes of measuring the net pension liability or asset, deferred outflows of resources and deferred inflows of resources related to pensions, and pension expense, information about the fiduciary net position of the 1953 Police Pension Fund, the 1937 Firefighters' Pension Fund, the 1977 Police Officers' and Firefighters' Pension and Disability Fund, and the Indiana Public Employees' Retirement Fund ("the plans"), and additions to/deductions from the plans' fiduciary net position have been determined on the same basis as they are reported by the plans. For this purpose, plan contributions are recognized as of employer payroll paid dates and benefit payments and refunds are recognized when due and payable in accordance with the benefit terms. Investments are valued in accordance with the provisions of GASB Statement No. 72, *Fair Value Measurement and Application*, and are predominantly at fair value.

**O. Net Position/Fund Balances**

In the government-wide and proprietary fund financial statements, the components of net position are categorized as follows:

- 1) *Net investment in capital assets* – This category is comprised of capital assets including lease assets, net of accumulated depreciation and amortization, less the outstanding balances of any bonds, notes, or other borrowings that are attributable to the acquisition or construction of those assets.
- 2) *Restricted* – This category consists of resources that have external restrictions imposed by outside parties (e.g., creditors, grantors, contributors) or by law through constitutional provisions or enabling legislation.
- 3) *Unrestricted* – This category represents resources of the City that are not subject to externally imposed restrictions and that may be used to meet the ongoing obligations to the public and creditors.

When both restricted and unrestricted resources are available for use, it is the City's policy to use restricted resources first, then unrestricted resources as they are needed.

GASB Statement No. 54, *Fund Balance Reporting and Governmental Fund Type Definitions* ("GASB Statement No. 54") requires fund balances for governmental funds to be classified based on the extent to which the government is bound to honor constraints on the specific purposes for which amounts in those funds can be spent. Further, GASB Statement No. 54 establishes criteria for classifying fund balances and clarifies the definitions for governmental fund types.

Within the fund financial statements, the fund balances are classified in the following manner:

- 1) *Nonspendable* – This consists of resources that are either: (a) not in spendable form or (b) legally or contractually required to be maintained intact.
- 2) *Restricted* – This consists of resources that can be spent only for the specific purpose stipulated by constitution, external parties (e.g., grantors, creditors, or other governments), or enabling legislation.
- 3) *Committed* – This consists of resources that can only be used for specific purposes pursuant to formal action of the government's highest level of decision-making authority. The City's highest level of decision-making authority rests with the Council. Resources are reported as committed by the Council through passage of an ordinance. The Council can modify or rescind a commitment of resources through passage of a new ordinance.
- 4) *Assigned* – This consists of resources constrained by the government's intention to use them for specific purposes but are neither restricted nor committed. By statute, the City Controller has the ability to assign fund balance. The Council may also assign fund balance as it does when appropriating fund balance to cover a gap between estimated revenue

**CITY OF INDIANAPOLIS**  
**(A Component Unit of the Consolidated City of Indianapolis – Marion County)**  
Notes to Financial Statements  
December 31, 2022  
(Dollars in Thousands)

---

and appropriations in the subsequent year's appropriated budget. Unlike commitments, assignments are generally temporary and require no additional action to effect removal of the assignment. Within the assigned fund balance for the General Fund are encumbrances of \$53,082, which are assigned to cover future purchases.

- 5) *Unassigned* – This consists of residual fund balances that do not meet the criteria of nonspendable, restricted, committed, or assigned. The general fund is the only fund that reports a positive unassigned fund balance.

Effective August 2011, the Council established the Fiscal Stability Fund under Fiscal Ordinance No. 11, which is reported in the Consolidated County Subfund of the City's General Fund. At December 31, 2022, the unassigned fund balance of the Fiscal Stability Fund is \$81,463. Such amount has been set aside by the City-County Council to be maintained as a general reserve until such time the Council takes action to appropriate all or a portion of the balance. The ordinance that created the Fiscal Stability Fund does not dictate the circumstance under which such monies may be spent or provide requirements for any further additions to the fund.

The City's policy is to apply expenditures to restricted resources first, then committed, then assigned, and finally to unassigned, as applicable.

**P. Deferred Outflows of Resources and Deferred Inflows of Resources**

A deferred inflow of resources is an acquisition of net assets by the City that is applicable to a future reporting period and a deferred outflow of resources is a consumption of net assets by the City that is applicable to a future reporting period. Both deferred inflows and outflows are reported in the Statement of Net Position but are not recognized in the financial statements as revenues, expenses, and reduction of liabilities or increase in assets until the period(s) to which they relate.

The City reports both deferred outflows of resources and deferred inflows of resources in the statement of net position for the effects of certain changes in its net OPEB liability that is required to be included in OPEB expense over the current and future periods.

The City reports both deferred outflows of resources and deferred inflows of resources in the statement of net position for the effects of certain changes in its net pension liabilities that are required to be included in pension expense over the current and future periods.

The City defers recognition of losses incurred on bond refundings and reports such losses as deferred outflows of resources in the statement of net position. Deferred losses on refundings are amortized using the straight-line method over the lesser of the remaining life of the original bonds or the life of the new bonds.

In accordance with GASB Statement No. 60, *Accounting and Financial Reporting for Service Concession Arrangements* ("GASB Statement No. 60"), the City has recorded upfront payments received under a parking meter concession agreement as a deferred inflow of resources in the government-wide statement of net position. This deferred inflow of resources is being amortized using the straight-line method over the term of the agreement.

Deferred inflows of resources are also reported in the fund financial statements for receivables that are unavailable to liquidate liabilities of the current period or for which eligibility requirements have not been met. In addition, for certain lease liabilities that have been issued but the City has yet to receive funds or equipment, a lease receivable and deferred inflow of resources are recorded. Finally, deferred inflows are also reported where the City is the lessor and has reported a lease receivable and a deferred inflow of resources at the commencement of a lease. In the fund statements, the deferred inflow of resources includes \$546 related to leases and \$49,631 related to unavailable revenues.

**Q. Adoption of GASB Statement No. 87, Leases**

During 2022, the City implemented GASB Statement No. 87, *Leases* (GASB No. 87). This statement requires governments to recognize certain lease assets and liabilities for leases that previously were classified as operating leases and recognized as inflows of resources or outflows of resources based on the payment provisions of the contract. The adoption of GASB No. 87 resulted in an increase in beginning net position of \$17,823. As of January 1, 2022, the standard did result in the increase of lease assets and liabilities of \$46,617. Leases have been recognized and measured using the facts and circumstances that existed at the beginning of the year. Refer to Notes 9 and 11.G for the additional disclosures on these balances.

**R. Future Adoption of Accounting Standards**

GASB has issued; GASB No. 94, *Public-Private and Public-Public Partnerships and Availability Payment Arrangements*; GASB No. 96, *Subscription-Based Information Technology Arrangements*; GASB Statement No. 99, *Omnibus 2022*; GASB Statement No. 100, *Accounting Changes and Error Corrections*, an amendment of GASB Statement No. 62; and Statement No. 101, *Compensated Absences*. The City intends to adopt these GASB Statements, as applicable, on their respective effective dates.

**CITY OF INDIANAPOLIS**  
**(A Component Unit of the Consolidated City of Indianapolis – Marion County)**  
Notes to Financial Statements  
December 31, 2022  
(Dollars in Thousands)

---

**2. Cash Deposits and Investments**

As of December 31, 2022, the City had the following cash deposits and investments:

Cash and investments	\$	1,090,172
Cash and investments with fiscal agents		374,462
Cash and investments - fiduciary funds		7,923
Total cash and investments	\$	<u>1,472,557</u>

**Deposits**

Custodial credit risk is the risk that in the event of a bank failure, the City's deposits may not be returned to it. The City's deposit policy for custodial credit risk requires compliance with the provisions of Indiana statutes.

The carrying amount of the City's total cash deposits at December 31, 2022 was \$122,069. The City's cash deposits are insured up to \$250 at financial institutions insured by the Federal Deposit Insurance Corporation ("FDIC"). Any cash deposits in excess of the \$250 FDIC limits are partially or fully collateralized by the depository institution and insured by the Indiana Public Deposits Insurance Fund (Fund) via the pledged collateral from the institutions securing deposits of public funds. The Fund is a multiple financial institution collateral pool as provided under Indiana Code ("IC"), Section 5-13-12-1.

**Investments**

Indiana statutes authorize the City to invest in United States obligations and issues of federal agencies, secured repurchase agreements fully collateralized by U.S. Treasury or U.S. agency obligations, municipal securities of Indiana issuers that have not defaulted during the previous twenty years, certificates of deposit, and open-end money market mutual funds. Indiana statutes do not apply to the City's component units, which may invest in securities other than the aforementioned types of investments. The City policy provides that the City may invest in negotiable certificates of deposit having maturities of less than two years and in multiples of one million dollars providing that market yields on certificates of deposit exceed treasury bills of comparable maturity duration. The City has no investments in negotiable certificates of deposit at December 31, 2022.

It is the policy of the City to invest public funds in a manner that will provide the highest investment return with the maximum security while meeting the daily cash flow demands of the City and conforming to all state/local statutes governing the investment of public funds. The primary objectives, in priority order, of the City's investment activities shall be:

- **Safety:** Safety of principal is the foremost objective of the investment program. Investments of the City shall be undertaken in a manner that seeks to ensure the preservation of capital in the overall portfolio. To attain this objective, diversification is required in order to ensure that potential losses on individual securities do not exceed the income generated from the remainder of the portfolio.
- **Liquidity:** The City's investment portfolio will remain sufficiently liquid to enable the City to meet all operating requirements that might be reasonably anticipated.
- **Return on Investments:** The City's investment portfolio shall be designed with the objective of attaining a rate of return throughout budgetary and economic cycles, commensurate with the City's investment risk constraints and the cash flow characteristics of the portfolio.

**Interest Rate Risk**

Interest rate risk is the risk that the fair value of investments will be adversely affected by a change in interest rates. The City's investment policy provides that the City seeks to minimize the risk that the fair value of securities in its portfolio will decrease due to changes in general interest rates by structuring the investment portfolio so that securities mature to meet cash requirements for ongoing operations, thereby avoiding the need to sell securities on the open market prior to maturity. The City may invest in securities for more than two years and not more than five years in accordance with IC 5-13-9-5.7. Under this policy, investments having maturities of more than two years are limited to 25% of the total portfolio. In accordance with Indiana statutes, this policy will expire four years from its original effective date, or December 1, 2026.

**CITY OF INDIANAPOLIS**  
**(A Component Unit of the Consolidated City of Indianapolis – Marion County)**  
Notes to Financial Statements  
December 31, 2022  
(Dollars in Thousands)

Below is a segmented time distribution for the City’s debt investments at December 31, 2022:

<u>Investment Type</u>	<u>Fair Value</u>	<u>Investment Maturities (in Years) Less than 1</u>
U.S. Government-Sponsored Enterprise Securities:		
Federal Home Loan Bank	\$ 25,001	\$ 25,001
Total U.S. Government-Sponsored Enterprise Securities	<u>25,001</u>	<u>25,001</u>
United States Treasury Notes	262,004	262,004
Money Market Mutual Funds	295,014	295,014
State External Investment Pool – TrustIndiana	768,469	768,469
	<u>\$ 1,350,488</u>	<u>\$ 1,350,488</u>

**Credit Risk**

Credit risk is the risk that an issuer or other counterparty to an investment will not fulfill its obligations. Credit risk is measured using credit quality ratings of investments in debt securities as described by nationally recognized rating agencies. The City uses the highest integrity when choosing an instrument of investment. The City keeps its credit risk as it pertains to investments at a low rate by requiring all investments of the City be rated in the three highest ratings categories by Moody's Investor Service (“Moody’s”), Standard & Poor's Corporation (“S&P”), or Fitch's Ratings Service (“Fitch”).

At December 31, 2022, the City’s investments were rated by Moody's and S&P as follows:

<u>Investment Type</u>	<u>Fair Value</u>	<u>Ratings Moody's / S&amp;P</u>
U.S. Government-Sponsored Enterprise Securities:		
Federal Home Loan Bank	\$ 25,001	Aaa / AAA
Total U.S. Government-Sponsored Enterprise Securities	<u>25,001</u>	
United States Treasury Notes	262,004	Aaa / AAA
Money Market Mutual Funds	295,014	Aaa / AAA
State External Investment Pool – TrustIndiana	768,469	Not Rated
	<u>\$ 1,350,488</u>	

**Custodial Credit Risk**

Custodial credit risk is the risk that, in the event of the failure of the counterparty, the City will not be able to recover the value of the investments or collateral securities that are in the possession of the counterparty. The City’s investment policy requires that repurchase agreements be covered by adequate pledge collateral. In order to anticipate market changes and provide a level of security for all funds, the fair value (including accrued interest) of the collateral should be at least 102%.

At December 31, 2022, all City investments and all collateral securities pledged against City investments are held by the counterparty’s trust department or agent in the City’s name except for \$50,250, which is not held in the City’s name. The City’s investments in money market mutual funds and the state external investment pool were not subject to custodial credit risk at December 31, 2022, as their existence is not evidenced by securities that exist in physical book entry form.



**CITY OF INDIANAPOLIS**  
**(A Component Unit of the Consolidated City of Indianapolis – Marion County)**  
Notes to Financial Statements  
December 31, 2022  
(Dollars in Thousands)

**Concentration of Credit Risk**

The City places no limit on the amount that may be invested in any one issuer. At December 31, 2022, the City did not hold any investments that represent more than 5% of total investments.

**Foreign Currency Risk**

Foreign currency risk is the risk that changes in exchange rates will adversely affect the fair value of an investment or a deposit. The City’s investment policy prohibits investment in foreign securities.

**3. Disclosures About Fair Value of Assets**

Fair value is the price that would be received to sell an asset or paid to transfer a liability in an orderly transaction between market participants at the measurement date. Fair value measurements must maximize the use of observable inputs and minimize the use of unobservable inputs. There is a hierarchy of three levels of inputs that may be used to measure fair value:

- Level 1** Quoted prices in active markets for identical assets or liabilities
- Level 2** Observable inputs other than Level 1 prices, such as quoted prices for similar assets or liabilities; quoted prices in markets that are not active; or other inputs that are observable or can be corroborated by observable market data for substantially the full term of the assets or liabilities
- Level 3** Unobservable inputs supported by little or no market activity and are significant to the fair value of the assets or liabilities

**Recurring Measurements**

The following tables present the fair value measurements of assets recognized in the accompanying financial statements measured at fair value on a recurring basis and the level within the fair value hierarchy in which the fair value measurements fall at December 31, 2022:

	<u>Fair Value</u>	<u>Quoted Prices in Active Markets (Level 1)</u>	<u>Significant Other Observable Inputs (Level 2)</u>	<u>Significant Unobservable Inputs (Level 3)</u>
<b>Investment by fair value level</b>				
United States Treasury Notes	262,004	262,004	—	—
Federal Home Loan Bank	25,001	—	25,001	—
Money Market Mutual Funds	295,014	295,014	—	—
Total investments measured at fair value	\$ 582,019	\$ 557,018	\$ 25,001	\$ —
<b>Investments measured at the net asset value (NAV) (a)</b>				
State external investment pool - TrustIndiana	768,469			
Total	\$ 1,350,488			

- (a) Certain investments that are measured using the net asset value per share (or its equivalent) practical expedient have not been classified in the fair value hierarchy. The fair value amounts included above are intended to permit reconciliation of the fair value hierarchy to the amounts presented in the statement of financial position.

**Investments**

Where quoted market prices are available in an active market, securities are classified within Level 1 of the valuation hierarchy. If quoted market prices are not available, then fair values are estimated by using quoted prices of securities with similar characteristics or independent asset pricing services and pricing models, the inputs of which are market-based or independently sourced market parameters, including, but not limited to, yield curves, interest rates, volatilities, prepayments, defaults, cumulative loss projections, and cash flows. Such securities are classified in Level 2 of the valuation hierarchy. In certain cases where Level 1 or Level 2 inputs are not available, securities are classified within Level 3 of the hierarchy.

**CITY OF INDIANAPOLIS**  
**(A Component Unit of the Consolidated City of Indianapolis – Marion County)**  
Notes to Financial Statements  
December 31, 2022  
(Dollars in Thousands)

---

**Investments at NAV**

TrustIndiana, a local government investment pool, seeks to allow local units of government, as well as the State of Indiana, to invest in a common pool of investment assets that preserves the principal of the public's funds, remains highly liquid, and maximizes the return on the investment. There are no unfunded commitments or restrictions on redemptions.

**4. Property Taxes**

Property taxes levied for all governmental entities located within the County are collected by the Treasurer of Marion County, Indiana ("Treasurer"). These taxes are then distributed by the Auditor of Marion County, Indiana ("Auditor") to the City and the other governmental entities at June 30 and December 31 of each year. The City and the other governmental entities can request advances of their portion of the collected taxes from the Treasurer once the levy and tax rates are certified by the Indiana Department of Local Government Finance. The Indiana Department of Local Government Finance typically certifies the levy on or before January 15 of the year following the property tax assessment. Part of the budget certification process is to finalize the rates, which in turn gives units the ability to accurately project revenue loss due to the circuit breaker impact.

The City's 2022 property taxes were levied based on assessed valuations determined by the Auditor as of the 2021 assessed valuations, which were adjusted for estimated appeals, tax credits, and deductions. The lien date for the 2022 property taxes was January 1, 2021 (assessment date); however, the City does not recognize a receivable on the lien date, as the amount of property tax to be collected cannot be measured until the levy and tax rates are certified in the subsequent year. Taxable property is assessed at 100% of the true tax value. The first half of the year 2022 taxes were due and payable to the Treasurer in May 2022. The second half of the year 2022 taxes were due and payable to the Treasurer in November 2022. Property taxes outstanding at December 31, 2022, net of allowance for uncollectible accounts, are recorded as a receivable in the governmental fund and government-wide financial statements. However, for the governmental fund financial statements, all property tax receivable amounts are reported as deferred inflows of resources.

**5. Tax Abatements**

The City promotes a series of real and personal property tax abatement programs available under Indiana law, including:

Real Property Tax Abatement (IC 6-1.1-12.1)

Real property tax abatements are achieved through the phase-in of real property tax obligations from the improvements being made. The phase-in can span a period of one to ten years and is based on a declining percentage of the increase in assessed value of such improvements.

Tax abatement is granted based on qualifying new investment, retained and committed jobs, wages, and the economic impact of project. The City's Metropolitan Development Commission ("MDC") is responsible for approving the abatement and determining the time period for the abatement. In some cases, City-County Council approval is also required for the abatement. Required approval(s) must occur before construction permits are obtained.

Personal Property Tax Abatement (IC 6-1.1-12.1)

Similarly, personal property tax abatements for manufacturing, research and development, information technology, and logistics/distribution equipment are accomplished through the phase-in of personal property tax obligations over a one to ten year period, based on a declining percentage of the assessed value of the newly installed equipment.

Tax abatement is granted based on qualifying new investment, retained and committed jobs, wages, and the economic impact of project. MDC and possibly City-County Council approval is required and must occur prior to the equipment being operational, and the MDC determines the time period for the abatement.

Vacant Building Abatement (IC 6-1.1-12.1)

Up to a two-year real property tax abatement is available to a company, according to local qualifications, based on occupying a building that has been vacant for more than a year.

The building must be used for commercial or industrial purposes and be located in a designated Economic Revitalization Area, as designated by the MDC. Prior approval of the MDC must occur before occupying the facility, and the MDC determines the time period for the abatement.

All of these programs are designed to spur job creation and retention, grow the income and property tax base, support the redevelopment of areas experiencing a cessation of growth, attract and retain businesses in targeted industries, and assist distressed businesses, among other objectives. Minimum eligibility criteria for such abatements vary by program, as noted above, but generally require that an investment in real or personal property be projected to increase assessed value, create, or retain jobs, and/or promote economic revitalization.

**CITY OF INDIANAPOLIS**  
**(A Component Unit of the Consolidated City of Indianapolis – Marion County)**  
Notes to Financial Statements  
December 31, 2022  
(Dollars in Thousands)

---

In return for such abatements, the City generally commits to permit, zoning, and job training assistance. An abatement can be terminated if the MDC determines that the commitments made by the company receiving the abatement were not met and, per statute, such non-compliance was not due to factors beyond the company’s control. Included in each abatement agreement are provisions specifying certain damages, among which may include a clawback of some or all of the taxes previously abated. If a company ceases operations or announces the cessation of operations at the facility for which the abatement was granted, termination of the abatement agreement is warranted and 100% clawback is required. Other clawbacks are calculated based on the highest level of non-compliance among the measured categories for that project.

Impact of Abatements on Revenues

Indiana property tax laws complicate the calculation of the exact impact of property tax abatements on the tax revenues of a given unit of local government. Constraints on the growth of the annual tax levy and constitutional limitations on taxes (also known as property tax caps) are the chief complicating factors. The increase in the annual tax levy is limited to the growth in the 6-year moving average of nonfarm personal income growth, which is known as the Assessed Value Growth Quotient (“AVGQ”). Statutory property tax caps for homesteads, agricultural and other residential, and commercial are equal to 1%, 2%, and 3%, respectively, of associated assessed valuations.

The tax rate, which is established for each taxing unit by the Department of Local Government Finance, is based on the tax levy requested by the taxing unit (as limited by the AVGQ) divided by the net assessed value of the property in a physical taxing district. The theory behind the AVGQ is that the costs of government should not be increasing at a greater rate than taxpayer incomes.

Tax abatements are granted on the assessed value of the property abated. The taxpayer’s taxes are then calculated based on this reduced assessment, thus resulting in a lower tax liability. But because a given district’s tax rate is calculated based on the total net assessed value in the district (net of abatements and other adjustments), the certified levy of each unit in the district is the same as if the abatements had not been granted.

Additionally, to the extent that parcels have reached the constitutional limit of tax liability as a percentage of gross assessed value, the property tax rate caps (“circuit breaker credits”) reduce the property tax collections of the affected taxing units. The degree to which property tax abatements exacerbate circuit breaker losses differs by parcel and is dependent on the proportion of abated assessed value to total gross assessed value, as well as prevailing property tax rates.

The estimated gross amount, on an accrual basis, by which the total property tax revenues for the abatement taxpayer recipient (payable 2022 taxes) were reduced as a result of the aforementioned abatement programs follows:

Real Property Tax Abatement	\$	1,271
Personal Property Tax Abatement		2,023
Total	\$	3,294

While the City has calculated the potential impact of existing tax abatements on total property tax revenues for 2022, as shown above, the actual extent of lost revenues may be something less than this amount and cannot be easily determined due to the application of circuit breaker credits.

**CITY OF INDIANAPOLIS**  
**(A Component Unit of the Consolidated City of Indianapolis – Marion County)**  
Notes to Financial Statements  
December 31, 2022  
(Dollars in Thousands)

**6. Receivables Disaggregation**

Accounts receivable as of December 31, 2022, for the City, including the applicable allowances for uncollectible accounts, are as follows:

	<u>Accounts</u>	<u>Due from Other Governments</u>	<u>Total Accounts Receivable</u>
<b>Governmental Activities:</b>			
General Fund	\$ 12,889	\$ 22,022	\$ 34,911
Coronavirus Federal Stimulus Fund	160	—	160
Redevelopment District Tax Increment Capital Project Fund	240	—	240
Other Nonmajor Governmental Funds	1,108	631	1,739
Internal Service Fund	2,449	—	2,449
Total receivables	<u>16,846</u>	<u>22,653</u>	<u>39,499</u>
Allowance for uncollectible accounts	<u>(1,520)</u>	<u>—</u>	<u>(1,520)</u>
Total governmental activities	<u>\$ 15,326</u>	<u>\$ 22,653</u>	<u>\$ 37,979</u>

Accounts receivable includes amounts due from other governments, which represent local income and other taxes (excluding property taxes).

**7. Due from Federal and State Governments**

Amounts due under federal, state, and local grants at December 31, 2022 for specific programs and capital projects include:

	<b>Governmental Activities</b>			<b>Total</b>
	<u>General</u>	<u>Coronavirus Federal Stimulus</u>	<u>Other Nonmajor Governmental</u>	
Reimbursements under federal grants:				
Department of Housing and Urban Development (HUD)	\$ —	\$ —	\$ 13,549	\$ 13,549
Department of Justice (DOJ)	—	—	3,018	3,018
Environmental Protection Agency (EPA)	4	—	117	121
Department of Transportation (DOT)	—	—	356	356
U.S. Department of Interior (DOI)	—	—	214	214
U.S. Department of Treasury	—	1,678	52	1,730
U.S. Department of Commerce (DOC)	—	—	181	181
Department of Education (DOE)	—	—	5	5
Department of Homeland Security (DHS)	—	—	2,650	2,650
U.S. Department of Agriculture	—	—	147	147
Corporation for National and Community Service	—	—	13	13
Reimbursements under State of Indiana/local grants	<u>1</u>	<u>—</u>	<u>333</u>	<u>334</u>
	<u>\$ 5</u>	<u>\$ 1,678</u>	<u>\$ 20,635</u>	<u>\$ 22,318</u>

At December 31, 2022, the City had available lines of credit or grant authorizations from HUD totaling \$81,354.

**CITY OF INDIANAPOLIS**  
**(A Component Unit of the Consolidated City of Indianapolis – Marion County)**  
Notes to Financial Statements  
December 31, 2022  
(Dollars in Thousands)

---

**8. Long-Term Receivables**

The City has receivables for U.S. Department of Housing and Urban Development (“HUD”) loans outstanding at December 31, 2022 of \$24,340, including accrued interest of \$11,822. The City has provided a reserve of \$24,340 for these receivables given the uncertainty of collection. Many of these loans bear interest at rates ranging from 0% to 10% and mature over the next 25 years. Generally, principal and interest payments are based upon defined net cash flows and are deferred until sufficient cash flow is available. All deferred principal and interest amounts are due at maturity. Loan repayments to the City are restricted for community and economic development purposes that would otherwise be eligible for reimbursement by HUD under Title I of the Housing and Community Development Act of 1974.

The City has loaned Herron High School, Inc. (“Herron”) \$1,500 under an Interlocal Agreement dated December 19, 2017 and the associated Loan Agreement. The loan proceeds were used to finance the construction, acquisition, design, renovation, and equipping of the Heslar Naval Armory. Over the term of this agreement, which expires in 2055, the City will forgive up to \$1,500 of the loan if certain percentages of the student population are eligible for the Free and Reduced Lunch program. At December 31, 2022, the City has recorded a \$1,500 reserve against the long-term receivable to fully reserve the loan.

On September 1, 2019, the City issued its Economic Development Revenue Bonds, Series 2019 PR Mallory Building Project in the amount of \$12,275. The proceeds will be used to acquire, rehabilitate, renovate, and equip two buildings on the PR Mallory Campus offering approximately 187,000 square feet of space to accommodate innovative educational facilities, commercial and office space, indoor hydroponic agricultural operations, and onsite parking. The bonds are secured by TIF revenues generated within the PR Mallory North Allocation Area and the PR Mallory South Allocation Area. Bonds are payable from payments made by the leverage lender and further secured by certain collateral and a reserve fund to be initially funded from funds on hand of the leverage lender. If draws are made on the reserve fund, it will be replenished from available PR Mallory TIF Revenues generated and collected in the PR Mallory North Allocation Area and PR Mallory South Allocation Area. At December 31, 2022, the long-term receivable is \$12,275.

In 2013, the City was awarded a \$39,000 Section 108 Loan to create the Community & Economic Development Loan Program (“CEDLP”). The City will loan these funds to entities with eligible projects for economic development and housing development activities to benefit low to moderate income individuals. Section 108 provides communities with a source of financing for economic development, housing rehabilitation, public facilities, and large-scale physical development projects or to aid in the prevention of slums. On March 31, 2016, the City loaned the Meadows Community Foundation \$1,600; the loan will mature on March 31, 2036. Principal payments are due annually and interest payments are due quarterly. The City will use the payments received from Meadows Community Foundation to repay the loan to HUD. At December 31, 2022, the long-term receivable and the outstanding balance is \$255. On October 20, 2017, the City loaned Ford TWG, LLC (Ford) \$4,650, the loan will mature on August 1, 2037. Principal payments are due annually and interest payments are due quarterly. The City will use the payments received from Ford to repay the loan to HUD. At December 31, 2022, the long-term receivable and the outstanding balance is \$4,650.

In 2015, the CAC loaned \$596 to a project investor, NOS Preferred Equity Investor, LLC. The advance to the project investor was made pursuant to a promissory note for \$18,250 dated December 31, 2016, between the CAC and the project investor. Additional proceeds under the note were drawn by the project investor in 2017 and 2018 to fund the City Way II project. Repayment terms included semi-annual interest only payments through January 2018 followed by principal and interest payments through maturity with a balloon payment due in December 2035. Repayment of the note is guaranteed by Buckingham Property Holdings, LLC, in the event that the property tax revenues generated by the project do not meet specified levels. NOS Preferred Equity Investor, LLC and Buckingham Property Holdings, LLC are related by common ownership. At December 31, 2022, the long-term receivable is \$13,738.

On May 15, 2018, the City issued its Economic Development Revenue Bonds, Series 2018 (Phoenix Theatre Project) in the amount of \$4,500. The proceeds will be used to provide funds to finance the construction of the Phoenix Theatre Education and Innovation Center. Bonds are payable from payments made by the developer further secured by certain collateral and a reserve fund funded by the developer upon closing. If draws are made on the reserve fund, it will be replenished from available consolidated TIF revenues generated and collected in the Consolidated TIF allocation area, if required, and the repayment obligations of the Phoenix bonds is evidenced by the Developers Note. At December 31, 2022, the long-term receivable is \$4,245.

In 2020, the City issued its Economic Development Tax Increment Revenue Bonds, Series 2020 (421 N Penn Project) in the amount of \$9,852. As part of the arrangement, the City entered into a financing agreement with CSP 421 N. Penn Street, LLC, in which the Developer agreed to pay a commission fee totaling \$150 to the City. The amount due is scheduled to be paid in three equal installments – the first to be paid before or upon issuance of the bonds, and the second and third to be paid before or on the fourth and fifth anniversary of the bond issuance, respectively. At December 31, 2022, the long-term receivable is \$100.

In 2020, the City loaned the Housing Agency \$1,500. The loan was intended to provide financial aid to the Housing Agency as they act on the guidelines established with IC 36-7-15.1 (the “Redevelopment Act”), which promotes the use of land in the manner that best serves the interests of the City and its inhabitants, to assess, clear, remediate, replan, and redevelop areas needing redevelopment, to remedy and control obsolescence and deteriorated conditions of improvements, environmental contamination, faulty land use, shifting of population, and technological and social

**CITY OF INDIANAPOLIS**  
**(A Component Unit of the Consolidated City of Indianapolis – Marion County)**  
Notes to Financial Statements  
December 31, 2022  
(Dollars in Thousands)

---

changes, for the benefit of the health, safety, and welfare of the City and its inhabitants, and to protect and increase property values in the City. At December 31, 2022, the long-term receivable is \$1,500.

In 2021, nationwide settlements were reached to resolve all opioids litigation brought by states and local political subdivisions against three pharmaceutical distributors and one manufacturer of opioids. In all, the distributors and manufacturer will pay up to \$26,000,000 over 18 years in a multi-state agreement; the State of Indiana’s portion of the settlement is \$507,000. The settlement was deemed available to be estimated during 2022 when allocations to the individual units were determined. In accordance with the terms of the settlement, 85% will be restricted for future opioid remediation, while 15% is unrestricted. The City and County have been allocated a total amount of \$36,743 that will be paid over an 18-year period. The City and County received the first distribution of the 18-year settlement in 2022 for \$4,200 and \$3,199, respectively. The remaining long-term receivable at December 31, 2022 of \$20,402 has been discounted and recorded by the City. Any future allocation provided to the County will be determined on an annual basis.

The minimum future payments to be received as of December 31, 2022 on long-term receivables are as follows:

		<b>Governmental Activities</b>
2023	\$	2,779
2024		2,184
2025		2,161
2026		2,367
2027		14,743
2028-2032		17,332
2033-2037		21,526
2038-2042		3,884
2043-2047		15,604
2048-2052		250
2053-2057		175
		83,005
Less: allowance		(25,840)
Total	\$	57,165

**CITY OF INDIANAPOLIS**  
**(A Component Unit of the Consolidated City of Indianapolis – Marion County)**  
Notes to Financial Statements  
December 31, 2022  
(Dollars in Thousands)

**9. Capital Assets and Lease Assets**

Following is a summary of changes in capital assets for the City’s governmental activities for the year ended December 31, 2022:

	<u>Balance, January 1, 2022 (1)</u>	<u>Additions</u>	<u>Reductions</u>	<u>Balance, December 31, 2022</u>
<b>Governmental Activities:</b>				
Capital assets not being depreciated:				
Land	\$ 87,693	\$ 6,505	\$ —	\$ 94,198
Construction in progress	390,598	267,498	131,264	526,832
Total capital assets not being depreciated	<u>478,291</u>	<u>274,003</u>	<u>131,264</u>	<u>621,030</u>
Capital assets being depreciated:				
Buildings	420,843	9,682	—	430,525
Improvements	261,082	2,830	305	263,607
Equipment	266,737	6,189	13,536	259,390
Infrastructure	3,354,683	121,837	24,358	3,452,162
Total capital assets being depreciated	<u>4,303,345</u>	<u>140,538</u>	<u>38,199</u>	<u>4,405,684</u>
Less accumulated depreciation:				
Buildings	233,871	10,520	—	244,391
Improvements	135,366	8,130	—	143,496
Equipment	189,591	13,488	11,153	191,926
Infrastructure	2,579,783	110,116	—	2,689,899
Total accumulated depreciation	<u>3,138,611</u>	<u>142,254</u>	<u>11,153</u>	<u>3,269,712</u>
Total capital assets being depreciated, net	<u>1,164,734</u>	<u>(1,716)</u>	<u>27,046</u>	<u>1,135,972</u>
Governmental activities capital assets, net	<u>\$ 1,643,025</u>	<u>\$ 272,287</u>	<u>\$ 158,310</u>	<u>\$ 1,757,002</u>

(1) Beginning balances were restated due to the implementation of GASB 87-*Leases*

**CITY OF INDIANAPOLIS**  
**(A Component Unit of the Consolidated City of Indianapolis – Marion County)**  
Notes to Financial Statements  
December 31, 2022  
(Dollars in Thousands)

Following is a summary of changes in lease assets activity for the City’s governmental activities for the year ended December 31, 2022:

	<b>Balance, January 1, 2022 (1)</b>	<b>Additions</b>	<b>Reductions</b>	<b>Balance, December 31, 2022</b>
<b>Governmental Activities:</b>				
Lease assets being amortized:				
Buildings	\$ 13,652	\$ 3,791	\$ —	\$ 17,443
Equipment	32,965	5,101	—	38,066
Total lease assets being amortized	<u>46,617</u>	<u>8,892</u>	<u>—</u>	<u>55,509</u>
Less accumulated amortization:				
Buildings	—	2,349	—	2,349
Equipment	—	3,603	—	3,603
Total accumulated amortization	<u>—</u>	<u>5,952</u>	<u>—</u>	<u>5,952</u>
Total lease assets being amortized, net	<u>46,617</u>	<u>2,940</u>	<u>—</u>	<u>49,557</u>
Governmental activities lease assets, net	<u>\$ 46,617</u>	<u>\$ 2,940</u>	<u>\$ —</u>	<u>\$ 49,557</u>

(1) Beginning balances were restated due to the implementation of GASB 87-*Leases*



**CITY OF INDIANAPOLIS**  
**(A Component Unit of the Consolidated City of Indianapolis – Marion County)**  
Notes to Financial Statements  
December 31, 2022  
(Dollars in Thousands)

Following is a summary of the changes in capital assets for the City’s discretely presented component unit, the Housing Agency, for the year ended December 31, 2022:

	<u>Balance, January 1, 2022</u>	<u>Additions</u>	<u>Reductions</u>	<u>Balance, December 31, 2022</u>
<b>Housing Agency</b>				
Capital assets not being depreciated:				
Land	\$ 21,075	\$ 181	\$ —	\$ 21,256
Construction in progress	<u>—</u>	<u>—</u>	<u>—</u>	<u>—</u>
Total capital assets not being depreciated	<u>21,075</u>	<u>181</u>	<u>—</u>	<u>21,256</u>
Capital assets being depreciated:				
Buildings and improvements	226,982	—	12,598	214,384
Equipment	14,845	—	859	13,986
Total capital assets being depreciated	<u>241,827</u>	<u>—</u>	<u>13,457</u>	<u>228,370</u>
Less accumulated depreciation:				
Buildings and improvements	87,488	6,107	3,710	89,885
Equipment	8,974	1,364	975	9,363
Total accumulated depreciation	<u>96,462</u>	<u>7,471</u>	<u>4,685</u>	<u>99,248</u>
Total capital assets being depreciated, net	<u>145,365</u>	<u>(7,471)</u>	<u>8,772</u>	<u>129,122</u>
Total Housing Agency	<u>\$ 166,440</u>	<u>\$ (7,290)</u>	<u>\$ 8,772</u>	<u>\$ 150,378</u>

Within the statement of activities, depreciation and amortization expense was charged to functions/programs of the City during 2022 as follows:

<b>Governmental Activities:</b>	<u>Depreciation</u>	<u>Amortization</u>
General government	\$ 5,554	\$ —
Public safety	9,524	3,964
Public works	116,554	1,943
Cultural and recreation	6,187	—
Urban redevelopment and housing	4,435	45
	<u>\$ 142,254</u>	<u>\$ 5,952</u>

Depreciation expense of \$7,471 was charged to the City’s discretely presented component unit, the Housing Agency, during 2022.

Construction in progress at December 31, 2022 consists of several ongoing projects. These types of projects include, but are not limited to, security upgrades, recreational facility improvements, and infrastructure improvements.

**CITY OF INDIANAPOLIS**  
**(A Component Unit of the Consolidated City of Indianapolis – Marion County)**  
Notes to Financial Statements  
December 31, 2022  
(Dollars in Thousands)

At December 31, 2022, the City’s commitments relating to construction in progress include the following:

	<u>Authorized</u>	<u>Accrued Expenditures Through December 31, 2022</u>	<u>Committed</u>
Executive and Legislative	\$ 38,194	\$ 35,556	\$ 2,638
Indianapolis Metropolitan Police Department	17,712	17,330	382
Department of Metropolitan Development	12,913	9,856	3,057
Department of Public Works	539,324	430,492	108,832
Indianapolis Fire Department	23,487	22,803	684
Department of Parks and Recreation	17,982	10,795	7,187
Total Governmental Activities	<u>\$ 649,612</u>	<u>\$ 526,832</u>	<u>\$ 122,780</u>

**10. Accounts Payable and Other Accrued Liabilities Disaggregation**

Accounts payable and other current liabilities as of December 31, 2022 for the City are as follows:

	<u>Vendors</u>	<u>Third-Party Contracts</u>	<u>Due to Other Governments</u>	<u>Claims and Settlements</u>	<u>Accrued Payroll and Taxes</u>	<u>Total Payables and Other Current Liabilities</u>
<b>Governmental Activities:</b>						
General Fund	\$ 45,602	\$ 4,739	\$ 610	\$ —	\$ 16,838	\$ 67,789
Coronavirus Federal Stimulus	11,710	676	48	—	—	12,434
Revenue Debt Service	—	—	—	—	—	—
Redevelopment District Tax Increment Capital Project	3,467	431	—	—	—	3,898
Other Nonmajor Governmental	18,511	5,944	1,822	—	109	26,386
Internal Service Fund	1,520	—	—	21,896	—	23,416
Adjustment to government-wide	—	—	—	3,707	—	3,707
Total governmental activities	<u>\$ 80,810</u>	<u>\$ 11,790</u>	<u>\$ 2,480</u>	<u>\$ 25,603</u>	<u>\$ 16,947</u>	<u>\$ 137,630</u>

**CITY OF INDIANAPOLIS**  
**(A Component Unit of the Consolidated City of Indianapolis – Marion County)**  
Notes to Financial Statements  
December 31, 2022  
(Dollars in Thousands)

**11. Long-Term Liabilities**

**A. Changes in Long-Term Liabilities**

The following is a summary of changes in long-term liabilities for the City's governmental activities and for its discretely presented component unit, the Housing Agency, for the year ended December 31, 2022:

	Balance, January 1, 2022 (1)	Additions	Reductions	Balance, December 31, 2022	Due within One Year
<b>Governmental Activities:</b>					
Bonds payable:					
General obligation bonds payable	\$ 309,480	\$ 23,500	\$ 17,020	\$ 315,960	\$ 9,060
General obligation bonds from direct borrowing and direct placements	12,805	—	1,005	11,800	1,025
Tax increment bonds payable	468,247	121,267	83,564	505,950	42,485
Tax increment bonds from direct borrowing and direct placements	102,176	83,351	15,271	170,256	14,106
Revenue bonds payable	251,385	50,000	14,400	286,985	760
Revenue bonds from direct borrowing and direct placements	12,330	—	445	11,885	—
Unamortized amounts:					
Premiums	77,286	31,973	11,585	97,674	—
Total bonds payable	1,233,709	310,091	143,290	1,400,510	67,436
Notes payables from direct borrowings and direct placements	130,723	34,767	73,585	91,905	21,636
Financed purchase obligations	310	32,755	1,136	31,929	2,725
Lease liabilities	46,617	8,892	9,378	46,131	10,196
Net pension liabilities	752,245	313,687	316,204	749,728	—
Other postemployment benefit liability	245,607	19,719	49,542	215,784	—
Early retirement obligation	1,622	—	1,622	—	—
Compensated absences	42,564	34,595	35,731	41,428	22,290
Total governmental activities	\$ 2,453,397	\$ 754,506	\$ 630,488	\$ 2,577,415	\$ 124,283
<b>Discretely Presented Component Unit - Housing Agency:</b>					
Notes payable	\$ 18,952	\$ —	\$ 6,253	\$ 12,699	\$ 952
Due to other governmental units	3,185	3,413	—	6,598	2,623
FSS escrow	422	—	7	415	111
Net pension liability	1,060	1,057	—	2,117	—
Total discretely presented component unit	\$ 23,619	\$ 4,470	\$ 6,260	\$ 21,829	\$ 3,686

(1) Beginning balances were restated due to the implementation of GASB 87 - Leases

Included in additions to bonds payable is \$8,741 representing accretion on capital appreciation bonds, which is not included in the statement of revenues, expenditures, and changes in fund balance. This amount plus \$368,872 of bonds, notes, and financed purchase obligations reported in the statement of revenues, expenditures, and changes in fund balance amounts to the \$377,613 of related additions reflected in the roll forward above.

**CITY OF INDIANAPOLIS**  
**(A Component Unit of the Consolidated City of Indianapolis – Marion County)**  
Notes to Financial Statements  
December 31, 2022  
(Dollars in Thousands)

**B. General Obligation Bonds**

The City's general obligation bonds provide funds for the acquisition and construction of major capital facilities. General obligation bonds are direct obligations and pledge the full faith and credit of the City. General obligation bonds outstanding as of December 31, 2022 are as follows:

	<u>Issue Date</u>	<u>Final Maturity Date</u>	<u>Interest (All Maturities)</u>	<u>Outstanding</u>
<b>Civil City Bonds:</b>				
Consolidated City, Series 2017A	02/01/2017	01/15/2038	3.125 – 5.000	15,720
Consolidated City, Series 2021A	12/14/2021	01/15/2041	3.000 – 5.000	15,570
Consolidated City, Series 2022A	12/15/2022	01/15/2043	5.250 – 5.500	11,500
Consolidated City, Taxable Series 2022B	12/15/2022	01/15/2035	4.798 – 5.337	12,000
<b>Direct borrowings and direct placements:</b>				
Fire Training Facility, Series 2019A*	11/26/2019	01/15/2033	2.010	<u>11,800</u>
Total Civil City Bonds				<u>66,590</u>
<b>Public Safety Communication System Bonds:</b>				
Public Safety Communication District Bonds, Series 2017A	02/01/2017	01/01/2028	5.000	7,835
Public Safety Communication District Bonds, Series 2017B	02/01/2017	01/01/2024	1.600 – 3.050	4,090
Public Safety Communication District Bonds, Series 2020A	01/22/2020	01/01/2029	1.881	<u>25,730</u>
Total Public Safety Communication System Bonds				<u>37,655</u>
<b>Metropolitan Thoroughfare District Bonds:</b>				
Metropolitan Thoroughfare District, Series 2017A	02/01/2017	01/11/2032	3.125 – 5.000	19,115
IndyRoads Metropolitan Thoroughfare District Bonds, Series 2020A	10/13/2020	01/01/2041	4.000 – 5.000	50,000
IndyRoads Metropolitan Thoroughfare District Refunding Bonds, Series 2020B	10/13/2020	01/01/2040	0.383 – 2.473	<u>130,470</u>
Total Metropolitan Thoroughfare District Bonds				<u>199,585</u>
<b>Park District Bonds:</b>				
Park District Bonds, Series 2017A	02/01/2017	01/01/2028	4.000 – 5.000	3,235
Park District Bonds, Series 2021A	12/14/2021	01/15/2041	3.000 – 5.000	<u>20,695</u>
Total Park District Bonds				<u>23,930</u>
Total general obligation bonds recorded in governmental activities				327,760
Less: matured bonds payable recorded in the debt service funds				<u>(7,255)</u>
				<u>\$ 320,505</u>

\*These bonds are issued directly to a small number of investors rather than as a public offering.

All principal and interest payments for the City's general obligation bonds are due on January 1 and July 1 or January 15 and July 15 of the respective year. Accordingly, the City appropriates all payments due in January in the year before payment is due and provides the amount in the Debt Service Funds. All serial bond principal and interest payments due in January 2023 have been recorded as matured bonds payable and matured interest payable at December 31, 2022 within the fund financial statements. All general obligation bonds have pledges of all proceeds of the Trust Estate.

**CITY OF INDIANAPOLIS**  
**(A Component Unit of the Consolidated City of Indianapolis – Marion County)**  
Notes to Financial Statements  
December 31, 2022  
(Dollars in Thousands)

On December 15, 2022, the City issued its Consolidated Civil City Bonds, Series 2022A in the amount of \$11,500. The proceeds will be used for the acquisition, design, planning, enabling work, site-work, construction, installation, equipping and/or financing of all or a portion of the following projects: a new fire station for Ladder 20 and related improvements, necessary repair and renovation of numerous Indianapolis Fire Department stations, and sidewalks, road and streetscapes, a pavilion or other public infrastructure, landscaping, and all related work necessary to complete the improvements at or near to Dr. Martin Luther King Jr. Park. The bonds mature on January 15, 2043 and have an interest rate of 5.25%-5.50%.

On December 15, 2022, the City issued its Consolidated Civil City Bonds, Taxable Series 2022B in the amount of \$12,000. The proceeds will be used for repair, replacement and enhancement of City Market infrastructure including work to the market house, west plaza, and Wabash Alley. The bonds mature on January 15, 2035 and have an interest rate of 4.798%-5.337%.

Annual debt service requirements to maturity for general obligation bonds are as follows:

Years Ending December 31	Civil City		Direct Borrowing and Direct Placement - Civil City		Metropolitan Thoroughfare	
	Principal	Interest	Principal	Interest	Principal	Interest
	2023	\$ 2,125	\$ 1,956	\$ 1,025	\$ 232	\$ 1,540
2024	1,955	2,367	1,045	211	4,090	5,397
2025	2,335	2,261	1,065	190	5,735	5,257
2026	2,450	2,144	1,085	169	7,900	5,060
2027	2,560	2,020	1,105	147	10,025	4,827
2028 - 2032	10,675	8,440	5,880	390	59,250	19,813
2033 - 2037	15,225	5,695	595	6	58,375	12,226
2038 - 2042	15,760	2,056	—	—	52,670	3,590
2043 - 2047	1,705	47	—	—	—	—
<b>Total</b>	<b>\$ 54,790</b>	<b>\$ 26,986</b>	<b>\$ 11,800</b>	<b>\$ 1,345</b>	<b>\$ 199,585</b>	<b>\$ 59,328</b>

	Park		Public Safety Communications System		Total	
	Principal	Interest	Principal	Interest	Principal	Interest
	2023	\$ 1,015	\$ 1,013	\$ 4,380	\$ 725	\$ 10,085
2024	985	963	7,775	825	15,850	9,763
2025	860	917	6,005	648	16,000	9,273
2026	900	873	6,185	464	18,520	8,710
2027	950	826	6,380	273	21,020	8,093
2028 - 2032	5,545	3,349	6,930	136	88,280	32,128
2033 - 2037	7,005	1,891	—	—	81,200	19,818
2038 - 2042	6,670	442	—	—	75,100	6,088
2043 - 2047	—	—	—	—	1,705	47
<b>Total</b>	<b>\$ 23,930</b>	<b>\$ 10,274</b>	<b>\$ 37,655</b>	<b>\$ 3,071</b>	<b>\$ 327,760</b>	<b>\$ 101,004</b>

**CITY OF INDIANAPOLIS**  
**(A Component Unit of the Consolidated City of Indianapolis – Marion County)**  
Notes to Financial Statements  
December 31, 2022  
(Dollars in Thousands)

**C. Tax Increment Revenue Bonds**

These bonds are issued to provide funds for the construction and maintenance of the City’s infrastructure, such as streets and sidewalks and certain economic development projects. These bonds will be repaid from amounts levied against the property owners that will benefit by this construction. Tax increment revenue bonds outstanding as of December 31, 2022 are as follows:

	<u>Issue Date</u>	<u>Final Maturity Date</u>	<u>Interest (All Maturities)</u>	<u>Outstanding</u>
Redevelopment District, Series 1999B:				
Capital appreciation	08/12/1999	02/01/2029	5.650% – 5.820%	\$ 179,970
Less: discount				<u>(25,045)</u>
				<u>154,925</u>
Redevelopment District Bonds, Series, 2007 (Glendale)	05/10/2007	02/01/2027	5.450 – 6.210	1,940
Redevelopment District Bonds, Series 2010 (Dow AgroSciences)	06/22/2010	02/01/2025	3.000 – 5.125	6,020
Redevelopment District Bonds, Series 2011A	03/10/2011	08/01/2024	0.500 – 5.000	6,680
Redevelopment District Bonds, Series 2011C	05/19/2011	02/01/2036	4.000 – 5.750	19,065
Redevelopment District Refunding Bonds, Series 2014 (Fall Creek Project)	06/26/2014	02/01/2029	0.450 – 4.500	5,465
Redevelopment District Refunding Bonds 2016A (Marriott)	10/19/2016	02/01/2038	3.000 – 5.000	46,630
Redevelopment District Refunding Bonds, Series 2018 (Taxable)(Market District Garage)	01/11/2018	01/15/2033	4.150	9,450
Economic Development Revenue Bonds, Series 2014A (Mass. Ave. Project)	09/03/2014	02/01/2031	5.000	27,320
Economic Development Revenue Bonds, Series 2014B Taxable (Mass. Ave. Project)	09/03/2014	02/01/2024	2.300 – 3.430	1,260
Economic Development Revenue Bonds, Series 2014C (MSA Project)	09/03/2014	02/01/2029	2.000 – 5.000	9,700
Economic Development Revenue Bonds, Series 2014D Taxable (Pulliam Project)	09/03/2014	02/01/2029	5.000	3,320
Economic Development Revenue Bonds, Series 2019A (16 Tech)	08/06/2019	02/01/2040	3.000 – 5.000	28,585
Economic Development Revenue Refunding Bonds, Series 2021 A (CityWay 1)	04/22/2021	02/01/2036	5.000	72,950
Economic Development Revenue Refunding Bonds, Series 2021 B Taxable (CityWay 1)	04/22/2021	02/01/2024	1.000	115
Economic Development Revenue Bonds, Series 2022 B (Elanco)	02/24/2022	02/01/2047	4.000 – 5.000	<u>112,525</u>
Total Tax Increment Revenue Bonds				<u>505,950</u>

**Direct Borrowings and Direct Placement Bonds:**

*These bonds are issued directly to a small number of investors rather than as a public offering.*

Redevelopment District Bonds, Series 2007 (Ameriplax)	12/28/2007	02/01/2023	6.200	515
Redevelopment District Bonds, Series 2010A	06/03/2010	02/01/2025	5.000	1,598
Redevelopment District Bonds, Series 2010 (AIT Laboratories)	11/04/2010	02/01/2035	2.600 – 5.150	3,665
Redevelopment District Refunding Bonds, Series 2015A (Brokenburr Project)	08/06/2015	02/01/2030	3.250	894
Redevelopment District Project and Refunding Bonds, Series 2020B (Infosys Project)	03/01/2020	01/15/2025	0.930	22,200
Redevelopment District Bonds, Series 2020C Taxable (Infosys Project)	03/01/2020	01/15/2023	1.580	2,200
Redevelopment District Refunding Bonds, Series 2022 A	11/03/2022	02/01/2030	3.280	26,190
Economic Development Revenue Bonds, 2015A (Broad Ripple Project)	05/20/2015	02/01/2025	2.250	2,889
Economic Development Revenue Bonds, Series 2022 D (16 Tech Project)	06/30/2022	02/01/2039	3.770	19,530
Economic Development Refunding Revenue Bonds, Series 2022 C	11/03/2022	02/01/2030	3.280	16,350

Continued...

**CITY OF INDIANAPOLIS**  
**(A Component Unit of the Consolidated City of Indianapolis – Marion County)**  
Notes to Financial Statements  
December 31, 2022  
(Dollars in Thousands)

<u>Developer Backed Bonds</u>	<u>Issue Date</u>	<u>Final Maturity Date</u>	<u>Interest (All Maturities)</u>	<u>Outstanding</u>
Economic Development Tax Increment Revenue Bonds, Series 2017 (Bethel AME Project)	09/19/2017	02/01/2042	5.500	7,620
Economic Development Revenue Bonds, Series 2018 (Phoenix Theatre Project)	05/15/2018	02/01/2040	3.610 – 4.500	4,245
Economic Development Tax Increment Revenue Bonds, Series 2018 (Goodwill Riverview Project)	05/25/2018	01/15/2043	5.000	4,034
Economic Development Tax Increment Revenue Bonds, Series 2018 (River House Broad Ripple Project)	06/07/2018	01/15/2040	5.000	2,492
Economic Development Tax Increment Revenue Bonds, Series 2018 (Duke Headquarters Project-Draw Bonds)	06/28/2018	01/15/2043	4.000	2,867
Economic Development Tax Increment Revenue Bonds, Series 2018 (Ardmore Project- Draw Bonds)	11/30/2018	01/15/2043	5.000	7,200
Economic Development Tax Increment Revenue Bonds, Series 2018 (Ford Assembly Plant Project)	12/11/2018	01/15/2043	4.300	3,624
Economic Development Tax Increment Revenue Bonds, Series 2019 ( PR Mallory Building Project)	09/01/2019	01/15/2027	5.995	12,275
Economic Development Tax Increment Revenue Bonds, Series 2019 (City's End Project)	11/01/2019	01/15/2044	4.500	3,435
Economic Development Tax Increment Revenue Bonds, Series 2020 A (Block 20 Development Project)	01/07/2020	02/01/2044	5.000	4,562
Economic Development Tax Increment Revenue Bonds, Series 2020 (421 N Penn Project-Draw Bonds)	08/31/2020	01/15/2045	6.500	—
Economic Development Tax Increment Revenue Bonds, Series 2021 (Midtown Project)	05/17/2021	01/15/2041	3.500	3,286
Economic Development Tax Increment Revenue Bonds, Series 2021 (Rise on Meridian Project-Draw Bonds)	11/30/2021	02/01/2046	8.000	360
Economic Development Tax Increment Revenue Bonds, Series 2021 (Glendale II Project-Draw Bonds)	12/09/2021	08/01/2046	5.000	—
Economic Development Tax Increment Revenue Bonds, Series 2021 (Elevator Hill Phase I Project-Draw Bonds)	12/14/2021	02/01/2046	4.000	—
Economic Development Tax Increment Revenue Bonds, Series 2022 A (Indy Penn Center Hotel Garage Project)	02/01/2022	02/01/2042	2.310	18,225
Economic Development Tax Increment Revenue Bonds, Series 2022 A (Federally Taxable - Stutz 1 Project)	08/11/2022	02/01/2047	6.500	—
Economic Development Tax Increment Revenue Bonds, Series 2022 B (Federally Taxable - Stutz 1 Project)	08/11/2022	02/01/2047	6.500	—
Total direct borrowings and direct placement				<u>170,256</u>
Total tax increment revenue bonds (direct and public offerings)				676,206
Less: Matured bonds payable recorded in the debt service funds				<u>(5,902)</u>
				<u>\$ 670,304</u>

All principal and interest payments for the City’s tax increment revenue bonds are due on January 15 and July 15 or February 1 and August 1 of the respective year.

All TIF debt listed above except for the Redevelopment District, Series 1999B and the Redevelopment District Refunding Bonds, Series 2014 have pledges of all proceeds of the Trust Estate. Of the direct borrowing and direct placement TIF bonds, the Redevelopment District Bonds, 2007; Economic Development Revenue Bonds, Series 2015A (Broad Ripple Project); Economic Development Tax Increment Revenue Bonds, Series 2020A (Block 20 Development Project), Economic Development Tax Increment Revenue Bonds, Series 2020 (421 N Penn Project-Draw Bonds), Economic Development Tax Increment Revenue Bonds, Series 2021 (Rise on Meridian Project-Draw Bonds), Economic Development Tax Increment Revenue Bonds, Series 2021 (Glendale II Project-Draw Bonds), Economic Development Tax Increment Revenue Bonds, Series 2021 (Elevator Hill Phase I Project-Draw Bonds), Economic Development Tax Increment Revenue Bonds, Series 2022D (16 Tech Project), Economic Development Tax Increment Revenue Bonds, Series 2022A&B (Federally Taxable – Stutz 1 Project), Redevelopment District Refunding Bonds, Series 2022A, and Economic Development Tax Increment Refunding Revenue Bonds, Series 2022B have pledges of all proceeds of the Trust Estate. Following an event of default on the Economic Development Tax Increment Revenue Bonds, Series 2020A (Block 20 Development Project) Bonds, the trustee may declare the principal and accrued interest on all bonds to be due and payable immediately. Following an event of default on the Economic Development Tax Increment Revenue Bonds, Series 2021 (Rise on Meridian Project-Draw Bonds), the Economic Development Tax Increment Revenue Bonds, Series 2021 (Elevator Hill Phase I Project-Draw Bonds), the Economic Development Tax Increment Revenue Bonds, Series 2022D (16 Tech Project), and the Economic Development Tax Increment Revenue Bonds, Series 2022A&B (Federally Taxable – Stutz 1 Project) the trustee may pursue any available remedy by suit at law or in equity to enforce the payment of the principal and accrued interest. Following an event of default on the Economic Development Tax Increment Revenue Bonds, Series 2021 (Glendale II Project-Draw Bonds), the non-defaulting party, at its option and with any prior notice required hereunder, may institute any action, suit, or other proceeding at law or in equity which it shall deem necessary or proper for the protection of its interests.

On February 24, 2022, the City issued its Economic Development Tax Increment Revenue Bonds, Series 2022B (Elanco) in the amount of \$112,525. The proceeds will be used to acquire, construct, and equip facilities related to Elanco US, Inc., redevelopment and operation of a new global headquarters in the City, and related infrastructure improvements located on approximately 39 acres of a larger 91-acre site, commonly known as the former GM Stamping Plant. The proceeds will also affect a current refunding on the Indianapolis Local Improvement

**CITY OF INDIANAPOLIS**  
**(A Component Unit of the Consolidated City of Indianapolis – Marion County)**  
Notes to Financial Statements  
December 31, 2022  
(Dollars in Thousands)

Bond Bank’s Series 2011 F bonds. While the refunding was not completed at the qualified entity level, the savings related to the refunding will be passed along to the City. The bonds mature on February 1, 2047 and have interest rates of 4.00%-5.00%.

On June 30, 2022, the City issued its Economic Development Tax Increment Revenue Bonds, Series 2022 D (16 Tech Project) in the amount of \$19,530. The proceeds will be used to pay for the costs of construction of the 16 Tech Project, and pay all costs incidental to, or on account of the issuance of the 2022 Bonds. The proceeds will also be placed into a debt service reserve fund. The bonds mature on February 1, 2039 and have an interest rate of 3.77%.

On November 3, 2022, the City issued its Redevelopment District Refunding Bonds, Series 2022A in an amount of \$26,190. The proceeds will be used to effectuate a current refunding of the Redevelopment District Tax Increment Refunding Bonds of 2013, Series A and the Redevelopment District Tax Increment Bonds of 2013, Series A. The refunding resulted in an accounting gain of \$1,606, which has been deferred and is being amortized over the life of the bonds. As a result of the refunding, the City reduced its total debt service requirements by \$4,102, which resulted in an economic gain (the difference between the present values of the debt service payments on the old and new debt) of \$2,145. The bonds mature on February 1, 2030 and have an interest rate of 3.28%.

On November 3, 2022, the City issued its Economic Development Tax Increment Refunding Revenue Bonds, Series 2022C in an amount of \$16,350. The proceeds will be used to effectuate a current refunding of the Economic Development Tax Increment Revenue Bonds, Series 2013 A and B. The refunding resulted in an accounting gain of \$978, which has been deferred and is being amortized over the life of the bonds. As a result of the refunding, the City reduced its total debt service requirements by \$1,992, which resulted in an economic gain (the difference between the present values of the debt service payments on the old and new debt) of \$1,527. The bonds mature on February 1, 2030 and have an interest rate of 3.28%.

**Developer Backed Bonds**

On February 1, 2022, the City issued its Economic Development Tax Increment Bonds, Series 2022 A (Indy Penn Center Hotel Garage Project), in the amount of \$18,225. The proceeds, together with a cash contribution was used to redeem the City’s outstanding Economic Development Tax Increment Revenue Bond Anticipation Note, Series 2017, in the amount of \$17,895. The bonds mature on February 1, 2042 and have an interest rate of 2.31%.

On August 11, 2022, the City issued its Economic Development Tax Increment Revenue Bonds, Series 2022A (Federally Taxable – Stutz 1 Project) and its Economic Development Tax Increment Revenue Bonds, Series 2022B (Federally Taxable – Stutz 1 Project) in the amounts of \$9,000 and \$3,321, respectively. The proceeds will be used to provide the Developer with funds to finance the redevelopment, construction, and equipping of the existing Stutz Factory Building into a mixed-use facility consisting of approximately 12,000 square feet of retail and dining space, approximately 27,000 square feet of coworking space, approximately 17,000 square feet of event space, and approximately 15,000 square feet of fitness/lifestyle space, located at 1060 North Capitol Avenue in the City. The bonds are draw bonds, and as of December 31, 2022 no draws have been made. The interest rate for these bonds is 6.50%.

Annual debt service requirements to maturity for the tax increment revenue bonds are as follows:

Years Ending December 31	Publicly Issued		Direct Borrowings and Direct Placements		Total	
	Principal	Interest	Principal	Interest	Principal	Interest
2023	\$ 42,485	\$ 15,828	\$ 14,106	\$ 5,246	\$ 56,591	\$ 21,074
2024	45,520	15,089	13,880	5,563	59,400	20,652
2025	43,730	14,340	8,335	5,351	52,065	19,691
2026	45,540	13,610	2,789	5,232	48,329	18,842
2027	46,360	12,819	15,195	4,805	61,555	17,624
2028-2032	148,050	48,779	60,659	16,022	208,709	64,801
2033-2037	86,075	23,714	28,431	8,415	114,506	32,129
2038-2042	37,545	10,515	24,262	2,798	61,807	13,313
2043-2047	35,690	3,681	2,599	93	38,289	3,774
	530,995	158,375	170,256	53,525	701,251	211,900
Less: deferred interest on capital appreciation bonds	(25,045)	—	—	—	(25,045)	—
Total	\$ 505,950	\$ 158,375	\$ 170,256	\$ 53,525	\$ 676,206	\$ 211,900



**CITY OF INDIANAPOLIS**  
**(A Component Unit of the Consolidated City of Indianapolis – Marion County)**  
Notes to Financial Statements  
December 31, 2022  
(Dollars in Thousands)

**D. Revenue Bonds**

The City also issues revenue bonds where the City pledges income derived from the acquired or constructed assets to pay debt service. At December 31, 2022, these include:

	<u>Issue Date</u>	<u>Final Maturity Date</u>	<u>Interest (All Maturities)</u>	<u>Outstanding</u>
Economic Development Refunding Bonds, Series 2012A	12/20/2012	04/01/2030	0.600 – 3.000	\$ 3,965
Economic Development Refunding Bonds, Series 2012B	12/20/2012	04/01/2039	2.000 – 5.000	14,115
Stormwater District Revenue Refunding Bonds, Series 2013	10/16/2013	01/01/2026	2.000 – 5.000	13,335
Indy Roads Revenue Bond, Series 2015A	03/25/2015	01/01/2035	3.000 – 5.000	3,680
Indy Roads Revenue Bonds, Series 2015B	09/16/2015	01/01/2035	3.000 – 5.000	5,205
PILOT Refunding Bonds, Series 2017C	12/28/2017	01/01/2040	4.000 – 5.000	138,020
Indy Roads Revenue Bond, Series 2018A	12/18/2018	01/01/2039	4.000 – 5.000	855
Stormwater District Revenue Bonds, Series 2019	10/16/2019	01/01/2041	4.000 – 5.000	50,000
Indy Roads Revenue Bonds, Series 2019A	09/19/2019	01/01/2040	5.000	7,810
Stormwater District Revenue Refunding Bonds, Series 2022A	02/24/2022	01/01/2052	4.000 - 5.000	<u>50,000</u>
Total revenue bonds				286,985
<b>Direct Borrowings and direct placements:</b>				
Stormwater District Revenue Bonds, Series 2011	08/10/2011	01/01/2041	3.580	<u>11,885</u>
Total direct revenue bonds				<u>11,885</u>
Total revenue bonds recorded in governmental activities (direct and public)				298,870
Less matured bonds payable recorded in debt service funds				<u>—</u>
				<u>\$ 298,870</u>

All principal and interest payments for the City’s revenue bonds are due on January 1 and July 1, January 15 and July 15, or April 1 and October 1 of the respective year. Accordingly, the City appropriates all payments due on January 1 and January 15 in the year before payment is due and provides the amount in the Debt Service Funds. Payments due in April, July, or October will be appropriated in the year due. All revenue bond principal and interest payments due January 1, 2023 and January 15, 2023 have been recorded as matured bonds payable and matured interest payable at December 31, 2022.

On February 24, 2022, the City issued its Stormwater District Revenue Bonds, Series 2022A in the amount of \$50,000. The proceeds will be used to affect a current refunding of the Stormwater District Revenue Notes, Series 2019, pay for all or a portion of the costs of certain additions and improvements to the Stormwater District’s Stormwater System, and pay all costs incidental to, or on account of the issuance of the 2022 Bonds. The bonds mature on January 1, 2052 and have interest rates of 4.00%-5.00%.

All revenue bonds except the Stormwater District Revenue Bonds, Series 2011, have pledges of all proceeds of the Trust Estate.

**CITY OF INDIANAPOLIS**  
**(A Component Unit of the Consolidated City of Indianapolis – Marion County)**  
Notes to Financial Statements  
December 31, 2022  
(Dollars in Thousands)

Revenue bond debt service requirements to maturity are as follows:

Years Ending December 31	Publicly Issued		Direct Borrowings and Direct Placements		Total	
	Principal	Interest	Principal	Interest	Principal	Interest
2023	\$ 760	\$ 7,229	\$ —	\$ 251	\$ 760	\$ 7,480
2024	15,645	13,240	460	493	16,105	13,733
2025	16,385	12,490	480	474	16,865	12,964
2026	14,620	11,766	500	454	15,120	12,220
2027	11,905	11,113	520	434	12,425	11,547
2028-2032	63,820	46,277	2,930	1,833	66,750	48,110
2033-2037	76,610	29,416	3,565	1,185	80,175	30,601
2038-2042	62,050	10,772	3,430	349	65,480	11,121
2043-2047	11,240	4,647	—	—	11,240	4,647
2048-2052	13,950	1,812	—	—	13,950	1,812
Total	\$ 286,985	\$ 148,762	\$ 11,885	\$ 5,473	\$ 298,870	\$ 154,235

At December 31, 2022, \$322,870 of defeased revenue bonds remain outstanding and have been removed from the basic financial statements.

**E. Pledged Revenues**

The City has pledged specific revenue to secure the repayment of outstanding debt issues. The following table lists those revenues and the corresponding debt issue along with the purpose of the debt, the amount of the pledge remaining, the term of the pledge commitment, the current fiscal year principal and interest on debt, and the amount of pledged revenue collected during the current fiscal year:

Revenue Bond Issue	General Purpose for Debt	Term of Commitment	Pledged Revenue	Principal and Interest for Fiscal Year Ended December 31, 2022	Pledged Revenues for Fiscal Year Ended December 31, 2022	Total Principal and Interest Remaining on Debt
Tax increment revenue	Infrastructure improvements and certain economic development projects	Through 2044	Property tax increment	\$ 85,867	\$ 130,601	\$ 929,217 (a)
Transportation revenue	Construction, reconstruction, and repair of roads, streets, and sidewalks	Through 2040	Wheel tax and gasoline tax	5,594	86,698	19,912
Stormwater	Improvements of stormwater handling capabilities	Through 2041	Net revenues of the stormwater system	10,341	12,927	202,552
Economic development	Provide financial incentives and assistance to a private developer for the construction of a downtown hotel and purchase of a parking garage	Through 2039	Parking garage fees	1,579	1,579	26,395
PILOT	Construction of certain improvements to the City's public roads, street and sidewalks, and other public facilities	Through 2040	Payments in lieu of taxes	12,084	20,152	205,526

(a) This amount excludes debt related to certain economic development projects for which the developer is responsible for making the debt service payments.

**CITY OF INDIANAPOLIS**  
**(A Component Unit of the Consolidated City of Indianapolis – Marion County)**  
Notes to Financial Statements  
December 31, 2022  
(Dollars in Thousands)

---

**F. Notes Payables**

1. On October 8, 2010, the City entered into an agreement with Fifth Third Leasing Company to issue notes in the amount of \$18,800. The proceeds were used to complete energy improvements at various City owned properties. The notes are payable over a 15-year period beginning on January 1, 2013 and fully mature on July 31, 2027. The stated interest rate is 3.23%. The provision of the note agreement guarantees that the City will realize sufficient energy savings to fully cover the note's debt service. The outstanding balance of the notes at December 31, 2022 is \$7,709.
2. On December 30, 2015, the MDC and CAC entered into an agreement with a developer to construct phase II of the project known as CityWay. CAC entered into a loan agreement for \$18,250 in order to make the loan to the developer. Under the terms of the agreement, the interest payments are due each January 15 and July 15 and the stated interest rate is 3.89%. At December 31, 2022, the CAC has recorded \$744 of cash in escrow and long-term debt of \$14,180. Included in the cash balance is \$744 in a continuing reserve. These amounts will be used to make the debt service payments until the balance in the continuing reserve reaches \$745, after which the developer will make the balance of the payment for the debt service. The City will grant amounts to CAC to repay the loan from existing Certified Technology Park revenues, tax increment financing revenues on the project property and payments from the developer. If such amounts are insufficient to repay the debt the City will pay the difference from excess tax increment financing revenues.
3. In 2013, the City was awarded a \$39,000 Section 108 Loan to create the Community & Economic Development Loan Program (CEDLP). The City will loan these funds to entities with eligible projects for economic development and housing development activities to benefit low to moderate income individuals. Section 108 provides communities with a source of financing for economic development, housing rehabilitation, public facilities, and large-scale physical development projects or to aid in the prevention of slums.
4. On March 31, 2016, the City loaned the Meadows Community Foundation \$1,600; the loan will mature on March 31, 2036. Principal payments are due annually and interest payments are due quarterly. The City will use the payments received from Meadows Community Foundation to repay the loan to HUD. The outstanding balance of the note at December 31, 2022 is \$255.
5. On October 20, 2017, the City loaned Ford TWG, LLC (Ford) \$4,650; the loan will mature on August 1, 2037. Principal payments are due annually and interest payments are due quarterly. The City will use the payments received from Ford to repay the loan to HUD. At December 31, 2022, the long-term receivable and the outstanding balance of the note is \$4,650.
6. On August 15, 2018, the City borrowed funds for the Monon16 Project in the amount of \$5,000; the loan was scheduled to mature on August 1, 2038. However, a partial prepayment was made on February 26, 2019 as part of a refinancing agreement, and now the loan is scheduled to mature on August 1, 2029. Under the new amortization schedule, principal payments are due annually and interest payments are due semiannually. At December 31, 2022, the outstanding balance of the note is \$1,908. The funds will be used to develop the "Monon16" area, which is the immediate area surrounding the intersection of the Monon Trail and 16th Street. This includes housing, security, and transportation improvements.
7. On September 14, 2018, the City borrowed funds for the Central State Complex Project in the amount of \$4,575; the loan will mature on August 1, 2038. Principal payments are due annually and interest payments are due quarterly. At December 31, 2022, the outstanding balance of the note is \$4,575. The funds will be used to develop the Central State Complex, which is a growing neighborhood on the near Westside of Indianapolis. This includes infrastructure, housing, and education improvements.
8. On August 1, 2020, the City borrowed funds for the Near South Meridian Project in the amount of \$1,250, though a total of \$5,000 was authorized. The loan will mature on August 1, 2039. Principal payments are due annually and interest payments are due quarterly. At December 31, 2022, the outstanding balance of the note is \$5,000 as this is a draw note. The funds will be used to develop the near Southside, which is a developing area of Indianapolis. This includes infrastructure, housing, and education improvements.
9. On August 10, 2017, the City issued Economic Development Tax Increment Revenue Bond Anticipation Note, Series 2017 (Indy Penn Center Hotel Garage Project) in the amount of \$17,895. The proceeds are being used to fund a portion of the Indy Penn Center Hotel Garage Project, as well as to pay interest and the costs of issuance of the bond anticipation note. This note has a maturity date of February 1, 2022. The notes were fully paid off as of December 31, 2022.
10. On December 14, 2018, the City issued Economic Development Tax Increment Revenue Bond Anticipation Note, Series 2018 (ILMAR/KG 220 Projects) in the amount of \$15,855. The proceeds are being used to fund a portion of the costs of constructing improvements to a historic building in connection with the development of the building by ILMAR, LLC into a high-end hotel, to fund constructing improvements to a building in connection with the development of the building by KG 220 LLC into a mixed-use office, commercial retail, and residential development, and to finance capitalized interest and the costs of issuance of the bond anticipation note. The bonds are secured by a Junior-Junior Subordinate line of Consolidated TIF revenues, regarding interest payments only, and a developer guarantee. Once the BAN is refunded by the long-term debt obligation, both principal and interest, is

**CITY OF INDIANAPOLIS**  
**(A Component Unit of the Consolidated City of Indianapolis – Marion County)**  
Notes to Financial Statements  
December 31, 2022  
(Dollars in Thousands)

expected to be paid from the TIF revenues generated by the project, and to the extent project TIF revenues are not sufficient, the Consolidated TIF revenues. On October 12, 2022, the City extended the maturity of the note to December 14, 2023 at a fixed interest rate of 5.42% from an original maturity date of February 1, 2023.

11. On March 5, 2019, the City issued its Series 2019 Stormwater Notes in the amount of \$50,000. The proceeds will be used for infrastructure improvements, including new channels, culverts, dam renovations, engineering studies, and drainage and water quality improvements. This note has a maturity date of March 1, 2022. The notes were fully paid off as of December 31, 2022.
12. On July 12, 2019, the City issued Taxable Economic Development Tax Increment Revenue Note, Series 2019 A in the amount of \$30,000. Pursuant to an agreement with The Dow Chemical Company and E.I. du Pont de Nemours and Company, which merged into a new company, DowDuPont on August 31, 2017, DowDuPont separated their leading businesses into three independent, publicly traded companies, one of which will be a leading, global pure-play agricultural business, Corteva Agriscience (“Corteva”). Effective June 1, 2019, Corteva completed its separation from DowDuPont and as part of the agreement, Corteva will retain its global business center and research and development facilities in the City. The note proceeds will provide reimbursement for prior payment of, all or any portion of the costs of the continued operations of, and any additions or improvements to and equipment for, the existing global business center and research and development facilities, which will retain approximately 1,385 full-time jobs in the City. The note will mature on February 20, 2026 and bears interest at 3.35%. The outstanding balance of the notes at December 31, 2022 is \$11,304. The issuance of this note did not provide a source of current financial resources since no cash was received, and it does not affect the near-term liquidity of the City.
13. On November 10, 2021, the City issued its Series 2021 Stormwater Notes in the amount of \$50,000. The proceeds will be used for infrastructure improvements, including new channels, culverts, dam renovations, engineering studies, and drainage and water quality improvements. This note has a maturity date of November 1, 2024 and the last draw of the commitment amount must occur by March 30, 2024. The outstanding balance of the notes at December 31, 2022 is \$1,083, as this is a draw note.
14. On February 15, 2022, the City executed a public-private build-operate-transfer agreement with Garmong & Son, Inc. in amount not to exceed \$36,075 for the design, construction, and financing of a judicial and professional building parking garage, located at the Community Justice Campus. The installment purchase agreement matures on January 30, 2027 and has a balloon principal payment of \$33,000 due on that date, interest is due annually at a rate of 1.9%. The outstanding balance at December 31, 2022 is \$25,386, which represents the cost of the construction for the garages as of year-end.

Annual amounts due on notes payable to maturity are as follows:

<u>Years Ending</u>	<u>Governmental Activities</u>	
<u>December 31</u>	<u>Principal</u>	<u>Interest</u>
2023	\$ 21,636	\$ 3,064
2024	7,016	1,896
2025	7,825	1,600
2026	6,631	1,363
2027	26,468	1,205
2028-2032	10,968	1,700
2033-2037	9,836	457
2038-2042	1,525	10
Total	<u>\$ 91,905</u>	<u>\$ 11,295</u>

**CITY OF INDIANAPOLIS**  
**(A Component Unit of the Consolidated City of Indianapolis – Marion County)**  
Notes to Financial Statements  
December 31, 2022  
(Dollars in Thousands)

---

**G. Lease Liabilities**

The City, as lessee, leases equipment, vehicles, and office space, which have an underlying right to use asset category of buildings and equipment as reported in the Statement of Net Position and Note 9. The terms of the agreements expire in various years from 2023 through 2051. Payments for the leased items are fixed in all cases. During the year ended December 31, 2022, the City recognized \$0 for variable payments.

The following is a schedule by year of payments under the leases as of December 31, 2022:

<u>Years Ending December 31</u>	<u>Governmental Activities</u>		
	<u>Total</u>	<u>Principal</u>	<u>Interest</u>
2023	\$ 11,447	\$ 10,196	\$ 1,251
2024	10,108	9,172	936
2025	7,852	7,155	697
2026	6,879	6,330	549
2027	3,606	3,167	439
2028-2032	7,791	6,453	1,338
2033-2037	3,911	3,438	473
2038-2042	110	70	40
2043-2047	109	87	22
2048-2051	66	63	3
Total	<u>\$ 51,879</u>	<u>\$ 46,131</u>	<u>\$ 5,748</u>

**CITY OF INDIANAPOLIS**  
**(A Component Unit of the Consolidated City of Indianapolis – Marion County)**  
Notes to Financial Statements  
December 31, 2022  
(Dollars in Thousands)

**H. Financed Purchase Obligations**

The City leases vehicles and equipment through agreements, which management has determined to be financed purchase obligations due to the terms related to transfer of ownership at the end of the agreement.

1. On July 13, 2022, the City entered into a financed purchase obligation with JP Morgan Chase Bank in the amount of \$10,283. The proceeds will be used to purchase pursuit vehicles for the police department. The outstanding balance at December 31, 2022 is \$9,456 and matures on June 1, 2028. The stated interest rate is 2.56%. At December 31, 2022, the City has recorded \$10,275 of cash in escrow related to the finance purchase obligation.
2. On November 18, 2022, the City entered into a financed purchase obligation with JP Morgan Chase Bank in the amount of \$22,473. The proceeds were used to purchase fire apparatus vehicles for the fire department. The stated interest rate is 3.62%. The outstanding balance at December 31, 2022 is \$22,473 and matures on September 1, 2030.

The following schedule by year represents the finance purchase obligation payments as of December 31, 2022:

Years Ending December 31	Governmental Activities		
	Total	Principal	Interest
2023	\$ 5,336	\$ 4,079	\$ 1,257
2024	5,337	4,448	889
2025	5,338	4,593	745
2026	5,338	4,742	596
2027	5,338	4,897	441
2028-2030	9,635	9,170	465
Total	\$ 36,322	\$ 31,929	\$ 4,393

**I. Other Long-Term Liabilities**

1. Postemployment Benefit Obligation: As discussed later in these notes, the City provides postemployment healthcare benefits for police officers and firefighters. Civilian employees may continue healthcare coverage but are required to contribute 100% of their annual premium.
2. Net Pension Liabilities: As discussed later in these notes, the City’s single employer pension plans are funded on a “pay-as-you-go” basis.
3. Early Retirement Obligation: On October 12, 2020, the City County Council passed Amended Proposal No. 298, which authorized an elective retirement option for employees. Early retirement benefits included a \$10 lump sum payment paid during the first month of retirement, and 75% of the retiree’s base salary at the time of retirement paid during the retiree’s regular pay cycle for 12 months following their retirement date. The program was capped at 190 City and County employees, with preference based on age plus years of continuous service. A total of 88 City employees participated in the program for a total cost of \$4,634. At December 31, 2022, the remaining liability was \$0.
4. Compensated Absences Payable: A long-term liability for benefit and sick leave earned but not paid of \$41,428 at December 31, 2022 is recorded in the government-wide statements.

Other long-term liabilities are generally to be liquidated by the General Fund, with the exception of claims and judgments that are to be liquidated from the Risk Management Internal Service Fund.

**CITY OF INDIANAPOLIS**  
**(A Component Unit of the Consolidated City of Indianapolis – Marion County)**  
Notes to Financial Statements  
December 31, 2022  
(Dollars in Thousands)

**12. Conduit Debt**

From time to time, the City has issued Economic Development Revenue Bonds to provide financial assistance to private sector entities for the acquisition, rehabilitation, and construction of industrial, commercial, and housing facilities and projects deemed to be in the public interest. The bonds are secured by the property financed. The City is not obligated in any manner for repayment of these bonds. Accordingly, the bonds are not reported as liabilities in the accompanying financial statements.

The outstanding City conduit debt issued prior to 2001 cannot be determined. Currently outstanding as of December 31, 2022 are 16 series of Economic Development Revenue Bonds approved by the Council issued on or after 2001 for a total not-to-exceed amount of \$230,591. The aggregate principal amount outstanding at December 31, 2022 since 2001 is \$140,043.

**13. Fund Balances**

The following table displays the breakdown of fund balance by purpose in accordance with GASB Statement No. 54:

	General Fund	Coronavirus Federal Stimulus Fund	Revenue Bond Debt Service Fund	Redevelopment District Tax Increment Capital Project Fund	Nonmajor Governmental Funds	Total
<b>Nonspendable:</b>						
Permanent fund (principal and interest)	\$ —	\$ —	\$ —	\$ —	\$ 376	\$ 376
<b>Restricted for:</b>						
Street maintenance and projects	53,403	—	—	—	—	53,403
Stormwater management	38,343	—	—	—	—	38,343
Debt service	—	—	202,864	—	63,481	266,345
Capital projects	—	—	—	200,624	149,164	349,788
Other purposes by grantors	—	—	—	—	82,532	82,532
Sidewalk, curb and street repair	—	—	—	—	11,394	11,394
	<u>91,746</u>	<u>—</u>	<u>202,864</u>	<u>200,624</u>	<u>306,571</u>	<u>801,805</u>
<b>Committed to:</b>						
Capital projects	—	—	—	—	60,225	60,225
Utility monitoring	260	—	—	—	—	260
CJC	12,013	—	—	—	—	12,013
	<u>12,273</u>	<u>—</u>	<u>—</u>	<u>—</u>	<u>60,225</u>	<u>72,498</u>
<b>Assigned to:</b>						
Redevelopment	13,507	—	—	—	—	13,507
Solid waste collection	6,002	—	—	—	—	6,002
Parks and recreation	6,575	—	—	—	—	6,575
Other purposes	71,264	—	—	—	—	71,264
Public safety	7,854	—	—	—	—	7,854
	<u>105,202</u>	<u>—</u>	<u>—</u>	<u>—</u>	<u>—</u>	<u>105,202</u>
<b>Unassigned (deficit)</b>	<u>118,588</u>	<u>(1,312)</u>	<u>—</u>	<u>—</u>	<u>(8,952)</u>	<u>108,324</u>
<b>Total fund balance (deficit)</b>	<u>\$ 327,809</u>	<u>\$ (1,312)</u>	<u>\$ 202,864</u>	<u>\$ 200,624</u>	<u>\$ 358,220</u>	<u>\$ 1,088,205</u>

**CITY OF INDIANAPOLIS**  
**(A Component Unit of the Consolidated City of Indianapolis – Marion County)**  
Notes to Financial Statements  
December 31, 2022  
(Dollars in Thousands)

---

**14. Postemployment Benefits Other Than Pensions**

**A. Plan Description**

The City postemployment medical benefit plan (the OPEB Plan) is a single-employer defined benefit other postemployment benefit (OPEB) plan covering eligible retirees and their dependents, which is administered by the City for certain groups of beneficiaries and boards of trustees appointed by the local unions administering for other groups of beneficiaries. Benefit provisions are established through negotiations between the City and the union representing the City’s employees and are renegotiated each three-year bargaining period for certain groups of beneficiaries. Benefit provisions for certain other groups are determined by the board of trustees appointed by the local unions. The City determines benefits for non-union employees. The OPEB Plan does not issue a separate report that includes financial statements and required supplementary information for the OPEB Plan.

**B. Benefits Provided**

Civilian employees who are eligible for retirement may choose to continue their healthcare coverage on the City’s insurance plan until the age of 65 but are required to contribute 100% of their annual premium costs. By providing retirees with access to the City’s healthcare plans based on the same rates it charges to active employees, the City is in effect providing a subsidy to retirees. This implied subsidy exists because, on average, retiree healthcare costs are higher than active employee healthcare costs. By the City not contributing anything toward this plan in advance, the City employs a pay-as-you-go financing method through paying the higher rate for active employees each year.

For Police and Firefighter eligible retirees and their spouses, 60% of the cost of current year premiums are paid from the Retiree Health Insurance Fund (RHIF). Plan members receiving benefits contribute 40% of their premium costs. For Police and Firefighter eligible retirees over age 65, amounts determined by the board of trustees appointed by the local unions are contributed to the retiree towards the premium cost of a Medicare Supplement plan.

Eligible retirees must meet the following criteria:

**Civilian**

1. At age 65 and has at least 10 years of creditable service, or
2. At age 60 with at least 15 or more years of creditable service, or
3. If the member’s age in years plus the years of creditable service equal at least 85 and the member is at least 55 years of age.

**Police**

1. At least 20 years of service, who are over the age of 52, and less than age 65.

**Firefighters**

1. At least 20 years of service, who are at least age 52, and less than age 65.

The employees covered by the OPEB Plan benefit terms at the valuation date of January 1, 2021 (valuation date), are:

	<b>2021</b>
Active Employees	4,040
Retired Employees	761
Beneficiaries	51
Spouses of Retired Employees	131
	4,983



**CITY OF INDIANAPOLIS**  
**(A Component Unit of the Consolidated City of Indianapolis – Marion County)**  
Notes to Financial Statements  
December 31, 2022  
(Dollars in Thousands)

---

**C. Contributions**

Contribution requirements are negotiated between the City and union representatives. For fiscal year 2022, the City contributed \$8,003 to the plan. Any cash balance left at the end of the calendar year in the RHIF is transferred to the trusts for the benefit of the retired Police and Firefighter employees.

**D. Net OPEB Liability**

The City’s net OPEB liability of \$215,784 was measured as of December 31, 2022, for the year ended December 31, 2022, and the total OPEB liability used to calculate the net OPEB liability was determined by an actuarial valuation as of January 1, 2021. The total OPEB liability was calculated based on the discount rate and actuarial assumptions below and was then rolled forward to the measurement date. Any significant changes during this period have been reflected as prescribed by GASB Statement No. 74 and No. 75.

The total OPEB liability in the January 1, 2021, actuarial valuation was determined using the following actuarial assumptions, applied to all periods included in the measurement:

Inflation	2.20% for 15 years and 2.50% thereafter
Salary Increases	2.75% average, including inflation
Health Care Cost Trend Rates	5.10% - 3.80% over 54 years
Discount Rate	3.72%

Mortality rates for police and fire were determined using the PubS-2010 Mortality Table for Employees and Healthy Annuitants with generational projections of future improvements per the MP-2019 Ultimate scale. This assumption includes a margin for improvements in longevity beyond the valuation date. All other members were determined using the PubG-2010 Mortality Table for Employees and Healthy Annuitants with generational projections of future improvements per the MP-2019 Ultimate scale. This assumption includes a margin for improvements in longevity beyond the valuation date.

The plan has not had a formal actuarial experience study performed for the January 1, 2021 valuation. Total OPEB liability was calculated using the previously established actuarial assumptions.

The long-term expected rate of return on the OPEB Plan investments of 3.72% was determined by adding expected inflation to expected long-term real returns and reflecting expected volatility and correlation. The capital market assumptions are per the actuary’s investment consulting practice as of December 31, 2022. The assets held in the OPEB trusts are not included in the information presented in Note 2, *Cash Deposits and Investments*, or Note 3, *Disclosures About Fair Value of Assets*.

Asset Class	Target Allocation	Long-Term Expected	Long-Term Expected
		Arithmetic Real Rate of Return	Geometric Real Rate of Return
U.S. Cash	1.00%	-0.26%	-0.26%
U.S. Core Fixed Income	75.00%	1.39%	1.28%
U.S. Municipal Bonds	14.00%	0.60%	0.50%
U.S. Broad Equity Market	10.00%	5.17%	3.57%
	<u>100.00%</u>		

**E. Discount Rate**

The discount rate used to measure the total OPEB liability was 3.72% for the year ended December 31, 2022. The projection of cash flows used to determine the discount rate assumed that City contributions will be made at rates equal to the actuarially determined contribution rates. Based on those assumptions, the OPEB Plan’s fiduciary net position was projected to be available to make all projected OPEB payments for current active and inactive employees. Therefore, the long-term expected rate of return on OPEB Plan investments was applied to all periods of projected benefit payments to determine the total OPEB liability.

**CITY OF INDIANAPOLIS**  
**(A Component Unit of the Consolidated City of Indianapolis – Marion County)**  
Notes to Financial Statements  
December 31, 2022  
(Dollars in Thousands)

**F. Changes in the Net OPEB Liability**

Changes in the total OPEB liability, OPEB Plan fiduciary net position and the net OPEB liability are:

	<b>2022</b>		
	Total OPEB Liability (a)	OPEB Plan Fiduciary Net Position (b)	Net OPEB Liability (a)-(b)
Balance, beginning of year	\$ 260,240	\$ 14,633	\$ 245,607
Changes for the year:			
Service Cost	14,077	-	14,077
Interest on total OPEB liability	5,571	-	5,571
Effect of assumptions changes or inputs	(42,055)	-	(42,055)
Benefit payments	(7,764)	(7,764)	-
Employer contributions	-	8,003	(8,003)
Net investment income	-	(516)	516
Administrative expense	-	(71)	71
	(30,171)	(348)	(29,823)
Net Changes			
Balance, end of year	\$ 230,069	\$ 14,285	\$ 215,784

Changes of assumptions reflect a change in the discount rate from 2.06% at December 31, 2021 to 3.72% at December 31, 2022.

**G. Sensitivity of the Net OPEB Liability to Changes in the Discount Rate and Healthcare Cost Trend Rates**

The net OPEB liability of the City has been calculated using a discount rate of 3.72%. The following presents the net OPEB liability using a discount rate 1% higher and 1% lower than the current discount rate.

	1% Decrease	Discount Rate	1% Increase
City's net OPEB liability	\$ 239,901	\$ 215,784	\$ 194,763

The net OPEB liability of the City has been calculated using current healthcare cost trend rates. The following presents the net OPEB liability using healthcare cost trend rates 1% higher and 1% lower than the current health care cost trend rates.

	1% Decrease	Current Trend Rates	1% Increase
City's net OPEB liability	\$ 186,171	\$ 215,784	\$ 251,673

**CITY OF INDIANAPOLIS**  
**(A Component Unit of the Consolidated City of Indianapolis – Marion County)**  
Notes to Financial Statements  
December 31, 2022  
(Dollars in Thousands)

---

**H. OPEB Expense and Deferred Outflows of Resources and Deferred Inflows of Resources Related to OPEB**

For the year ended December 31, 2022, the City recognized OPEB expense of \$10,419. At December 31, 2022, the City reported deferred outflows of resources and deferred inflows of resources related to OPEB from the following sources:

	<b>2022</b>	
	Deferred Outflows of Resources	Deferred Inflows of Resources
Differences between expected and actual experience	\$ -	\$ 24,477
Changes of assumptions	24,356	55,407
Net difference between projected and actual earnings on OPEB plan investments	631	-
Total	\$ 24,987	\$ 79,884

Amounts reported as deferred outflows of resources and deferred inflows of resources at December 31, 2022, related to OPEB will be recognized in OPEB expense as follows:

2023	\$	(9,054)
2024		(9,077)
2025		(9,021)
2026		(7,097)
2027		(8,521)
Thereafter		(12,127)
	\$	(54,897)

**I. Payable to the OPEB Plan**

At December 31, 2022, the City reported a payable of \$148, for the outstanding amount of contributions to the OPEB Plan required for the year ended December 31, 2022.

**CITY OF INDIANAPOLIS**  
**(A Component Unit of the Consolidated City of Indianapolis – Marion County)**  
Notes to Financial Statements  
December 31, 2022  
(Dollars in Thousands)

---

**15. Pension Plans**

**A. Plan Descriptions, Funding Policies, Benefits, and Contribution Information**

**1. 1953 Police Pension Fund and 1937 Firefighters’ Pension Fund**

*Description of Plans*

The City maintains two single-employer defined benefit pension plans covering police officers and firefighters hired on or before April 30, 1977 (“Police and Firefighters’ Pre-1977 Plans”), which are funded on a pay-as-you-go basis. The plans were established in accordance with IC 36-8-7.5 and 36-8-7, respectively, and are administered by the City. State statute grants authority for these pension plans and sets the regulations covering benefits. No separately issued financial statements are available and the plans are closed to new participants. The Police and Firefighters’ Pre-1977 Plans are reported as pension trust funds in the City’s financial statements.

Management of the Police and Firefighters’ Pre-1977 Plans is vested in separate boards of trustees (“Local Boards”), the responsibilities of which include the determination of eligibility for benefits, rates of contribution, and amount of benefits to be paid to plan participants or their beneficiaries. The Local Board for the Police Pre-1977 Plan is comprised of the Mayor, the Marion County Treasurer, the City Police Chief, one retired member of the police department (elected from among all the retired members), and five active members (elected from among all active members) of the police department. The Local Board for the Firefighters’ Pre-1977 Plan is comprised of the Mayor and the City Fire Chief, who are ex-officio voting trustees, one retired member (elected from among all the retired members) of the fire department, and four active members (elected from among all active members) of the fire department.

*Employees Covered by Benefit Terms*

Employees covered by benefit terms of the Police and Firefighters’ Pre-1977 Plans as of December 31, 2022 follows:

	<b>Pre-1977 Police Plan</b>	<b>Pre-1977 Firefighters' Plan</b>
Retirees and beneficiaries currently receiving benefits	665	636
Current employees - vested	4	1
Total	669	637

*Funding Policy*

In 1977, the Pension Relief Fund (IC 5-10.3-11) was created by the Indiana General Assembly to provide financial relief to pension funds maintained by units of local government in Indiana for their police officers’ and firefighters’ retirement plan benefits. The Indiana Public Retirement System (“INPRS”) is responsible for managing the Pension Relief Fund and making disbursements to the local police and firefighter units throughout the state from funds provided by the Indiana General Assembly. Funding for the Pension Relief Fund is derived from a portion of state cigarette and alcohol taxes, a portion of the state’s lottery proceeds, interest earned by the Indiana Public Deposit Insurance Fund, investment income, and appropriations from the Indiana General Assembly. Separate accounts are maintained by INPRS for each unit of local government for amounts that have yet to be distributed. Such amounts remain invested in the fund and are available to the units of local government upon request.

*Retirement Benefits*

Retirement benefits are available after 20 years of service. Contractually, as current employees’ salaries increase, benefits paid to plan participants are adjusted. An employee who retires from active duty after 20 or more years is entitled to an annual pension equal to 50% of the salary of a first-class officer/firefighter, as defined by the City. An employee who serves more than 20 years is entitled to additional amounts equal to: (1) 2% per year for each year of service over 20 years, for an employee who retired before January 1, 1986; or (2) 1% for each half year of service over 20 years, for an employee who retires after December 31, 1985. The maximum benefit is equal to 74% of the salary of a first-class officer/firefighter. Monthly pension benefits may be adjusted annually by a cost of living adjustment (“COLA”) based upon increases in the Consumer Price Index up to a maximum of 3%.

**CITY OF INDIANAPOLIS**  
**(A Component Unit of the Consolidated City of Indianapolis – Marion County)**  
Notes to Financial Statements  
December 31, 2022  
(Dollars in Thousands)

---

***Disability and Survivor Benefits***

Generally, an employee who becomes permanently disabled is entitled to receive a monthly disability benefit equal to 55% of the salary of a first-class officer/firefighter. An employee receiving disability benefits is entitled to: (1) receive disability benefits for the remainder of the employee’s life; and (2) have the benefit recomputed as a regular retirement benefit when the employee reaches age 55. The time spent receiving disability benefits is counted as active service for the purpose of determining retirement benefits until the employee reaches a total of 20 years of service. If an employee receiving disability benefits elects to have the benefit computed as a regular retirement benefit, the employee’s monthly pension may not be reduced below 55% of the salary of a first-class officer/firefighter at the time of the payment of the pension. An employee who is temporarily disabled is entitled to receive a monthly disability benefit equal to 30% of the salary of a first-class officer/firefighter until the employee is able to return to active service.

The surviving spouse and children of a deceased employee covered under the Police and Firefighters’ Pre-1977 Plans receive certain financial assistance, among which include monthly survivor benefits, special death benefits, and health insurance.

***Contributions Required and Contributions Made***

Beginning in 2009, the State began paying the entire annual cost of pension benefits for the police officers and firefighters who are participants of the Pre-1977 plans, including those of the City. Since the City still must pay the benefits under the plans and be reimbursed by the State, these are still considered to be “pay-as-you-go” plans. The payments from the State are estimated each year and any overage or underage is to be adjusted in the next year. In 2022, the State of Indiana contributed \$55,269 of pension relief to the City’s Police and Firefighters’ Pre-1977 Plans (\$27,771 and \$27,498, respectively), which has been reported as contribution revenue by the City.

There are no remaining employee contribution requirements. No significant plan assets are accumulated for the payment of future benefits.

**2. 1977 Police Officers’ and Firefighters’ Pension and Disability Fund**

***Plan Description***

The 1977 Police Officers’ and Firefighters’ Pension and Disability Fund (“1977 Police and Firefighters’ Plan”) is a cost-sharing multiple-employer retirement defined benefit plan established in accordance with IC 36-8-8 to provide retirement, disability, and survivor benefits to all of the City’s full-time police officers and firefighters who were hired after April 30, 1977, or who were hired before May 1, 1977, and have elected to convert to this plan. The plan is administered by INPRS and is governed by the INPRS Board of Trustees (“INPRS Board”). Benefits are established by statute and may only be amended by the Indiana General Assembly. INPRS issues a publicly available financial report that includes financial statements and required supplementary information for the 1977 Police and Firefighters’ Plan, which may be obtained by contacting INPRS at 1 North Capitol, Suite 001, Indianapolis, Indiana 46204, or by calling 888-526-1687.

***Funding Policy***

The INPRS Board has established a funding policy that requires that employer contributions be equal to the sum of the employer normal cost (which pays the current year cost of benefits accruing) and an amortization of the unfunded actuarial accrued liability. Presently, covered employees are annually required to contribute 6% of their compensation over the term of their employment up to 32 years. The City currently pays half of the employee contribution in accordance with its associated labor agreements. This is in addition to the annual employer’s contribution determined by INPRS based on a valuation using the entry age normal cost method. The rate of employer contribution is 17.5% of each employee’s annual compensation.

Effective January 1, 2007, the sheriff deputies from Marion County were merged with the former Indianapolis Police Department to form the Indianapolis Metropolitan Police Department, which is part of the City. The pension plan for the former sheriff deputies who are now part of the Indianapolis Metropolitan Police Department is funded by the County, and accordingly, the liability is held by the County in the Marion County Law Enforcement Fund.

**CITY OF INDIANAPOLIS**  
**(A Component Unit of the Consolidated City of Indianapolis – Marion County)**  
Notes to Financial Statements  
December 31, 2022  
(Dollars in Thousands)

---

***Retirement Benefits***

Benefits vest after 20 years of service. For those employees who retire at or after the age of 52 with 20 years of service, the benefit is equal to 50% of compensation for the last year of service, plus 1% of such compensation for each six months of active service over 20 years to a maximum of 12 years. At age 50 and with 20 years of service, a retiree may elect to receive a reduced benefit by a factor established by the plan's actuary. Monthly pension benefits may be adjusted annually by a cost-of-living adjustment ("COLA") based upon increases in the Consumer Price Index up to a maximum of 3%.

***Disability and Survivor Benefits***

A covered employee may file an application for disability benefits. A determination is then made by the Local Board, and reviewed by the INPRS Board, as to whether the employee has a covered impairment and whether or not the impairment was sustained in the line of duty. The amount of disability benefits is based upon when the employee was hired, the type of impairment and certain other factors, but may not exceed 55% of the monthly salary (with longevity pay) of a first-class officer/firefighter.

If a covered employee dies while receiving retirement or disability benefits, there are provisions for the surviving spouse and children to receive a portion of the benefits, among which include monthly survivor benefits, special death benefits, and health insurance.

***Contributions Required and Contributions Made***

Employer contribution rates are adopted annually by the INPRS Board for the 1977 Police and Firefighters' Plan. The contributions are actuarially determined based on the funding policy, actuarial assumptions, and actuarial methods established by the INPRS Board. Contributions determined by the actuarial valuation become effective either 12 or 18 months after the valuation date, depending on the applicable employer. In the case of the City, contribution rates and amounts determined by the June 30, 2020 actuarial valuation and adopted by the INPRS Board therefore become effective on January 1, 2022. The City's contractually required contribution rate for 2022 was 17.5% of annual payroll, actuarially determined as an amount that is expected to finance the costs of benefits earned by employees during the year, with an additional amount to finance any unfunded accrued liability. The City's contributions to the plan for the year ended December 31, 2022, exclusive of employer-paid member contributions, was \$38,882, equal to the approved employer contribution and 17.5% of covered payroll for each year.

**3. Deferred Retirement Option Plan**

***Plan Description***

Indiana's Deferred Retirement Option Plan ("DROP"), which was enacted into law in 2002, is available to all participants of the Police and Firefighters' Pre-1977 Plans and the 1977 Police and Firefighters' Plan. Those employees who elect to participate must remain in active employment, continue to make contributions to the plan and elect a DROP retirement date not less than 12 months and not more than 36 months after the member's DROP entry date. Participating employees remain in the DROP until reaching the applicable mandatory retirement age and may make a DROP election only once in the employee's lifetime. Upon retirement, a DROP participant will receive a DROP frozen benefit to be paid in a lump-sum distribution or in 3 equal installments commencing on the participant's DROP retirement date. The City does not set aside amounts for the DROP participants under the Police and Firefighters' Pre-1977 Plans. As of June 30, 2022, a total of \$110,500 is held under the DROP for participating government employers of the 1977 Police and Firefighters' Plan.

**4. Indiana Public Employees' Retirement Fund**

***Plan Description***

The City also contributes to the Indiana Public Employees' Retirement Fund ("PERF"), a cost-sharing multiple-employer defined benefit pension plan established in accordance with IC 5-10.3 to act as a common investment and administrative agent for units of state and local governments in Indiana. PERF is administered by INPRS and is governed by the INPRS Board. PERF provides retirement, disability, and survivor benefits to full-time employees of the State of Indiana not covered by another plan, those political subdivisions that elect to participate in the retirement plan and certain INPRS employees. Except for police and firefighters, all full-time City employees are eligible to participate in this plan. Additionally, all full-time employees of the Housing Agency participate in PERF under the City's employer account. INPRS issues a publicly available financial report that includes financial statements and required supplementary information for PERF and can be found at <http://www.inprs.in.gov/>. This report may also be obtained by writing to Indiana Public Retirement System, 1 North Capitol, Suite 001, Indianapolis, Indiana 46204, or by calling 888-526-1687. Pension disclosures for the Housing Agency are not included in this report but can be found in the Housing Agency's separately issued financial report.

**CITY OF INDIANAPOLIS**  
**(A Component Unit of the Consolidated City of Indianapolis – Marion County)**  
Notes to Financial Statements  
December 31, 2022  
(Dollars in Thousands)

---

There are two tiers to the PERF plan. The first is the Public Employee’s Defined Benefit Plan (“PERF Hybrid Plan”) and the second is the My Choice: Retirement Savings Plan for Public Employees (“My Choice Plan”). Effective January 1, 2017 through December 31, 2021, new employees hired by the City were enrolled in the My Choice Plan, with the exception of the American Federation of State, County, and Municipal Employees (“AFSCME”) union employees, which had the option of enrolling in either the PERF Hybrid or My Choice Plan. During 2021, the City-County Council adopted a resolution, which modified the retirement options offered by INPRS for new employees, effective January 1, 2022. Employees with an employment start date on or after, January 1, 2022, have a choice between membership in either the PERF Hybrid Plan or the My Choice Plan. Members have 60 days to make an election. If no election is made within 60 days, they will automatically default into the PERF Hybrid Plan.

There are two aspects to the PERF Hybrid Plan defined benefit structure. The first portion is the monthly defined benefit pension that is funded by the employer. The second portion of the PERF Hybrid Plan benefit structure is the Public Employees’ Hybrid Members Defined Contribution Account that supplements the defined benefit at retirement.

Effective January 1, 2018, funds previously known as annuity savings accounts (which were reported within defined benefit funds) were re-categorized as defined contribution funds based on Internal Revenue Private Letter Rulings PLR-193-2016 and PLR-110249-18. PERF Defined Contribution member balances (previously known as annuity savings accounts) reported within PERF DB were transferred to the appropriate defined contribution fund as of January 1, 2018.

***Funding Policy***

The funding policy of INPRS provides for actuarially determined periodic contributions at rates that, for individual employees, increase gradually over time so that sufficient assets will be available to pay benefits when due.

PERF Hybrid Plan

The employer defined benefit contribution rate is based on an actuarial valuation and is adopted, and may be amended, by the INPRS Board. For 2022, the City contributed 11.2% of employee compensation to the plan. The Defined Contribution Account consists of the employee contribution, which is set by statute at 3% of compensation, as defined by Indiana statutes, plus the interest/earnings or losses credited to the employee’s account. The employer may choose to make the contributions on behalf of its participating employees, which the City has elected to do. In addition, under certain circumstances, employees may elect to make additional voluntary contributions of up to 10% of their compensation into their Defined Contribution Account. An employee’s contribution and interest credits belong to the employee and do not belong to the state or the City.

My Choice Plan

For the My Choice Plan, member contributions are set by statute at 3% of compensation, plus these members may receive additional employer contributions in lieu of the Public Employees’ Defined Benefit Account. The City has elected to make the 3% required contribution on behalf of the employed members and has elected to contribute an additional 1.2% for 2022. In addition, for the My Choice Plan, all participating employers were required to make a 7.0% supplemental contribution toward the fund’s actuarial unfunded liability.

***Retirement Benefits – PERF Hybrid Plan***

Defined Benefit Account

The PERF Hybrid Plan retirement benefit consists of the sum of a defined pension benefit provided by employer contributions plus the amount credited to the employee’s Defined Contribution Account. Retirement benefits vest after ten years of creditable service. The vesting period is eight years for certain elected officials. Employees are immediately vested in their respective annuity savings accounts. At retirement, an employee may choose to receive a lump-sum payment of the amount credited to the employee’s Defined Contribution Account, receive the amount as an annuity or leave the contributions invested with INPRS.

Vested employees leaving a covered position, who wait 30 days after termination, may withdraw their Defined Contribution Account and will not forfeit creditable service or a full retirement benefit. However, if an employee is eligible for a full retirement at the time of the withdrawal request, he/she will have to begin drawing his/her pension benefit in order to withdraw the Defined Contribution Account. A nonvested employee who terminates employment prior to retirement may withdraw his/ her Defined Contribution Account after 30 days, but by doing so, forfeits his/her creditable service. An employee who returns to covered service and works no less than six (6) months in a covered position may reclaim his/her forfeited creditable service.

An employee who has reached: (1) age 65 and has at least 10 years of creditable service; (2) age 60 and has at least 15 years of creditable service; or (3) at least age 55 and whose age plus number of years of creditable service is at least 85 is eligible for normal retirement and, as such, is entitled to 100% of the pension benefit component. This annual pension benefit is

**CITY OF INDIANAPOLIS**  
**(A Component Unit of the Consolidated City of Indianapolis – Marion County)**  
Notes to Financial Statements  
December 31, 2022  
(Dollars in Thousands)

---

equal to 1.10% times the average annual compensation times the number of years of creditable service. The average annual compensation in this calculation uses the 20 calendar quarters of creditable service in which the employee's annual compensation was the highest. All 20 calendar quarters do not have to be continuous, but they must be in groups of four consecutive calendar quarters. The same calendar quarter may not be included in two different groups. Employee contributions paid by the employer on behalf of the employee and severance pay up to \$2 are included as part of the employee's salary.

An employee who has reached at least age 50 and has at least 15 years of creditable service is eligible for early retirement with a reduced pension. An employee retiring early receives a percentage of the normal annual pension benefit. The percentage of the pension benefit at retirement remains the same for the employee's lifetime. For age 59, the early retirement percentage of the normal annual pension benefit is 89%. This amount is reduced five percentage points per year (e.g., age 58 is 84%) to age 50 being 44%.

The monthly pension benefits for employees in pay status may be increased periodically by COLAs. Such increases are not guaranteed by statute and have historically been provided on an "ad hoc" basis and can only be granted by the Indiana General Assembly.

Defined Contribution Account

The Public Employees' Hybrid Members Defined Contribution Account (PERF Hybrid DC) is the defined-contribution component of the Public Employees' Hybrid Plan. The Public Employees' Defined Benefit Account is the other component of the Public Employees' Hybrid Plan. Member contributions are set by statute at 3% of compensation, and the employer may choose to make these contributions on behalf of the member, which the City has done. Members are 100% vested in their account balance, which includes all contributions and earnings. The City has elected to make this contribution on behalf of the employed members. The contribution for the year ended December 31, 2022 was \$1,677.

***Disability and Survivor Benefits***

The PERF Hybrid Plan also provides disability and survivor benefits. An employee who has at least five years of creditable service and becomes disabled while in active service, on FMLA leave, receiving workers' compensation benefits, or receiving employer-provided disability insurance benefits may retire for the duration of the disability, if the employee has qualified for social security disability benefits and has furnished proof of the qualification. The disability benefit is calculated the same as that for a normal retirement without reduction for early retirement. The minimum benefit is \$180 per month (not in thousands), or the actuarial equivalent.

Upon the death of an employee in service with 15 or more years of creditable service as of January 1, 2007, a survivor benefit may be paid to the surviving spouse to whom the employee had been married for two or more years or to surviving dependent children under the age of 18. This payment is equal to the benefit which would have been payable to a beneficiary if the employee had retired at age 50 or at death, whichever is later, under an effective election of the joint and survivor option available for retirement benefits. A surviving spouse or surviving dependent children are also entitled to a survivor benefit upon the death of an employee in service after January 1, 2007, who was at least 65 years of age and had at least 10 but not more than 14 years of creditable service.

The authority to establish or amend benefit provisions of PERF rests with the Indiana General Assembly.

***Contributions Required and Contributions Made***

Employer contribution rates are adopted annually by the INPRS Board for PERF. The contributions are actuarially determined based on the funding policy, actuarial assumptions and actuarial methods established by the INPRS Board. Contributions determined by the actuarial valuation become effective either 12 or 18 months after the valuation date, depending on the applicable employer. In the case of the City, contribution rates and amounts determined by the June 30, 2020 actuarial valuation and adopted by the INPRS Board therefore become effective on January 1, 2022. The City's contractually required contribution rate for 2022 was 11.2% of annual payroll, actuarially determined as an amount that is expected to finance the costs of benefits earned by employees during the year, with an additional amount to finance any unfunded accrued liability. The City's contribution to the plan for the year ended December 31, 2022, exclusive of employer-paid member contributions, was \$6,240, equal to the approved employer contribution and 11.2% of covered payroll for each year.



**CITY OF INDIANAPOLIS**  
**(A Component Unit of the Consolidated City of Indianapolis – Marion County)**  
Notes to Financial Statements  
December 31, 2022  
(Dollars in Thousands)

---

***Retirement Benefits – My Choice Plan***

Defined Contribution Account

The My Choice Plan is a multi-employer defined-contribution fund that serves as the primary retirement benefit for the My Choice: Retirement Savings Plan for Public Employees (My Choice) members.

Member contributions are set by statute at 3% of compensation, plus these members may receive additional employer contributions in lieu of the Public Employees’ Defined Benefit Account. The City has elected to make the 3% required contribution on behalf of the employed members, which was \$745 for 2022. Employers can also choose to make an additional contribution to employee accounts ranging from 0% up to the normal cost of the fund. The normal cost for 2022 was 3.2%. The City elected to contribute an additional 1.2% for 2022, which was \$226 for 2022. In addition, for the My Choice Plan, all participating employers are required to make a 8.0% supplemental contribution toward the fund’s actuarial unfunded liability, which was \$1,810 in 2022.

Members are 100% vested in all member contributions, which is the 3% required contribution the City has elected to contribute, and are vested as follows in the additional employer contributions which includes all earnings:

Years of Service				
1	2	3	4	5+
20%	40%	60%	80%	100%

Investments are self-directed; members may make changes daily, and investments are reported at fair value. Market risk is assumed by the member, and the member may choose among the following eight investment options with varying degrees of risk and return potential: Stable Value Fund, Large Cap Equity Index Fund, Small/Mid Cap Equity Fund, International Equity Fund, Fixed Income Fund, Inflation-Linked Fixed Income Fund, Target Date Funds, and Money Market Fund.

INPRS issues a publicly available financial report that includes financial statements and required supplementary information. That report may be obtained at <http://www.inprs.in.gov/>.

**CITY OF INDIANAPOLIS**  
**(A Component Unit of the Consolidated City of Indianapolis – Marion County)**  
Notes to Financial Statements  
December 31, 2022  
(Dollars in Thousands)

**B. Assumptions**

The significant actuarial methods and assumptions used in relation to the actuarial valuations for each of the City's pension plans are summarized below:

<u>Assumptions</u>	<u>Police Pre-1977 Plan</u>	<u>Firefighters' Pre-1977 Plan</u>	<u>1977 Police and Firefighters' Plan</u>	<u>PERF</u>
Date of valuation	January 1, 2022	January 1, 2022	Assets: June 30, 2022 Liabilities: June 30, 2021 - rolled forward to measurement date	Assets: June 30, 2022 Liabilities: June 30, 2021 - rolled forward to measurement date
Measurement date	December 31, 2022	December 31, 2022	June 30, 2022	June 30, 2022
Actuarial cost method	Entry Age Normal - Level Percent of Payroll	Entry Age Normal - Level Percent of Payroll	Entry Age Normal - Level Percent of Payroll	Entry Age Normal - Level Percent of Payroll
Long-term expected return on plan assets	N/A	N/A	6.25%	6.25%
Money-weighted rate of return	N/A	N/A	-6.60%	-6.60%
Inflation rate	2.00%	2.00%	2.00%	2.00%
Cost of living adjustment	Non-converted - 2.65% each July 1 Converted - 3.00% on July 1, 2022; 1.95% thereafter	Non-converted - 2.65% each July 1 Converted - 3.00% on July 1, 2022; 1.95% thereafter	1.95%	1.00%
Salary increase	2.65%	2.65%	2.65%	2.65% - 8.65%
Mortality	Pub-2010 Public Retirement Plans Mortality Tables with a fully generational projection of mortality improvements using SOA Scale MP-2019	Pub-2010 Public Retirement Plans Mortality Tables with a fully generational projection of mortality improvements using SOA Scale MP-2019	Pub-2010 Public Retirement Plans Mortality Tables with a fully generational projection of mortality improvements using SOA Scale MP-2019	Pub-2010 Public Retirement Plans Mortality Tables with a fully generational projection of mortality improvements using SOA Scale MP-2019
Experience period	7/1/2015 to 6/30/2019	7/1/2015 to 6/30/2019	6/30/2014 to 6/30/2019	6/30/2014 to 6/30/2019
Discount rate	Barclay's 20-year Municipal Bond Index:	Barclay's 20-year Municipal Bond Index:		
2022	4.12%	4.12%	6.25%	6.25%
2021	1.39%	1.39%	6.25%	6.25%
Asset valuation method	N/A - pay-as-you-go-basis	N/A - pay-as-you-go-basis	5-year smoothing of gains/losses on market value with a 20% corridor	5-year smoothing of gains/losses on market value with a 20% corridor
Amortization method	N/A	N/A	Level dollar	Level dollar
Amortization period	N/A	N/A	Closed – 20 years	Closed – 20 years

**CITY OF INDIANAPOLIS**  
**(A Component Unit of the Consolidated City of Indianapolis – Marion County)**  
Notes to Financial Statements  
December 31, 2022  
(Dollars in Thousands)

---

The long-term expected rate of return on pension plan investments for the 1977 Police and Firefighters’ Plan and PERF were determined using a building-block approach and assume a time horizon, as defined in the INPRS Investment Policy Statement. A forecasted rate of inflation serves as the baseline for the return expectation. Various real return premiums over the baseline inflation rate have been established for each asset class. The long-term expected nominal rate of return has been determined by calculating a weighted-average of the expected real return premiums for each asset class, adding the projected inflation rate and adding the expected return from rebalancing uncorrelated asset classes. The target allocation and best estimates of geometric real rates of return for each major asset class are summarized in the following table for the 1977 Police and Firefighters’ Plan and PERF:

<b>Asset Class</b>	<b>Target Allocation</b>	<b>Long-Term Expected Real Rate of Return</b>
Public equity	20%	3.6%
Private equity	15%	7.7%
Fixed income - ex inflation-linked	20%	1.4%
Fixed income - inflation-linked	15%	-0.3%
Commodities	10%	0.9%
Real estate	10%	3.7%
Absolute return	5%	2.1%
Risk parity	20%	3.8%
Cash and cash overlay	-15%	-1.7%
Total	100%	

***Discount Rates***

Because the Police and Firefighters’ Pre-1977 Plans have no accumulated assets, the discount rates for these plans are equal to the Barclay’s 20-year Municipal Bond Index for the year ended December 31, 2022.

The discount rate used to measure the total pension liability for the 1977 Police and Firefighters’ Plan and PERF was 6.25%. The projection of cash flows used to determine the discount rate assumed that employee contributions will be made at the current contribution rate and that participating employer contributions will be made at contractually required rates, actuarially determined. Based on those assumptions, the fiduciary net position for each of these plans was projected to be available to make all projected future benefit payments of current active and inactive employees. Therefore, the long-term expected rate of return on pension plan investments was applied to all periods of projected benefit payments to determine the respective total pension liability.

**CITY OF INDIANAPOLIS**  
**(A Component Unit of the Consolidated City of Indianapolis – Marion County)**  
Notes to Financial Statements  
December 31, 2022  
(Dollars in Thousands)

***Sensitivity of the Net Pension Liability (Asset) to Changes in the Discount Rate***

The following represents the City’s net pension liabilities (assets), by plan and in the aggregate, calculated using discount rates 1% higher and 1% lower than their respective current discount rates:

<u>Plan</u>	<u>Net Pension Liability (Asset)</u>		
	<u>1% Decrease</u>	<u>Current Rate</u>	<u>1% Increase</u>
Pre-1977 Police Plan (current rate: 4.12%)	\$ 314,372	\$ 290,179	\$ 269,115
Pre-1977 Firefighters' Plan (current rate: 4.12%)	296,495	274,116	254,616
1977 Police and Firefighters' Plan (current rate: 6.25%) - proportionate share (22.23%)	431,780	144,013	(88,260)
PERF (current rate: 6.25%) - proportionate share (1.31%)	69,973	41,420	17,604
Total	<u>\$ 1,112,620</u>	<u>\$ 749,728</u>	<u>\$ 453,075</u>

**C. Pension Liabilities (Assets), Pension Expense, Deferred Outflows of Resources and Deferred Inflows of Resources Related to Pensions**

The net pension liabilities for the Police and Firefighters’ Pre-1977 Plans were measured as of December 31, 2022 and the total pension liability used to calculate the net liability was determined by an actuarial valuation as of January 1, 2022 rolled forward to the measurement date. Member census data as of December 31, 2021, was used in the valuation and adjusted, where appropriate, to reflect changes between December 31, 2021 and December 31, 2022. For December 31, 2022 valuations, there were numerous assumption changes. See below:

1. Discount Rate: The discount rate used for the December 31, 2022 valuation was 4.12%, as directed by INPRS, based on the Barclay's 20-year Municipal Bond Index as of December 31, 2022. This is an increase from the 1.39% used for the December 31, 2021 valuation.
2. Cost-of-living-adjustment (COLA): For converted members, the July 1, 2022 COLA of 3.00% was used in place of the ongoing valuation assumption to reflect the known increase. Beginning July 1, 2023, the assumption reverts to the assumed annual rate of 1.95%. For non-converted members, there was no change and the COLA remains at 2.65%.

The net pension liability for the 1977 Police and Firefighters’ Plan was measured as of June 30, 2022 and the total pension liability used to calculate the net pension liability was determined by an actuarial valuation as of June 30, 2021 rolled forward to the measurement date. Member census data as of June 30, 2021, was used in the valuation and adjusted, where appropriate, to reflect changes between June 30, 2021 and June 30, 2022. Standard actuarial roll forward techniques were then used to project the total pension liability computed as of June 30, 2021 to the June 30, 2022 measurement date. Wages reported by the City for police officers and for firefighters relative to the collective wages of the plan served as the basis to determine the City’s proportionate share for each member population. This basis of allocation is consistent with the manner in which contributions to the pension plan are determined. At June 30, 2022, the City’s proportion for its police officers was 11.86371%, which was a decrease of 0.02336% from its proportion measured as of June 30, 2021. At June 30, 2022, the City’s proportion for its firefighters was 10.36554%, which was an increase of 0.59417% from its proportion measured as of June 30, 2021.

The net pension liability for PERF was measured as of June 30, 2022 and the total pension liability used to calculate the net pension liability was determined by an actuarial valuation as of June 30, 2021 rolled forward to the measurement date. Member census data as of June 30, 2021, was used in the valuation and adjusted, where appropriate, to reflect changes between June 30, 2021 and June 30, 2022. Standard actuarial roll forward techniques were then used to project the total pension liability computed as of June 30, 2021 to the June 30, 2022 measurement date. Wages reported by the City relative to the collective wages of the plan served as the basis to determine the City’s proportionate share. This basis of allocation is consistent with the manner in which contributions to the pension plan are determined. At June 30, 2022, the City’s proportion was 1.31332%, which was a decrease of 0.1122% from its proportion measured as of June 30, 2021.

**CITY OF INDIANAPOLIS**  
**(A Component Unit of the Consolidated City of Indianapolis – Marion County)**  
Notes to Financial Statements  
December 31, 2022  
(Dollars in Thousands)

At December 31, 2022, the City reported the following net pension liabilities, pension expense, deferred outflows of resources, and deferred inflows of resources related to the City’s four pension plans in which it participates:

<u>Plan</u>	<u>Net Pension Liability</u>	<u>Deferred Outflows of Resources</u>	<u>Deferred Inflows of Resources</u>	<u>Pension Expense</u>
Pre-1977 Police Plan	\$ 290,179	\$ —	\$ —	\$ (61,790)
Pre-1977 Firefighters' Plan	274,116	—	—	(51,290)
1977 Police and Firefighters' Plan	144,013	202,532	14,907	38,004
PERF	41,420	15,908	6,074	4,221
Total	<u>\$ 749,728</u>	<u>\$ 218,440</u>	<u>\$ 20,981</u>	<u>\$ (70,855)</u>

The components of the net pension liability of the City for the Police and Firefighters’ Pre-1977 Plans as of December 31, 2022 were as follows:

	<u>Pre-1977 Police Plan</u>	<u>Pre-1977 Firefighters' Plan</u>
Total pension liability	291,061	274,803
Plan's fiduciary net position	882	687
City's net pension liability	<u>290,179</u>	<u>274,116</u>
Plan fiduciary net position as a percentage of the total pension liability	<u>0.30%</u>	<u>0.25%</u>

**CITY OF INDIANAPOLIS**  
**(A Component Unit of the Consolidated City of Indianapolis – Marion County)**  
Notes to Financial Statements  
December 31, 2022  
(Dollars in Thousands)

The changes in the net pension liability for the Police and Firefighters' Pre-1977 Plans follow:

	<u>Pre-1977 Police Plan</u>			<u>Pre-1977 Firefighters' Plan</u>		
	<u>Total Pension Liability</u>	<u>Fiduciary Net Position</u>	<u>Net Pension Liability</u>	<u>Total Pension Liability</u>	<u>Fiduciary Net Position</u>	<u>Net Pension Liability</u>
Balances as of January 1, 2022	\$ 379,854	\$ (357)	\$ 380,211	\$ 352,667	\$ (609)	\$ 353,276
Changes for the year:						
Service cost	—	—	—	67	—	67
Interest on total pension liability	5,210	—	5,210	4,906	—	4,906
Difference between expected and actual experience	8,429	—	8,429	13,489	—	13,489
Effect of assumptions changes	(75,441)	—	(75,441)	(69,767)	—	(69,767)
Nonemployer contributing entity contributions	—	27,771	(27,771)	—	27,498	(27,498)
Projected benefit payments	(26,991)	—	(26,991)	(26,559)	—	(26,559)
Benefit payments	—	(26,532)	26,532	—	(26,202)	26,202
Total net changes	<u>(88,793)</u>	<u>1,239</u>	<u>(90,032)</u>	<u>(77,864)</u>	<u>1,296</u>	<u>(79,160)</u>
Balances as of December 31, 2022	<u>\$ 291,061</u>	<u>\$ 882</u>	<u>\$ 290,179</u>	<u>\$ 274,803</u>	<u>\$ 687</u>	<u>\$ 274,116</u>

Detailed information regarding the fiduciary net position for the 1977 Police and Firefighters' Plan and PERF is available in the separately issued financial reports for these plans.

The Police and Firefighters' Pre-1977 Plans have no deferred outflows of resources or deferred inflows of resources as of December 31, 2022. Deferred outflows of resources and deferred inflows of resources related to the 1977 Police and Firefighters' Plan and PERF as of December 31, 2022 are from the following sources:

	<u>1977 Police and Firefighters' Plan</u>		<u>PERF</u>		<u>Total</u>	
	<u>Deferred Outflows of Resources</u>	<u>Deferred Inflows of Resources</u>	<u>Deferred Outflows of Resources</u>	<u>Deferred Inflows of Resources</u>	<u>Deferred Outflows of Resources</u>	<u>Deferred Inflows of Resources</u>
Differences between expected and actual experience	\$ 73,653	\$ 2,010	\$ 893	\$ 158	\$ 74,546	\$ 2,168
Net difference between projected and actual earnings on pension plan investments	45,836	—	5,112	—	50,948	—
Changes in assumptions	61,450	11,357	5,610	1,772	67,060	13,129
Changes in proportion and differences between the City's contribution and proportionate share contributions	881	1,540	608	4,144	1,489	5,684
City's contributions subsequent to the measurement date	20,712	—	3,685	—	24,397	—
Total	<u>\$ 202,532</u>	<u>\$ 14,907</u>	<u>\$ 15,908</u>	<u>\$ 6,074</u>	<u>\$ 218,440</u>	<u>\$ 20,981</u>

**CITY OF INDIANAPOLIS**  
**(A Component Unit of the Consolidated City of Indianapolis – Marion County)**  
Notes to Financial Statements  
December 31, 2022  
(Dollars in Thousands)

At December 31, 2022, the City reported \$20,712 and \$3,685 as deferred outflows of resources related to pensions resulting from plan contributions made by the City to the 1977 Police and Firefighters' Plan and PERF, respectively, subsequent to the measurement date. Therefore, \$20,712 will be recognized as a decrease in the net pension liability for the 1977 Police and Firefighters' Plan and \$3,685 will be recognized as a decrease in the net pension liability for PERF in the year ended December 31, 2023. Other amounts reported as deferred outflows of resources and deferred inflows of resources at December 31, 2022, related to pensions will be recognized in pension expense as follows:

	<b>1977 Police and Firefighters'</b>		
	<b>Plan</b>	<b>PERF</b>	<b>Total</b>
2023	\$ 17,029	\$ 550	\$ 17,579
2024	24,768	1,745	26,513
2025	14,609	(1,552)	13,057
2026	67,876	5,406	73,282
2027	18,612	—	18,612
Thereafter	24,019	—	24,019
<b>Total</b>	<b>\$ 166,913</b>	<b>\$ 6,149</b>	<b>\$ 173,062</b>

**D. Pension Trust Fund Financial Statements**

Separately issued financial statements are not available for the Police and Firefighters' Pre-1977 Plans. The combining statement of pension trust funds net position at December 31, 2022 follows:

	<b>Police Pension</b>	<b>Firefighters' Pension</b>	<b>Total</b>
<b>ASSETS</b>			
Equity in pooled cash	\$ 65	\$ 49	\$ 114
City's pooled investments	817	638	1,455
Total assets	882	687	1,569
<b>NET POSITION</b>			
Net position restricted for pensions	\$ 882	\$ 687	\$ 1,569

**CITY OF INDIANAPOLIS**  
**(A Component Unit of the Consolidated City of Indianapolis – Marion County)**  
Notes to Financial Statements  
December 31, 2022  
(Dollars in Thousands)

The combining statement of changes in fiduciary net position for the year ended December 31, 2022 follows:

	<b>Police Pension</b>	<b>Firefighters' Pension</b>	<b>Total</b>
<b>ADDITIONS</b>			
Employer contributions	\$ 27,771	\$ 27,498	\$ 55,269
<b>DEDUCTIONS</b>			
Benefits	26,532	26,202	52,734
Net increase (decrease) in net position	1,239	1,296	2,535
Net position restricted for pensions – beginning of year	(357)	(609)	(966)
Net position restricted for pensions – end of year	\$ 882	\$ 687	\$ 1,569

**E. Discretely Presented Component Unit**

The pension schedule and required supplementary information for the City’s discretely presented component unit, the Housing Agency, is immaterial to the City’s financial statements, and therefore is not included in this report. The detailed disclosures can be found in the separately issued financial statements of the Housing Agency.

**16. Deferred Compensation Plan**

Employees of the City of Indianapolis are eligible to participate in a deferred compensation plan adopted under the provisions of Internal Revenue Code (“IRC”) Section 457. The deferred compensation plan is available to all employees of the City. Under this plan, employees may elect to defer a portion of their salaries and avoid paying taxes on the deferred portion until the withdrawal date. The deferred compensation amount is not available for withdrawal by employees until termination, retirement, death, or unforeseeable emergency. Plan assets are held in trust by an independent trustee for the exclusive benefit of participants and their beneficiaries and are not included within the accompanying financial statements. Effective July 1, 2022, the City elected to provide an employer match to all civilian employees. The match is a one-for-one match, not to exceed \$50 per pay/\$1,200 a year (not in thousands).

**17. Contingent Liabilities and Commitments**

- A.** Various lawsuits are pending against the City. In the opinion of the City’s Corporation Counsel, the aggregate potential loss on all outstanding litigation for public liability self-insurance was estimated to be \$2,707 at December 31, 2022. This amount has been accrued for in the Internal Service Fund. Indiana law limits the liability of municipalities to \$700 per person and \$5,000 per occurrence. Additionally, the City is a defendant in various lawsuits for which management has determined that there is a reasonable possibility of an adverse outcome. No accrual has been made in the financial statements for these items, which approximate \$2,860 – \$26,245, as these potential losses are not both probable and estimable.
- B.** The City has received federal and state grants for specific purposes that are subject to review and audit by the grantor agencies. Such audits could lead to requests for reimbursement by the grantor agency for expenditures disallowed under the terms of the grants.

**18. Risk Management**

The City is insured for property and certain liability losses, subject to certain deductible amounts, except that it is self-insured for auto liability, a high deductible health insurance plan, general liability (excluding certain other catastrophes), workers’ compensation inpatient services, and services delivered at a site other than that provided for in the workers’ compensation agreement. Expenses are recorded when a determinable loss is probable, and the amount of the loss can be estimated.



**CITY OF INDIANAPOLIS**  
**(A Component Unit of the Consolidated City of Indianapolis – Marion County)**  
Notes to Financial Statements  
December 31, 2022  
(Dollars in Thousands)

The change in claims for 2022 and 2021, including an estimate of incurred but not reported claims, is as follows:

	<u>Risk Management</u>	<u>Public Liability Self-Insurance</u>	<u>Employee Health Insurance</u>	<u>Total</u>
Unpaid claims, December 31, 2020	\$ 9,433	\$ 876	\$ 15,748	\$ 26,057
Incurred claims and changes in estimates	7,414	4,052	98,437	109,903
Claims paid	<u>(7,603)</u>	<u>(3,529)</u>	<u>(102,344)</u>	<u>(113,476)</u>
Unpaid claims, December 31, 2021	\$ 9,244	\$ 1,399	\$ 11,841	\$ 22,484
Incurred claims and changes in estimates	8,510	8,884	99,959	117,353
Claims paid	<u>(8,840)</u>	<u>(4,641)</u>	<u>(102,940)</u>	<u>(116,421)</u>
Unpaid claims, December 31, 2022	<u>\$ 8,914</u>	<u>\$ 5,642</u>	<u>\$ 8,860</u>	<u>\$ 23,416</u>

The City is exposed to various risks of loss related to torts; theft of, damage to, or destruction of assets; errors or omissions; and job-related illnesses or injuries to employees. The City individually handles these risks of loss through combinations of risk retention and commercial insurance.

The City has entered into contracts with two companies to service its workers' compensation and auto liability claims, which are reported in the Risk Management Internal Service Fund. Under the terms of the contracts, the City is required to maintain a minimum level of funds in a "loss fund account" with the company for the purpose of paying claims and losses. These amounts are recorded as an asset since the self-insurance risk is not transferred to the service agent. The City records a liability for the estimated outstanding losses at year-end, which includes an accrual for incurred but not reported claims, that is included in accounts payable and other current liabilities in the statement of net position. The estimate of claims liability also includes amounts for incremental claim adjustment expenses related to specific claims and other claim adjustment expenses, regardless of whether allocated to specific claims. The City accounts for the self-insurance programs in internal service funds.

The City has elected to be self-insured through a high-deductible health insurance plan that is offered to current and eligible retired employees. There is a \$500 stop-loss coverage for each employee per annum. The City has contracted with a third party to service its health insurance claims. The City records a liability for the estimated outstanding claims at year-end in the self-insurance fund, which is included in accounts payable and other current liabilities in the statement of net position. The estimate of claims liability also includes amounts for incremental claim adjustment expenses related to specific claims and other claim adjustment expenses regardless of whether allocated to specific claims.

There have been no significant reductions in insurance coverage in the last year. Settled claims have not exceeded commercial coverage in the past three years.

**19. Parking Meter Concession Agreement**

Effective December 22, 2010, the City entered into an agreement with a concessionaire to operate and maintain the City's parking meter system, including collecting parking meter revenues and issuing parking tickets for violations related to the parking meter system and residential parking permits. The objective of entering into this agreement was to modernize the parking meter system and to provide residents and visitors with more convenient parking options and to provide the City with funding for infrastructure improvements. In addition to operating and maintaining the City's parking meter system, the concessionaire is responsible for making all capital improvements required to be completed during the 50-year term of the agreement, including implementing multi-space meters in certain locations and installing meters that are capable of accepting electronic payments. The City accounts for this transaction in accordance with the requirements of GASB Statement No. 60, *Accounting and Financial Reporting for Service Concession Arrangements*.

The City receives a share of all revenues generated from the parking meter system. During 2022, the City's monthly share of the revenue was 30% for parking meter revenues collected between \$0 and \$724 and 60% for all such amounts above \$724 (each tier amount is adjusted for inflation annually). Under the agreement, the City must compensate the concessionaire to offset its losses for certain events, which include, but are not limited to, the City's removal or temporary closure of parking meters, material changes in the rules and regulations affecting the parking meters or

**CITY OF INDIANAPOLIS**  
**(A Component Unit of the Consolidated City of Indianapolis – Marion County)**  
Notes to Financial Statements  
December 31, 2022  
(Dollars in Thousands)

---

residential permits, and the City's ownership or operation of certain off-street parking developed after the effective date and located within a quarter of a mile of a parking meter space. The City may terminate the concessionaire agreement but would be required to make a termination payment ranging from \$8,000 to \$19,800 based on the date of termination.

At December 31, 2022, \$15,200 is recorded as a deferred inflow of resources in the government-wide statement of net position for the unamortized portion of upfront payments by the operator to the City. The deferred inflow of resources is being amortized using the straight-line method over the 50-year term of the agreement and, in 2022, \$400 was amortized and recognized as revenue in the government-wide statement of activities.

**20. Related Party Transactions**

The City and the County have entered into a number of management contracts with the Building Authority. Such contracts provide for the construction, operation, and/or maintenance of facilities for use by various departments of the City and the County. In some instances, the City and the County advance funds to the Building Authority for construction of new facilities. In other instances, management contracts are established for existing facilities. Under each of their management contracts, the City and the County designate the Building Authority as their agent and manager for purposes of constructing, maintaining and/or managing the facilities. Maintenance Fees are payable to the Building Authority for facilities covered under management contracts and vary each year based on the operating expense budgets for the facilities. During 2022, the City paid the Building Authority \$2,570 in Maintenance Fees. The City's management contracts expire on various dates through June 30, 2023. The Building Authority is a separate municipal corporation, acting as a joint building authority, whose purpose is to finance, acquire, construct, improve, renovate, equip, operate, maintain, and manage land, governmental buildings, and communication systems for governmental entities within Marion County. Such facilities are sometimes financed by the Building Authority through the issuance of bonded debt. The governing Indiana statute with respect to each of the Building Authority's lease liabilities provides governments shall be obligated to levy annually a tax sufficient to produce each year the necessary funds to pay the lease liabilities to the Building Authority. The City currently has no debt related obligations to the Building Authority.

The legislative body of the City is the same in several respects as that of the County, and the position of the County Executive is the same as the Mayor of Indianapolis. The County provides certain information systems and telephone services to the City. During 2022, the City incurred approximately \$18,544 in information systems costs and \$876 in telephone costs. The City also paid the County \$7,034 of 911 dispatch fees. During 2022, the County paid the City \$746 for fuel charges. As of December 31, 2022, the County owed the City \$1,901 for court costs. In addition, the City and County both act in capacities as pass through and subrecipient agents for federal and state grants.

The City and County purchase certain insurance policies, which cover risks of both entities. The City and County pay premiums associated with their own respective portions of the coverage. The City provides certain administrative services to the County, including purchasing, legal, and other general administration. The City funds such services through a countywide tax levy. The County does not compensate the City for these services. Conversely, Marion County provides, at no compensation, criminal, civil, juvenile, and probate court services to all municipalities and unincorporated areas in the County and administers the property tax administration and collection system for the same jurisdictions and the Marion County jail and lockup.

In 2010, the City entered into an Interlocal Cooperation Agreement to provide \$8,000 of funding annually to the Capital Improvement Board of Managers (of Marion County, Indiana) ("CIB") to further their mutual purposes, including to better assure their funding sources for Visit Indy, Inc. Visit Indy, Inc. is an important body through which the convention and visitor industry and the commercial, industrial, and cultural interests of Indianapolis and its citizens are promoted and publicized, including the CIB's capital improvements. The agreement renews annually and assumes the same terms and level of funding, subject to certain factors (including the availability of funds), unless either party gives a six-month termination notice prior to the end of the annual cycle.

In connection with a Public Safety Support Agreement dated March 1, 2013, between the City and the CIB, the CIB is to pay a portion of the Marion County Admissions Taxes and Marion County Supplemental Auto Rental Excise Taxes it receives on an annual basis to the City to be used for public safety purposes. The CIB is to pay to the City 25% of the revenue received from the most recently enacted increase in the admissions tax, which in 2022 amounted to \$2,318; however, per the agreement, such amount shall never exceed \$3,000 annually. The term of the Public Safety Agreement extends to February 28, 2025 and automatically renews for additional four-year periods until terminated by either party.

The City and County have transactions with each other throughout the year. As part of the accounts receivable and accounts payable analyses, a number of these transactions are determined to be accruals. At December 31, 2022, the City recorded \$1,955 in accounts payable to Marion County, and the County recorded \$360 in accounts payable to the City of Indianapolis.

In 2018, the City entered into an agreement with The Health and Hospital Corporation of Marion County ("HHC"), whereas HHC agreed to support a portion of the startup and capital costs associated with the Community Justice Center Campus, which includes an Assessment and Intervention Center ("AIC"). HHC will provide support from 2018 through 2025, as follows: \$4,700 in 2018, \$2,500 in 2019, \$2,500 in 2020, and \$2,700 annually in 2021-2025. The AIC helps by diverting individuals from infective punitive measures, including incarceration, and into appropriate care delivery models that provide rapid and integrated patient care, to address mental health, addiction, homelessness, and other socio-economic issues.

**CITY OF INDIANAPOLIS**  
**(A Component Unit of the Consolidated City of Indianapolis – Marion County)**  
Notes to Financial Statements  
December 31, 2022  
(Dollars in Thousands)

The City provides an annual contribution to support operating and capital expenses to the Indianapolis City Market Corporation (“Market”), a not-for-profit organization formed for the purpose of operating the Indianapolis City Market. In 2022, the City contributed \$636.

**21. Interfund Transactions and Balances**

Funds are transferred from one fund to support expenditures of other funds in accordance with authority established for the individual fund. The composition of interfund receivable and payable balances as of December 31, 2022 is as follows:

Receivable Fund	Payable Fund	Amount
General Fund	Nonmajor Governmental Funds	\$ 14,775

Interfund transfers for the year ended December 31, 2022 consisted of the following:

Transfers Out	Transfers In				Total
	General Fund	Revenue Bond Debt Service Fund	Redevelopment Tax Increment	Nonmajor Governmental Funds	
General Fund	\$ —	\$ 5,692	\$ —	\$ 57,961	\$ 63,653
Revenue Bond Debt Service Fund	350	—	—	52,723	53,073
Redevelopment Tax Increment	—	—	—	23,063	23,063
Nonmajor Governmental Funds	72,327	12,104	20,954	32,626	138,011
Total transfers	\$ 72,677	\$ 17,796	\$ 20,954	\$ 166,373	\$ 277,800

Interfund transfers were used to (1) move revenues from the fund that an ordinance or budget requires to collect them to the fund that ordinance or budget requires to expend them or (2) use unrestricted revenues collected in the general fund to finance capital improvements and other funds in accordance with budgetary authorization.

**22. Explanation of Certain Differences between the Governmental Fund Financial Statements and the Government-Wide Financial Statements**

Long-term liabilities applicable to the City’s governmental activities are not due and payable in the current period and, accordingly, are not reported as fund liabilities. Interest on long-term debt is not accrued in governmental funds, but rather is recognized as an expenditure when due. All liabilities — both current and long term — are reported in the statement of net position.

Details of the adjustment for these reconciling items between the *fund balances – total governmental funds* and *total net position of governmental activities*, as reported in the government-wide statement of net position at December 31, 2022, follow:

Bonds and notes payable	\$ 1,394,741
Unamortized premiums, net of discounts	97,674
Amounts recorded as matured bonds and notes payable at December 31, 2022	(13,157)
Lease liabilities	46,131
Financed purchase obligations	31,929
Net pension liabilities	749,728
Postemployment benefit liability	215,784
Compensated absences	41,428
Combined adjustment	\$ 2,564,258

**CITY OF INDIANAPOLIS**  
**(A Component Unit of the Consolidated City of Indianapolis – Marion County)**  
Notes to Financial Statements  
December 31, 2022  
(Dollars in Thousands)

Issuance of long-term debt provides current financial resources to governmental funds, while repayment of the principal of long-term debt consumes current financial resources of governmental funds. Neither transaction, however, has any effect on the change in net position. Also, governmental funds report the effect of premiums, discounts, and similar items when debt is first issued, whereas these amounts are deferred and amortized in the statement of activities. Details of the adjustments for these reconciling items between *net changes in fund balances – total governmental funds* and *changes in net position of governmental activities*, as reported in the government-wide statement of activities for the year ended December 31, 2022, follow:

Debt issued:	
General obligation bonds	\$ 23,500
Tax increment bonds, excluding accretion on capital appreciation bonds of \$8,741	195,877
Revenue bonds	50,000
Notes payable	34,767
Lease liabilities	8,346
Financed purchase obligations	32,755
Unamortized premiums	31,973
Combined adjustment	<u>\$ 377,218</u>
Repayments:	
Bond principal, less decrease in matured bonds payable of \$2,350	\$ 129,355
Notes payable	73,585
Lease liabilities	9,378
Financed purchase obligations	1,136
Combined adjustment	<u>\$ 213,454</u>

**23. Deficit Fund Balances and Net Position**

Negative fund balances by fund are as follows:

Deficit Fund Balances	2022
<b>Major Fund</b>	
Coronavirus Federal Stimulus	\$ (1,312)
<b>Nonmajor Special Revenue</b>	
Federal Grants	\$ (8,952)
<b>Internal Service Fund</b>	
Risk Management	\$ (2,906)

The federal grants fund negative fund balance will be covered by future grant reimbursements. The risk management internal service fund negative fund balance will be covered by future charges to City departments.

**24. Subsequent Events**

On May 3, 2023, the City issued its Economic Development Tax Increment Revenue Bonds, Series 2023 (1827 Lofts Project) in an amount of \$4,393. The proceeds will be provided to the developer for the purposes of providing funds to pay for the construction, acquisition and equipping of a multi-family residential development known as the 1827 Lofts Project and consisting of approximately 166 new construction, high-quality apartment units with associated parking and amenities, as well as approximately 1,500 square feet of retail and commercial space, and costs incurred in connection with the issuance of the bonds. The bonds mature on February 1, 2048, and have an interest rate of 8%

**CITY OF INDIANAPOLIS**  
**(A Component Unit of the Consolidated City of Indianapolis – Marion County)**  
Notes to Financial Statements  
December 31, 2022  
(Dollars in Thousands)

---

On May 9, 2023, the City issued its Economic Development Tax Increment Revenue Bonds, Series 2023 (Federally Taxable-Guildford Midtown Project) in an amount of \$5,847. A portion of the proceeds will be provided to the developer to finance the acquisition, construction, equipping and preservation of approximately 232 residential rental units ranging from studios with 523 square feet to a 3-bedroom unit with 2,025 square feet; approximately 250 parking spaces; and approximately 3,820 square feet of retail/commercial space with outdoor seating. A portion of the proceeds will also be used to pay all or a portion of capitalized interest on the bonds through February 1, 2026. On the closing date, \$1 was paid to the developer; the 2nd installment of \$5,846 will be made upon the developers' fulfillment of its obligation to invest an amount greater than or equal to the purchase price of the project from sources other than principal of the bonds. The bonds mature on February 1, 2048, and have an interest rate of 6.85%

On June 13, 2023, the City entered into a financing agreement in the amount of \$19,780 with the Building Authority to finance a new neighborhood and family recreation center at Frederick Douglass Park. This is a 30-year financed purchase obligation with payments beginning August 1, 2024.

In 2021, nationwide settlements were reached to resolve opioid litigation brought by states and local political subdivisions against three pharmaceutical distributors and one manufacturer of opioids. Subsequent to year-end, a second phase of settlements were reached with five major drugstore chains. The new agreements will have varying lengths, and the estimated second phase settlement amount to be received by the City is \$30,757. The Indiana Attorney General's office is consolidating the second phase with the 2021 original settlements. As a result, the initial City settlement of \$36,743 will be revised to \$67,500, payable over 18 years.

On June 15, 2023, the City purchased a 3.5-acre property for \$54,300 known as Pan Am Plaza. The land was purchased as part of a larger redevelopment of the Pan Am block, located at the southwest corner of Georgia and Illinois streets, that will include an expansion of the Indiana Convention Center and a convention center connected headquarters hotel. On June 5, 2023, the City-County Council authorized the issuance of bonds in an aggregate principal amount not to exceed \$625,000 to provide funds for the construction, installation and equipping of an approximately 800-guestroom convention center connected headquarters hotel, with functionally related and subordinated facilities, appurtenances and improvements on the site. The bond term will not exceed forty-four years and principal and interest on the bonds will be payable from available revenues generated from the operation of the hotel project.

**(This page intentionally left blank)**

Required  
Supplementary Information

Required  
Supplementary Information



**CITY OF INDIANAPOLIS**  
**(A Component Unit of the Consolidated City of Indianapolis - Marion County)**  
**General Fund**  
**Schedule of Revenues, Expenditures, and Changes in Fund Balance**  
**Budget and Actual – Budgetary Basis (Required Supplementary Information)**  
Year ended December 31, 2022  
*(In thousands)*

	<u>Original budget</u>	<u>Final budget</u>	<u>Actual</u>	<b>Variance with final budget – positive (negative)</b>
Revenues:				
Taxes	\$ 457,306	\$ 472,543	\$ 479,266	\$ 6,723
Licenses and permits	16,012	16,012	17,549	1,537
Charges for services	82,148	82,148	78,098	(4,050)
Intergovernmental revenues	87,112	87,112	88,779	1,667
Traffic violations and court fees	1,882	2,382	2,444	62
Intragovernmental revenues	10,451	13,698	6,321	(7,377)
Interest and other operating revenues	19,109	19,109	17,661	(1,448)
Total revenues	<u>674,020</u>	<u>693,004</u>	<u>690,118</u>	<u>(2,886)</u>
Expenditures:				
Current:				
General government	29,303	30,460	30,387	73
Public safety	458,826	465,667	464,550	1,117
Public works	129,682	130,302	125,327	4,975
Health and welfare	846	876	3,623	(2,747)
Cultural and recreation	29,681	29,324	27,613	1,711
Urban redevelopment and housing	9,304	11,098	6,278	4,820
Economic development and assistance	974	1,174	2,669	(1,495)
Capital outlays	50,684	74,551	72,370	2,181
Total expenditures	<u>709,300</u>	<u>743,452</u>	<u>732,817</u>	<u>10,635</u>
Deficiency of revenues under expenditures	<u>(35,280)</u>	<u>(50,448)</u>	<u>(42,699)</u>	<u>7,749</u>
Other financing sources:				
Sale and lease of property	1,849	1,849	1,155	(694)
Transfers in	42,569	3,629	10,084	6,455
Total other financing sources	<u>44,418</u>	<u>5,478</u>	<u>11,239</u>	<u>5,761</u>
Revenues and other financing sources over (under) expenditures and other financing uses	9,138	(44,970)	(31,460)	13,510
Fund balance at beginning of year	297,824	232,029	263,117	31,088
Cancellation of purchase orders and other	(65,795)	41,637	17,516	(24,121)
Fund balance at end of year	<u>\$ 241,167</u>	<u>\$ 228,696</u>	<u>\$ 249,173</u>	<u>\$ 20,477</u>

The accompanying notes are an integral part of the financial statements.

**CITY OF INDIANAPOLIS**  
**(A Component Unit of the Consolidated City of Indianapolis - Marion County)**  
**Coronavirus Federal Stimulus Fund**  
**Schedule of Revenues, Expenditures, and Changes in Fund Balance**  
**Budget and Actual – Budgetary Basis (Required Supplementary Information)**  
Year ended December 31, 2022  
*(In thousands)*

	<u>Original budget</u>	<u>Final budget</u>	<u>Actual</u>	<b>Variance with final budget – positive (negative)</b>
Revenues:				
Intergovernmental revenues	\$ —	\$ 236,616	\$ 236,616	\$ —
Interest and other operating revenues	—	—	5,415	5,415
Total revenues	<u>—</u>	<u>236,616</u>	<u>242,031</u>	<u>5,415</u>
Expenditures:				
Current:				
General government	—	90,212	89,336	876
Public safety	—	58,380	58,380	—
Health and welfare	—	29,367	29,367	—
Cultural and recreation	—	28	28	—
Urban redevelopment and housing	—	13,514	13,514	—
Economic development and assistance	—	15,095	15,095	—
Capital outlays	<u>—</u>	<u>29,996</u>	<u>29,996</u>	<u>—</u>
Total expenditures	<u>—</u>	<u>236,592</u>	<u>235,716</u>	<u>876</u>
Excess (deficiency) of revenues over (under) expenditures	<u>—</u>	<u>24</u>	<u>6,315</u>	<u>6,291</u>
Revenues and other financing sources over (under) expenditures and other financing uses	—	24	6,315	6,291
Fund balance at beginning of year	—	—	—	—
Cancellation of purchase orders and other	<u>—</u>	<u>(24)</u>	<u>(6,315)</u>	<u>(6,291)</u>
Fund balance at end of year	<u>\$ —</u>	<u>\$ —</u>	<u>\$ —</u>	<u>\$ —</u>

The accompanying notes are an integral part of the financial statements.

**CITY OF INDIANAPOLIS**  
**(A Component Unit of the Consolidated City of Indianapolis – Marion County)**  
Notes to Required Supplementary Information – Budgetary Comparison Schedule  
December 31, 2022  
*(In thousands)*

---

**1. Budgets and Budgetary Accounting**

- A) The City of Indianapolis (“City”) is required by state statute and City-County Council (“Council”) ordinance to adopt annual budgets for all subfunds of the General Fund; all Special Revenue Funds, except the Cable Franchise PEG Grants Fund; all Debt Service Funds; the City Cumulative Capital Development, the County Cumulative Capital Development, and the Fire Cumulative Capital Projects Funds; and the Police Pension and Firefighters Pension Trust Funds to the object level of control. These budgets require Council approval and are prepared for each departmental division and approved at the five object levels of expenditure (personal services, supplies, other services and charges, capital outlay, and internal charges). In addition, control is achieved for other capital projects funds by the original bond resolutions that are required by state statute to be approved by the Council for all bond issues for taxing units within the consolidated City. These originating bond resolutions serve as the basis for the appropriations for capital projects. These appropriations do not lapse at year-end. All other City sources of finance for capital projects are required to be appropriated within the providing City budgetary fund. Control over spending from funds which are not subject to the Council appropriation process is accomplished by the requirement that all disbursements of such funds be made only to a budgeted fund.

The Council may amend appropriations by transferring unencumbered appropriations from one object to another within the same fund and may also make additional appropriations to the extent of unappropriated fund balances. Transfers of appropriations from one line item to another within the object level of control may be approved by City management. During the year, for the General Fund, the following supplementary appropriations were properly approved:

	<u>General Fund</u>
Original appropriations	\$ 709,300
Revisions	34,152
Revised appropriations	<u>\$ 743,452</u>

The budget information disclosed includes the budget ordinances as amended. Internal charges are recorded as expenditures in one fund and negative expenditures in the receiving fund. Budgeted disbursements may exceed estimated revenues as appropriations contemplate the utilization of beginning fund balances. Except for Capital Projects Funds (excluding Cumulative Capital Development Funds) and certain Special Revenue Funds, unencumbered appropriations lapse with the expiration of the budgetary period. All budgets are prepared on the cash basis of accounting with the exception of revenues received in the current year but budgeted for in a prior year and that encumbrances and certain accounts payable are treated as expenditures.

- B) The City’s procedures in establishing the budget are as follows:
- 1) Prior to July 1, the Department Directors, in conjunction with the Mayor’s staff and the City Controller, develop budgets for the subsequent calendar year for the individual divisions within their respective departments.
  - 2) In July, the City Controller prepares the budget ordinances, which are introduced by the Mayor to the Council at the first August Council meeting. In developing these budgets, the City Controller adds the June 30 cash and investment balances to estimated revenues to be received and expenditures to be incurred from July 1 through December 31 in arriving at a December 31 “projected budgetary fund balance.” The projected budgetary fund balance and estimated revenues for the ensuing year are reduced by that year’s budgeted expenditures in developing the amount to be funded from ad valorem property taxes, to the extent of the maximum levy. By using this procedure, any actual results favorable or unfavorable to those estimated for any year are incorporated into the subsequent year’s budget.
  - 3) The Council assigns the introduced budgets to the appropriate Council Committees. In August and September, each Council Committee holds public hearings on the budget of the department or division for which it is responsible.
  - 4) Before Council budget ordinances are approved by the Council, they are advertised by the City Controller twice in a local newspaper prior to the last Council meeting in September. The Council may not pass a budget above the level advertised. The Mayor may veto separate items of an approved budget ordinance, but the Council may override a veto by a two-thirds vote.

**CITY OF INDIANAPOLIS**  
**(A Component Unit of the Consolidated City of Indianapolis – Marion County)**  
Notes to Required Supplementary Information – Budgetary Comparison Schedule  
December 31, 2022  
*(In thousands)*

- 5) The Indiana Department of Local Government Finance (DLGF) makes the final review of the budget. It can revise, reduce, or restore on appeal budgets, levies, and tax rates removed by the Council. Except for Debt Service Funds, DLGF may not increase a budget, levy, or tax rate above the level originally advertised. If the budgets seek to exceed the tax limits of the state control laws, an excess levy may be granted if the excess levy meets state law requirements and is approved by DLGF. DLGF is required to certify the budgets, levies, and rates by December 31 of the year preceding the budget year, unless the City issues debt after December 1 in the year preceding the budget year, in which case DLGF will have until January 15.
- 6) The City’s maximum permissible annual ad valorem property tax levy is restricted by Indiana law, with certain adjustments and exceptions, to the prior year’s maximum permissible ad valorem property tax levy adjusted by the average growth factor in nonfarm income in the State of Indiana.
- C) Encumbrance accounting, under which purchase orders, contracts, and other commitments for the expenditures of monies are recorded in order to reserve that portion of the applicable appropriation, is employed as an extension of formal budgetary integration in the General Fund, Special Revenue Funds, Debt Service Funds, Capital Projects Funds, and Pension Trust Funds. Encumbrances do not lapse with the expiration of the budget period.

**2. Budget/GAAP Reporting Differences**

Adjustments necessary to convert the results of 2022 operations from a budgetary basis to a GAAP basis are as follows:

	<b>General Fund</b>	<b>Coronavirus Federal Stimulus Fund</b>
Revenues over (under) expenditures and other financing sources (uses) (budgetary basis)	\$ (31,460)	\$ 6,315
Adjustments:		
Accrued revenues	62,576	(94,553)
Accrued expenditures	(82,973)	(10,960)
Transfers, net	(1,060)	-
Encumbrances	49,392	114,187
Expenditures from prior year encumbrances	<u>(95,767)</u>	<u>(16,359)</u>
Net change in fund balances (GAAP basis)	<u>\$ (99,292)</u>	<u>\$ (1,370)</u>

**CITY OF INDIANAPOLIS**  
**(A Component Unit of the Consolidated City of Indianapolis - Marion County)**  
**Required Supplementary Information - Pension - Police Pre-1977 Plan**  
**Schedule of Changes in Net Pension Liability - Last Ten Fiscal Years**  
*(In thousands)*

	<u>2022</u>	<u>2021</u>	<u>2020</u>	<u>2019</u>	<u>2018</u>	<u>2017</u>	<u>2016</u>	<u>2015</u>	<u>2014</u>	<u>2013</u>
<b>Total Pension Liability</b>										
Service cost	\$ —	\$ 66	\$ 147	\$ 173	\$ 227	\$ 268	\$ 469	\$ 598	\$ 430	\$ 244
Interest cost	5,210	5,787	8,748	12,161	11,667	13,538	12,070	12,393	18,697	22,693
Expected return on assets	—	—	—	(5)	—	—	—	—	—	—
Plan amendments	—	—	—	2,889	—	—	—	—	—	—
Experience (gains)/losses	8,429	(879)	(7,115)	(1,608)	(333)	(253)	270	(2,747)	—	(4,432)
Assumption changes	(75,441)	(850)	(3,099)	38,078	(13,830)	20,399	(29,167)	(1,539)	61,324	65,959
Projected benefit payments	(26,991)	(26,941)	(27,361)	(28,160)	(28,513)	(28,723)	(28,979)	(29,171)	(29,267)	(28,886)
Net change in total pension liability	(88,793)	(22,817)	(28,680)	23,528	(30,782)	5,229	(45,337)	(20,466)	51,184	55,578
Total pension liability - beginning	379,854	402,671	431,351	407,823	438,605	433,376	478,713	499,179	447,995	392,417
Total pension liability - ending	\$ <u>291,061</u>	\$ <u>379,854</u>	\$ <u>402,671</u>	\$ <u>431,351</u>	\$ <u>407,823</u>	\$ <u>438,605</u>	\$ <u>433,376</u>	\$ <u>478,713</u>	\$ <u>499,179</u>	\$ <u>447,995</u>
<b>Plan Fiduciary Net Position</b>										
Employer contributions	\$ 27,771	\$ 27,376	\$ 27,377	\$ 28,138	\$ 28,183	\$ 28,303	\$ 28,887	\$ 29,116	\$ 28,762	\$ 29,503
Actual benefit payments	(26,532)	(27,737)	(27,833)	(28,133)	(28,532)	(28,570)	(28,761)	(30,153)	(28,783)	(28,469)
Net change in plan fiduciary net position	1,239	(361)	(456)	5	(349)	(267)	126	(1,037)	(21)	1,034
Plan fiduciary net position (deficit) - beginning	(357)	4	460	455	804	1,071	945	1,982	2,003	969
Plan fiduciary net position (deficit) - ending	\$ <u>882</u>	\$ <u>(357)</u>	\$ <u>4</u>	\$ <u>460</u>	\$ <u>455</u>	\$ <u>804</u>	\$ <u>1,071</u>	\$ <u>945</u>	\$ <u>1,982</u>	\$ <u>2,003</u>
<b>City's Net Pension Liability</b>	\$ <u>290,179</u>	\$ <u>380,211</u>	\$ <u>402,667</u>	\$ <u>430,891</u>	\$ <u>407,368</u>	\$ <u>437,801</u>	\$ <u>432,305</u>	\$ <u>477,768</u>	\$ <u>497,197</u>	\$ <u>445,992</u>

(Continued)

**CITY OF INDIANAPOLIS**  
**(A Component Unit of the Consolidated City of Indianapolis - Marion County)**  
**Required Supplementary Information - Pension - Police Pre-1977 Plan**  
**Schedule of Changes in Net Pension Liability - Last Ten Fiscal Years**  
*(In thousands)*

**Notes to Schedule**

*Benefit changes:* None

*Changes in assumptions:* The following changes in assumptions were made from the December 31, 2021 valuation.

- *Discount Rate*: The discount rate used for the December 31, 2022 valuation was 4.12%, as directed by INPRS, based on the Barclay's 20-year Municipal Bond Index as of December 31, 2022. This is an increase from the 1.39% used for the December 31, 2021 valuation.
- *Cost-of-living-adjustment (COLA)*: For converted members, the July 1, 2022 COLA of 3.00% was used in place of the ongoing valuation assumption to reflect the known increase. Beginning July 1, 2023, the assumption reverts to the assumed annual rate of 1.95%. For non-converted members, there was no change and the COLA remains at 2.65%.

**CITY OF INDIANAPOLIS**  
**(A Component Unit of the Consolidated City of Indianapolis - Marion County)**  
**Required Supplementary Information - Pension - Firefighters' Pre-1977 Plan**  
**Schedule of Changes in Net Pension Liability - Last Ten Fiscal Years**  
*(In thousands)*

	<u>2022</u>	<u>2021</u>	<u>2020</u>	<u>2019</u>	<u>2018</u>	<u>2017</u>	<u>2016</u>	<u>2015</u>	<u>2014</u>	<u>2013</u>
<b>Total Pension Liability</b>										
Service cost	\$ 67	\$ 67	\$ 50	\$ 78	\$ 122	\$ 167	\$ 330	\$ 327	\$ 299	\$ 187
Interest cost	4,906	5,297	7,966	11,096	10,624	12,356	11,149	11,500	17,406	21,297
Expected return on assets	—	—	—	2	—	—	—	—	—	—
Plan amendments	—	—	—	2,396	—	—	—	—	—	—
Experience (gains)/losses	13,489	7,866	(4,097)	466	1,348	(4,522)	(552)	(628)	—	(3,704)
Assumption changes	(69,767)	(788)	(2,574)	33,418	(12,231)	17,990	(26,359)	(1,395)	55,244	59,984
Projected benefit payments	<u>(26,559)</u>	<u>(25,961)</u>	<u>(26,420)</u>	<u>(27,196)</u>	<u>(27,432)</u>	<u>(27,655)</u>	<u>(28,046)</u>	<u>(28,340)</u>	<u>(28,489)</u>	<u>(29,490)</u>
Net change in total pension liability	<u>(77,864)</u>	<u>(13,519)</u>	<u>(25,075)</u>	<u>20,260</u>	<u>(27,569)</u>	<u>(1,664)</u>	<u>(43,478)</u>	<u>(18,536)</u>	<u>44,460</u>	<u>48,274</u>
Total pension liability - beginning	<u>352,667</u>	<u>366,186</u>	<u>391,261</u>	<u>371,001</u>	<u>398,570</u>	<u>400,234</u>	<u>443,712</u>	<u>462,248</u>	<u>417,788</u>	<u>369,514</u>
Total pension liability - ending	<u>\$ 274,803</u>	<u>\$ 352,667</u>	<u>\$ 366,186</u>	<u>\$ 391,261</u>	<u>\$ 371,001</u>	<u>\$ 398,570</u>	<u>\$ 400,234</u>	<u>\$ 443,712</u>	<u>\$ 462,248</u>	<u>\$ 417,788</u>
<b>Plan Fiduciary Net Position</b>										
Employer contributions	\$ 27,498	\$ 26,151	\$ 26,488	\$ 27,946	\$ 27,707	\$ 27,486	\$ 27,974	\$ 28,150	\$ 29,163	\$ 29,209
Actual benefit payments	<u>(26,202)</u>	<u>(26,868)</u>	<u>(26,643)</u>	<u>(27,477)</u>	<u>(28,209)</u>	<u>(27,830)</u>	<u>(27,727)</u>	<u>(28,383)</u>	<u>(28,395)</u>	<u>(29,567)</u>
Net change in plan fiduciary net position	<u>1,296</u>	<u>(717)</u>	<u>(155)</u>	<u>469</u>	<u>(502)</u>	<u>(344)</u>	<u>247</u>	<u>(233)</u>	<u>768</u>	<u>(358)</u>
Plan fiduciary net position (deficit) - beginning	<u>(609)</u>	<u>108</u>	<u>263</u>	<u>(206)</u>	<u>296</u>	<u>640</u>	<u>393</u>	<u>626</u>	<u>(142)</u>	<u>216</u>
Plan fiduciary net position (deficit) - ending	<u>\$ 687</u>	<u>\$ (609)</u>	<u>\$ 108</u>	<u>\$ 263</u>	<u>\$ (206)</u>	<u>\$ 296</u>	<u>\$ 640</u>	<u>\$ 393</u>	<u>\$ 626</u>	<u>\$ (142)</u>
<b>City's Net Pension Liability</b>	<u>\$ 274,116</u>	<u>\$ 353,276</u>	<u>\$ 366,078</u>	<u>\$ 390,998</u>	<u>\$ 371,207</u>	<u>\$ 398,274</u>	<u>\$ 399,594</u>	<u>\$ 443,319</u>	<u>\$ 461,622</u>	<u>\$ 417,930</u>

(Continued)

**CITY OF INDIANAPOLIS**  
**(A Component Unit of the Consolidated City of Indianapolis - Marion County)**  
**Required Supplementary Information - Pension - Firefighters' Pre-1977 Plan**  
**Schedule of Changes in Net Pension Liability - Last Ten Fiscal Years**  
*(In thousands)*

**Notes to Schedule**

*Benefit changes:* None

*Changes in assumptions:* The following changes in assumptions were made from the December 31, 2021 valuation.

- *Discount Rate* : The discount rate used for the December 31, 2022 valuation was 4.12%, as directed by INPRS, based on the Barclay's 20-year Municipal Bond Index as of December 31, 2022. This is an increase from the 1.39% used for the December 31, 2021 valuation.  
used for the December 31, 2020 valuation.
- *Cost-of-living-adjustment (COLA)*: For converted members, the July 1, 2022 COLA of 3.00% was used in place of the ongoing valuation assumption to reflect the known increase. Beginning July 1, 2023, the assumption reverts to the assumed annual rate of 1.95%. For non-converted members, there was no change and the COLA remains at 2.65%.



**CITY OF INDIANAPOLIS**  
**(A Component Unit of the Consolidated City of Indianapolis - Marion County)**  
**Required Supplementary Information - Pensions**  
**Schedule of Net Pension Liability and Related Ratios - Last Ten Fiscal Years**  
*(In thousands)*

Actuarial valuation date	Total pension liability (a)	Plan fiduciary net position (b)	City's net pension liability (a-b)	Fiduciary net position as a percentage of total pension liability (b/a)	City's covered payroll* (c)	City's net pension liability as a percentage of covered payroll ((a-b)/c)
<b>Police Pre-1977 Plan</b>						
12/31/2022	\$ 291,061	\$ 882	\$ 290,179	0.30 %	\$ 376	77,175.3 %
12/31/2021	379,854	(357)	380,211	(0.09)	462	82,296.8
12/31/2020	402,671	4	402,667	0.00	718	56,081.8
12/31/2019	431,351	460	430,891	0.11	1,022	42,161.5
12/31/2018	407,823	455	407,368	0.11	1,469	27,731.0
12/31/2017	438,605	804	437,801	0.18	1,498	29,225.7
12/31/2016	433,376	1,071	432,305	0.25	1,824	23,700.9
12/31/2015	478,713	945	477,768	0.20	1,645	29,043.6
12/31/2014	499,179	1,982	497,197	0.40	1,805	27,545.5
12/31/2013	447,995	2,003	445,992	0.45	1,891	23,585.0
<b>Firefighters' Pre-1977 Plan</b>						
12/31/2022	274,803	687	274,116	0.25	125	219,292.8
12/31/2021	352,667	(609)	353,276	(0.17)	127	278,170.1
12/31/2020	366,186	108	366,078	0.03	149	245,689.9
12/31/2019	391,261	263	390,998	0.07	250	156,399.2
12/31/2018	371,001	(206)	371,207	(0.06)	709	52,356.4
12/31/2017	398,570	296	398,274	0.07	1,115	35,719.6
12/31/2016	400,234	640	399,594	0.16	1,436	27,826.9
12/31/2015	443,712	393	443,319	0.09	1,175	37,729.3
12/31/2014	462,248	626	461,622	0.14	1,370	33,695.0
12/31/2013	417,788	(142)	417,930	0.03	1,533	27,262.2

\* Plans closed to new members

**CITY OF INDIANAPOLIS**  
**(A Component Unit of the Consolidated City of Indianapolis - Marion County)**  
**Required Supplementary Information - Pensions**  
**Schedule of Proportionate Share of Net Pension Liability - Last Ten Fiscal Years**  
*(In thousands)*

	<u>2022</u>	<u>2021</u>	<u>2020</u>	<u>2019</u>	<u>2018</u>	<u>2017</u>	<u>2016</u>	<u>2015</u>	<u>2014</u>
<b>1977 Police and Firefighters' Plan</b>									
City's proportion of the net pension liability (asset)	22.23%	21.66%	22.23%	22.13%	22.59%	22.89%	22.60%	22.75%	22.01%
City's proportionate share of the net pension liability (asset)	\$ 144,013	\$ (128,005)	\$ 53,985	\$ 2,040	\$ (19,856)	\$ (3,532)	\$ 20,079	\$ (33,609)	\$ (11,223)
City's covered payroll	\$ 224,700	\$ 205,630	\$ 206,168	\$ 195,643	\$ 190,221	\$ 185,605	\$ 174,687	\$ 169,660	\$ 156,274
City's proportionate share of the net pension liability (asset) as a percentage of its covered payroll	64.09%	(62.25)%	26.18%	1.04%	(10.44)%	(1.90)%	11.49%	(19.81)%	(7.18)%
Plan fiduciary net position as a percentage of the total pension liability (asset)	94.72%	96.48%	98.30%	98.60%	101.96%	100.29%	98.24%	103.16%	101.08%
<b>PERF</b>									
City's proportion of the net pension liability	1.313%	1.426%	1.470%	1.395%	1.366%	1.360%	1.387%	1.393%	1.375%
City's proportionate share of the net pension liability	\$ 41,420	\$ 18,758	\$ 44,385	\$ 46,106	\$ 46,405	\$ 60,665	\$ 62,935	\$ 56,743	\$ 36,131
City's covered payroll	\$ 75,584	\$ 78,595	\$ 79,334	\$ 72,681	\$ 69,701	\$ 67,458	\$ 66,460	\$ 66,731	\$ 67,127
City's proportionate share of the net pension liability as a percentage of its covered payroll	54.80%	23.87%	55.95%	63.44%	66.58%	89.93%	94.70%	85.03%	53.82%
Plan fiduciary net position as a percentage of the total pension liability	84.86%	83.00%	83.29%	79.38%	79.69% *	76.65%	75.35%	77.35%	84.29%

\* Effective January 1, 2018, funds previously known as annuity savings accounts (which had been reported within defined benefit funds) were recategorized as defined contribution funds based on Internal Revenue Service Private Letter Rulings PLR-193-2016 and PLR-110249-18. DC member balances previously reported within PERF DB fund totals were transferred to the appropriate DC fund as of January 1, 2018.

(Continued)

**CITY OF INDIANAPOLIS**  
**(A Component Unit of the Consolidated City of Indianapolis - Marion County)**  
**Required Supplementary Information - Pensions**  
**Schedule of Proportionate Share of Net Pension Liability - Last Ten Fiscal Years**  
*(In thousands)*

**Notes to Schedule**

*The amounts presented for each fiscal year were determined as of June 30 (measurement date).*

*Benefit changes: None*

*Changes in assumptions: None*

*The amounts presented for PERF do not include the City's discretely presented component unit, the Indianapolis Housing Agency.*

*Required supplementary information is not available for 2013.*

**CITY OF INDIANAPOLIS**  
**(A Component Unit of the Consolidated City of Indianapolis - Marion County)**  
**Required Supplementary Information - Pensions**  
**Schedule of Pension Contributions - Last Ten Fiscal Years**  
*(In thousands)*

	<u>2022</u>	<u>2021</u>	<u>2020</u>	<u>2019</u>	<u>2018</u>	<u>2017</u>	<u>2016</u>	<u>2015</u>	<u>2014</u>
<b>1977 Police and Firefighters' Plan</b>									
Actuarially determined contribution	\$ 40,468	\$ 37,013	\$ 30,248	\$ 25,903	\$ 20,017	\$ 16,540	\$ 25,353	\$ 26,503	\$ 26,211
Contributions in relation to the actuarially determined contribution	\$ 38,882	\$ 38,643	\$ 36,462	\$ 35,627	\$ 33,241	\$ 32,274	\$ 35,650	\$ 33,947	\$ 31,256
Contribution deficiency (excess)	\$ 1,586	\$ (1,630)	\$ (6,214)	\$ (9,724)	\$ (13,224)	\$ (15,734)	\$ (10,297)	\$ (7,444)	\$ (5,045)
City's covered payroll	\$ 180,426	\$ 188,504	\$ 206,261	\$ 201,559	\$ 187,126	\$ 183,122	\$ 179,821	\$ 169,213	\$ 159,052
Contributions as a percentage of covered payroll	21.55 %	20.50 %	17.68 %	17.68 %	17.76 %	17.62 %	19.83 %	20.06 %	19.65 %
<b>PERF</b>									
Actuarially determined contribution	\$ 4,703	\$ 5,244	\$ 4,930	\$ 5,307	\$ 5,463	\$ 6,761	\$ 6,666	\$ 7,682	\$ 7,065
Contributions in relation to the actuarially determined contribution	\$ 6,240	\$ 5,977	\$ 6,361	\$ 6,653	\$ 6,831	\$ 7,188	\$ 7,496	\$ 7,682	\$ 7,065
Contribution deficiency (excess)	\$ (1,537)	\$ (733)	\$ (1,431)	\$ (1,346)	\$ (1,368)	\$ (427)	\$ (830)	\$ —	\$ —
City's covered payroll	\$ 75,329	\$ 72,976	\$ 73,398	\$ 70,551	\$ 67,735	\$ 66,251	\$ 66,984	\$ 68,622	\$ 67,406
Contributions as a percentage of covered payroll	8.28 %	8.19 %	8.67 %	9.43 %	10.08 %	10.85 %	11.19 %	11.19 %	10.48 %
<b>Police Pre-1977 Plan</b>									
Statutorily required contribution	\$ 27,771	\$ 27,376	\$ 27,377	\$ 28,138	\$ 28,183	\$ 28,303	\$ 28,887	\$ 29,116	\$ 28,762
Contributions in relation to the statutorily required contribution	\$ 27,771	\$ 27,376	\$ 27,377	\$ 28,138	\$ 28,183	\$ 28,303	\$ 28,887	\$ 29,116	\$ 28,762
Contribution deficiency (excess)	\$ —	\$ —	\$ —	\$ —	\$ —	\$ —	\$ —	\$ —	\$ —
City's covered payroll*	\$ 376	\$ 462	\$ 718	\$ 1,022	\$ 1,469	\$ 1,498	\$ 1,824	\$ 1,645	\$ 1,805
Contributions as a percentage of covered payroll	7,385.90 %	5,925.54 %	3,812.95 %	2,753.23 %	1,918.52 %	1,889.39 %	1,583.72 %	1,769.97 %	1,593.46 %
<b>Firefighters' Pre-1977 Plan</b>									
Statutorily required contribution	\$ 27,498	\$ 26,151	\$ 26,488	\$ 27,946	\$ 27,707	\$ 27,486	\$ 27,974	\$ 28,150	\$ 29,164
Contributions in relation to the statutorily required contribution	\$ 27,498	\$ 26,151	\$ 26,488	\$ 27,946	\$ 27,707	\$ 27,486	\$ 27,974	\$ 28,150	\$ 29,164
Contribution deficiency (excess)	\$ —	\$ —	\$ —	\$ —	\$ —	\$ —	\$ —	\$ —	\$ —
City's covered payroll*	\$ 125	\$ 127	\$ 149	\$ 250	\$ 709	\$ 1,115	\$ 1,436	\$ 1,175	\$ 1,370
Contributions as a percentage of covered payroll	21,998.40 %	20,591.34 %	17,777.18 %	11,178.40 %	3,907.90 %	2,465.11 %	1,948.05 %	2,395.74 %	2,128.76 %

\* Plans closed to new members

(Continued)

**CITY OF INDIANAPOLIS**  
**(A Component Unit of the Consolidated City of Indianapolis - Marion County)**  
**Required Supplementary Information - Pensions**  
**Schedule of Pension Contributions - Last Ten Fiscal Years**  
*(In thousands)*

**Notes to Schedule**

*The amounts presented for each fiscal year were determined as of June 30 (measurement date).*

*Benefit changes: None*

*Changes in assumptions: None*

*The amounts presented for PERF do not include the City's discretely presented component unit, the Indianapolis Housing Agency.*

*Required supplementary information is not available for 2013.*

**CITY OF INDIANAPOLIS**  
**(A Component Unit of the Consolidated City of Indianapolis - Marion County)**  
**Required Supplementary Information - Other Postemployment Benefit Plan**  
**Schedule of Net OPEB Liability Under GASB 75**  
*(In thousands)*

	<u>2022</u>	<u>2021</u>	<u>2020</u>	<u>2019</u>	<u>2018</u>
<b>TOTAL OPEB LIABILITY</b>					
Service cost	\$ 14,077	\$ 15,616	\$ 13,355	\$ 10,001	\$ 12,338
Interest	5,571	6,065	6,965	9,849	8,374
Economic/demographic gains/losses	-	(11,039)	-	(31,867)	-
Changes in assumptions	(42,055)	(17,454)	16,305	29,142	(15,568)
Benefit payments	<u>(7,764)</u>	<u>(6,838)</u>	<u>(7,093)</u>	<u>(5,893)</u>	<u>(6,154)</u>
Net change in total OPEB liability	(30,171)	(13,650)	29,532	11,232	(1,010)
Total OPEB liability - beginning	260,241	273,891	244,359	233,127	234,137
Total OPEB liability - ending	<u>\$ 230,070</u>	<u>\$ 260,241</u>	<u>\$ 273,891</u>	<u>\$ 244,359</u>	<u>\$ 233,127</u>
<b>PLAN FIDUCIARY NET POSITION</b>					
Contributions - employer	\$ 8,003	\$ 7,134	\$ 7,514	\$ 6,720	\$ 7,190
Net investment income	(516)	194	648	393	103
Benefit payments	(7,764)	(6,839)	(7,093)	(5,893)	(6,154)
Administrative expense	<u>(71)</u>	<u>(80)</u>	<u>(18)</u>	<u>(20)</u>	<u>(36)</u>
Net change in fiduciary net position	(348)	409	1,051	1,200	1,103
Plan fiduciary net position - beginning	14,634	14,225	13,174	11,974	10,871
Plan fiduciary net position - ending	<u>\$ 14,286</u>	<u>\$ 14,634</u>	<u>\$ 14,225</u>	<u>\$ 13,174</u>	<u>\$ 11,974</u>
Net OPEB liability	\$ 215,784	\$ 245,607	\$ 259,666	\$ 231,185	\$ 221,153
Plan fiduciary net position as a percentage of the total OPEB liability	6%	6%	5%	5%	5%
Covered-employee payroll	360,376	359,231	352,958	322,297	311,988
Net OPEB liability as a percentage of covered-employee payroll	60%	68%	74%	72%	71%

**Notes to Schedule**

*The amounts presented for each fiscal year were determined as of December 31.*

*Benefit changes: None*

*Changes in assumptions: Discount rate increased from 2.06% at December 31, 2021 to 3.72% at December 31, 2022.*

*Required supplementary information is not available for 2013 through 2017.*

**CITY OF INDIANAPOLIS**  
**(A Component Unit of the Consolidated City of Indianapolis - Marion County)**  
**Required Supplementary Information - Other Postemployment Benefit Plan**  
**Schedule of OPEB Contributions**  
*(In thousands)*

	<u>2022</u>	<u>2021</u>	<u>2020</u>	<u>2019</u>	<u>2018</u>
Contractually determined contribution	\$ 8,003	\$ 7,134	\$ 7,514	\$ 6,720	\$ 7,190
Contributions in relation to the contractually determined contribution	<u>8,003</u>	<u>7,134</u>	<u>7,514</u>	<u>6,720</u>	<u>7,190</u>
Contribution deficiency (excess)	<u>\$ —</u>	<u>\$ —</u>	<u>\$ —</u>	<u>\$ —</u>	<u>\$ —</u>
Covered-employee payroll	\$ 360,376	\$ 359,231	\$ 352,958	\$ 322,297	\$ 311,988
Contributions as a percentage of covered-employee payroll	2%	2%	2%	2%	2%

**Notes to Schedule**

*Required supplementary information is not available for 2013 through 2017.*

**(This page intentionally left blank)**



Additional  
Supplementary Information

Additional  
Supplementary Information

**CITY OF INDIANAPOLIS**  
**(A Component Unit of the Consolidated City of Indianapolis - Marion County)**  
**Combining Balance Sheet – Nonmajor Governmental Funds by Fund Type**  
December 31, 2022  
*(In thousands)*

	<u>Nonmajor Special Revenue</u>	<u>Nonmajor Debt Service</u>	<u>Nonmajor Capital Projects</u>	<u>Nonmajor Permanent Fund</u>	<u>Total Nonmajor Governmental Funds</u>
<b>ASSETS</b>					
Equity in pooled cash	\$ 1,566	\$ 1,616	\$ 12,171	\$ —	\$ 15,353
Cash and investments with fiscal agents	—	38,075	37,097	376	75,548
Investments	20,054	20,694	249,112	—	289,860
Property taxes receivable	—	441	617	—	1,058
Accounts receivable, less allowance	812	618	309	—	1,739
Due from federal and state governments	20,635	—	—	—	20,635
Long-term receivables, less allowance	25,303	13,742	—	—	39,045
Total assets	<u>\$ 68,370</u>	<u>\$ 75,186</u>	<u>\$ 299,306</u>	<u>\$ 376</u>	<u>\$ 443,238</u>
<b>LIABILITIES, DEFERRED INFLOWS OF RESOURCES AND FUND BALANCES</b>					
Liabilities:					
Matured bonds payable	\$ —	\$ 7,642	\$ —	\$ —	\$ 7,642
Matured interest payable	—	2,666	—	—	2,666
Accounts payable and other accrued liabilities	9,641	661	15,975	—	26,277
Accrued payroll and payroll taxes	109	—	—	—	109
Due to other funds	13,741	—	1,034	—	14,775
Unearned revenue	783	—	—	—	783
Total liabilities	<u>24,274</u>	<u>10,969</u>	<u>17,009</u>	<u>—</u>	<u>52,252</u>
<b>Deferred inflows of resources</b>	<u>31,111</u>	<u>736</u>	<u>919</u>	<u>—</u>	<u>32,766</u>
Fund balances:					
Nonspendable	—	—	—	376	376
Restricted	21,937	63,481	221,153	—	306,571
Committed	—	—	60,225	—	60,225
Unassigned	(8,952)	—	—	—	(8,952)
Total fund balances	<u>12,985</u>	<u>63,481</u>	<u>281,378</u>	<u>376</u>	<u>358,220</u>
Total liabilities, deferred inflows of resources and fund balances	<u>\$ 68,370</u>	<u>\$ 75,186</u>	<u>\$ 299,306</u>	<u>\$ 376</u>	<u>\$ 443,238</u>

The accompanying notes are an integral part of the financial statements.

**CITY OF INDIANAPOLIS**  
**(A Component Unit of the Consolidated City of Indianapolis - Marion County)**  
**Combining Statement of Revenues, Expenditures, and Changes in Fund Balances –**  
**Nonmajor Governmental Funds by Fund Type**  
Year ended December 31, 2022  
*(In thousands)*

	<b>Nonmajor Special Revenue</b>	<b>Nonmajor Debt Service</b>	<b>Nonmajor Capital Projects</b>	<b>Nonmajor Permanent Fund</b>	<b>Total Nonmajor Governmental Funds</b>
Revenues:					
Taxes	\$ 71,525	\$ 28,295	\$ 17,517	\$ —	\$ 117,337
Charges for services	3,149	—	—	—	3,149
Intergovernmental revenues	49,819	—	762	—	50,581
Intragovernmental revenues	—	—	—	—	—
Traffic violations and court fees	4,575	—	—	—	4,575
Interest and other operating revenues	383	30,295	75,241	4	105,923
Total revenues	<u>129,451</u>	<u>58,590</u>	<u>93,520</u>	<u>4</u>	<u>281,565</u>
Expenditures:					
Current:					
General government	2,791	—	—	—	2,791
Public safety	10,419	—	—	—	10,419
Public works	1,240	—	—	—	1,240
Health and welfare	16,952	—	—	—	16,952
Cultural and recreation	789	—	—	—	789
Urban redevelopment and housing	13,076	—	—	—	13,076
Economic development and assistance	177	—	5,384	—	5,561
Debt service:					
Redemption of bonds, notes and financed purchase obligations	5	149,153	826	—	149,984
Interest on bonds and notes	—	40,766	101	—	40,867
Bond and note issuance costs	84	523	1,080	—	1,687
Lease payments and other	161	11,004	4,887	—	16,052
Capital outlays	4,164	—	131,431	—	135,595
Total expenditures	<u>49,858</u>	<u>201,446</u>	<u>143,709</u>	<u>—</u>	<u>395,013</u>
Excess (deficiency) of revenues over (under) expenditures:	<u>79,593</u>	<u>(142,856)</u>	<u>(50,189)</u>	<u>4</u>	<u>(113,448)</u>
Other financing sources (uses):					
Redemption of bonds, notes and financed purchase obligations	—	—	—	—	—
Bonds, notes and financed purchase obligations issued	3,750	18,225	137,273	—	159,248
Premium on bonds and notes issued	—	—	11,265	—	11,265
Refunding bonds issued	—	24,110	—	—	24,110
Transfers in	10	122,103	44,260	—	166,373
Transfers out	(75,851)	(10,711)	(51,449)	—	(138,011)
Total other financing sources (uses)	<u>(72,091)</u>	<u>153,727</u>	<u>141,349</u>	<u>—</u>	<u>222,985</u>
Net change in fund balances	7,502	10,871	91,160	4	109,537
Fund balances at beginning of year	5,483	52,610	190,218	372	248,683
Fund balances at end of year	<u>\$ 12,985</u>	<u>\$ 63,481</u>	<u>\$ 281,378</u>	<u>\$ 376</u>	<u>\$ 358,220</u>

The accompanying notes are an integral part of the financial statements.

## General Fund

The General Fund is used to account for all financial resources of the City of Indianapolis except those required to be accounted for in another fund. Thus, all general operating revenues that are not restricted as to use by sources outside of the City are recorded in the General Fund. Further, as required by statute, the financial resources of the General Fund are accounted for in a series of subfunds as follows:

<b>Consolidated County -</b>	to account for all financial resources for which the taxpayer base is county-wide
<b>Redevelopment -</b>	to account for all financial resources of the Redevelopment special taxing district for economic development activities
<b>Solid Waste Collection -</b>	to account for all financial resources of the Solid Waste Collection special service district for refuse collection services
<b>Solid Waste Disposal -</b>	to account for all financial resources of the Solid Waste Disposal special service district for refuse disposal services
<b>Public Safety Communications -</b>	to account for all financial resources of the Public Safety Communication division of the Office of Public Health and Safety
<b>Transportation -</b>	to account for all financial resources of the Metropolitan Thoroughfare special taxing district
<b>Fire -</b>	to account for all financial resources of the Fire special service district
<b>Park -</b>	to account for all financial resources of the Park special taxing district
<b>Metropolitan Police -</b>	to account for all financial resources of the consolidated Indianapolis Metropolitan Police Department
<b>Storm Water Management -</b>	to account for all financial resources for storm water drainage services

**CITY OF INDIANAPOLIS**  
**(A Component Unit of the Consolidated City of Indianapolis - Marion County)**  
**Schedule of Subfund Assets, Liabilities, and Fund Balance – General Fund**  
December 31, 2022  
*(In thousands)*

	General Fund	Intrafund	Consolidated	Redevelop-	Solid Waste		Public Safety
	Total	Eliminations	County	ment	Collection	Disposal	Communications
<b>ASSETS</b>							
Equity in pooled cash	\$ 19,608	\$ —	\$ 9,479	\$ 983	\$ 637	\$ 9	\$ 200
Cash and investments with fiscal agents	4,555	—	—	—	4,555	—	—
Investments	331,331	—	201,657	12,586	8,146	118	2,566
Property taxes receivable	7,316	—	973	19	1,089	—	—
Accounts receivable	34,911	—	6,195	280	1,228	668	1
Allowance for estimated uncollectibles – accounts receivable	(1,520)	—	—	—	—	—	—
Due from other funds	14,775	—	14,775	—	—	—	—
Due from federal and state governments	5	—	—	4	—	—	—
Lease receivable	546	—	—	—	546	—	—
Long-term receivables	100	—	—	100	—	—	—
<b>Total assets</b>	<b>\$ 411,627</b>	<b>—</b>	<b>\$ 233,079</b>	<b>\$ 13,972</b>	<b>\$ 16,201</b>	<b>\$ 795</b>	<b>\$ 2,767</b>
<b>LIABILITIES, DEFERRED INFLOWS OF RESOURCES AND FUND BALANCES</b>							
Liabilities:							
Accounts payable and other accrued liabilities	\$ 50,951	\$ —	\$ 19,265	\$ 386	\$ 7,685	\$ 3,056	\$ 6
Accrued payroll and payroll taxes	16,838	—	6,482	46	206	—	—
Unearned revenue	296	—	—	—	—	—	—
<b>Total liabilities</b>	<b>68,085</b>	<b>—</b>	<b>25,747</b>	<b>432</b>	<b>7,891</b>	<b>3,056</b>	<b>6</b>
<b>Deferred inflows of resources</b>	<b>15,733</b>	<b>—</b>	<b>1,623</b>	<b>33</b>	<b>2,308</b>	<b>642</b>	<b>—</b>
Fund balances:							
<i>unallocated (hide me)</i>	—	—	—	—	—	—	—
Nonspendable	—	—	—	—	—	—	—
Restricted	91,746	—	—	—	—	—	—
Committed	12,273	—	12,273	—	—	—	—
Assigned	105,202	—	71,264	13,507	6,002	—	2,761
Unassigned	118,588	—	122,172	—	—	(2,903)	—
<b>Total fund balances</b>	<b>327,809</b>	<b>—</b>	<b>205,709</b>	<b>13,507</b>	<b>6,002</b>	<b>(2,903)</b>	<b>2,761</b>
<b>Total liabilities, deferred inflows of resources and fund balances</b>	<b>\$ 411,627</b>	<b>\$ —</b>	<b>\$ 233,079</b>	<b>\$ 13,972</b>	<b>\$ 16,201</b>	<b>\$ 795</b>	<b>\$ 2,767</b>

(Continued)

**CITY OF INDIANAPOLIS**  
**(A Component Unit of the Consolidated City of Indianapolis - Marion County)**  
**Schedule of Subfund Assets, Liabilities, and Fund Balance – General Fund**  
December 31, 2022  
*(In thousands)*

	<b>Transportation</b>	<b>Fire</b>	<b>Park</b>	<b>Metropolitan Police</b>	<b>Storm Water Management</b>
<b>ASSETS</b>					
Equity in pooled cash	\$ 3,246	\$ 474	\$ 687	\$ 897	\$ 2,996
Cash and investments with fiscal agents	—	—	—	—	—
Investments	41,560	6,061	8,793	11,487	38,357
Property taxes receivable	—	3,233	615	1,387	—
Accounts receivable	16,471	1,805	716	3,159	4,388
Allowance for estimated uncollectibles – accounts receivable	—	—	—	—	(1,520)
Due from other funds	—	—	—	—	—
Due from federal and state governments	—	—	—	1	—
Lease receivable	—	—	—	—	—
Long-term receivables	—	—	—	—	—
Total assets	\$ 61,277	\$ 11,573	\$ 10,811	\$ 16,931	\$ 44,221
<b>LIABILITIES, DEFERRED INFLOWS OF RESOURCES AND FUND BALANCES</b>					
Liabilities:					
Accounts payable and other accrued liabilities	\$ 7,047	\$ 2,755	\$ 2,511	\$ 5,162	\$ 3,078
Accrued payroll and payroll taxes	540	4,593	445	4,355	171
Unearned revenue	—	—	296	—	—
Total liabilities	7,587	7,348	3,252	9,517	3,249
<b>Deferred inflows of resources</b>	287	4,906	984	2,321	2,629
Fund balance:					
<i>unallocated (hide me)</i>	—	—	—	—	—
Nonspendable	—	—	—	—	—
Restricted	53,403	—	—	—	38,343
Committed	—	—	—	—	—
Assigned	—	—	6,575	5,093	—
Unassigned	—	(681)	—	—	—
Total fund balances	53,403	(681)	6,575	5,093	38,343
Total liabilities, deferred inflows of resources and fund balances	\$ 61,277	\$ 11,573	\$ 10,811	\$ 16,931	\$ 44,221

The accompanying notes are an integral part of the financial statements.

**CITY OF INDIANAPOLIS**  
**(A Component Unit of the Consolidated City of Indianapolis - Marion County)**  
**Schedule of Subfund Revenues, Expenditures, and Changes in Fund Balance – General Fund**  
Year ended December 31, 2022  
*(In thousands)*

	General Fund	Intrafund	Consolidated	Redevelop-	Solid Waste		Public Safety
	Total	eliminations	County	ment	Collection	Disposal	Communications
Revenues:							
Taxes	\$ 479,181	\$ —	\$ 238,918	\$ 1,649	\$ 40,253	\$ —	\$ —
Licenses and permits	17,770	—	16,404	125	—	—	—
Charges for services	80,998	—	12,697	1,130	2,567	8,877	—
Other intergovernmental revenues:							
Federal revenues	3,752	—	142	—	25	—	—
State revenues	134,892	—	3,024	750	—	—	—
Other revenues	6,457	—	3,923	—	—	—	—
Intragovernmental revenue	8,047	—	2,985	—	—	—	—
Traffic violations and court fees	2,030	—	1,310	—	—	—	—
Interest and other operating revenues	19,227	—	6,431	566	80	6	35
Total revenues	<u>752,354</u>	<u>—</u>	<u>285,834</u>	<u>4,220</u>	<u>42,925</u>	<u>8,883</u>	<u>35</u>
Expenditures:							
Current:							
General government	103,584	—	103,584	—	—	—	—
Public safety	516,388	—	31,557	306	—	—	1,237
Public works	125,219	—	(6)	—	37,507	10,726	—
Health and welfare	3,221	—	2,658	563	—	—	—
Cultural and recreation	28,032	—	1,100	—	—	—	—
Urban redevelopment and housing	6,449	—	4,764	1,685	—	—	—
Economic development and assistance	2,061	—	1,021	1,040	—	—	—
Debt service:							
Redemption of bonds, notes and financed purchase obligations	1,704	—	984	6	80	—	—
Interest on bonds and notes	282	—	199	1	—	—	—
Bond and note issuance costs	1,548	—	—	—	—	—	—
Lease payments and other	4,208	—	1,038	81	2,614	—	—
Capital outlays	73,260	—	1,525	187	368	—	312
Total expenditures	<u>865,956</u>	<u>—</u>	<u>148,424</u>	<u>3,869</u>	<u>40,569</u>	<u>10,726</u>	<u>1,549</u>
Excess (deficiency) of revenues over (under) expenditures	<u>(113,602)</u>	<u>—</u>	<u>137,410</u>	<u>351</u>	<u>2,356</u>	<u>(1,843)</u>	<u>(1,514)</u>
Other financing sources (uses):							
Issuance of lease liabilities	8,346	—	—	—	4,555	—	—
Sales of capital assets	1,495	—	232	911	—	—	—
Transfers in	72,677	(192,507)	218	333	—	350	—
Transfers out	(63,653)	192,507	(231,012)	(1,630)	(350)	—	—
Total other financing sources (uses)	<u>18,865</u>	<u>—</u>	<u>(230,562)</u>	<u>(386)</u>	<u>4,205</u>	<u>350</u>	<u>—</u>
Net change in fund balance	(94,737)	—	(93,152)	(35)	6,561	(1,493)	(1,514)
Fund balances (deficits) at beginning of year	422,546	—	298,861	13,542	(559)	(1,410)	4,275
Fund balances (deficits) at end of year	<u>\$ 327,809</u>	<u>\$ —</u>	<u>\$ 205,709</u>	<u>\$ 13,507</u>	<u>\$ 6,002</u>	<u>\$ (2,903)</u>	<u>\$ 2,761</u>

(Continued)



**CITY OF INDIANAPOLIS**  
**(A Component Unit of the Consolidated City of Indianapolis - Marion County)**  
**Schedule of Subfund Revenues, Expenditures, and Changes in Fund Balance – General Fund**  
Year ended December 31, 2022  
*(In thousands)*

	<u>Transportation</u>	<u>Fire</u>	<u>Park</u>	<u>Metropolitan Police</u>	<u>Storm Water Management</u>
Revenues:					
Taxes	\$ 15,623	\$ 103,898	\$ 25,888	\$ 52,952	\$ —
Licenses and permits	6	21	—	1,214	—
Charges for services	1,903	847	4,499	4,054	44,424
Other intergovernmental revenues:					
Federal revenues	1,711	—	32	1,842	—
State revenues	73,352	28,056	—	29,710	—
Other revenues	—	1,267	—	1,267	—
Intragovernmental revenue	835	3,247	—	1	979
Traffic violations and court fees	7	47	—	666	—
Interest and other operating revenues	2,329	3,315	87	5,648	730
Total revenues	<u>95,766</u>	<u>140,698</u>	<u>30,506</u>	<u>97,354</u>	<u>46,133</u>
Expenditures:					
Current:					
General government	—	—	—	—	—
Public safety	—	205,944	1,672	275,672	—
Public works	54,002	—	—	—	22,990
Health and welfare	—	—	—	—	—
Cultural and recreation	—	—	26,932	—	—
Urban redevelopment and housing	—	—	—	—	—
Economic development and assistance	—	—	—	—	—
Debt service:					
Redemption of bonds, notes and financed purchase obligations	150	130	131	143	80
Interest on bonds and notes	—	26	27	29	—
Bond and note issuance costs	—	—	—	1,548	—
Lease payments and other	1	72	11	2	389
Capital outlays	49,042	77	2,621	4,326	14,802
Total expenditures	<u>103,195</u>	<u>206,249</u>	<u>31,394</u>	<u>281,720</u>	<u>38,261</u>
Excess (deficiency) of revenues over (under) expenditures	<u>(7,429)</u>	<u>(65,551)</u>	<u>(888)</u>	<u>(184,366)</u>	<u>7,872</u>
Other financing sources (uses):					
Issuance of lease liabilities	—	—	—	3,791	—
Sales of capital assets	—	75	—	277	—
Transfers in	14,145	66,209	1,000	182,114	815
Transfers out	(12,935)	—	—	—	(10,233)
Total other financing sources (uses)	<u>1,210</u>	<u>66,284</u>	<u>1,000</u>	<u>186,182</u>	<u>(9,418)</u>
Net change in fund balance	(6,219)	733	112	1,816	(1,546)
Fund balances at beginning of year	59,622	(1,414)	6,463	3,277	39,889
Fund balances at end of year	<u>\$ 53,403</u>	<u>\$ (681)</u>	<u>\$ 6,575</u>	<u>\$ 5,093</u>	<u>\$ 38,343</u>

The accompanying notes are an integral part of the financial statements.

**CITY OF INDIANAPOLIS**  
**(A Component Unit of the Consolidated City of Indianapolis - Marion County)**  
**General Fund**  
**Schedule of Subfund Revenues, Expenditures, and Changes in Fund Balance**  
**Budget and Actual – Budgetary Basis**  
Year ended December 31, 2022  
*(In thousands)*

	<u>Total General Fund</u>		<u>Consolidated County</u>		<u>Redevelopment</u>		<u>Solid Waste Collection</u>	
	<u>Final budget</u>	<u>Actual</u>	<u>Final budget</u>	<u>Actual</u>	<u>Final budget</u>	<u>Actual</u>	<u>Final budget</u>	<u>Actual</u>
Revenues:								
Taxes	\$ 472,543	\$ 479,266	\$ 237,928	\$ 238,918	\$ 1,612	\$ 1,649	\$ 38,892	\$ 40,252
Licenses and permits	16,012	17,549	15,952	16,188	—	118	—	—
Charges for services	82,148	78,098	14,065	10,886	1,070	1,297	2,366	2,008
Other intergovernmental revenues:								
Federal revenues	1,211	4,365	—	2,402	—	—	—	25
State revenues	81,193	79,321	3,127	2,782	750	750	—	—
Other revenues	4,708	5,093	2,864	2,775	—	—	—	—
Traffic violations and court fees	2,382	2,444	1,807	1,817	—	—	—	—
Intragovernmental revenues	13,698	6,321	2,993	2,290	—	—	—	—
Interest and other operating revenues	19,109	17,661	5,096	5,370	250	541	241	76
Total revenues	<u>693,004</u>	<u>690,118</u>	<u>283,832</u>	<u>283,428</u>	<u>3,682</u>	<u>4,355</u>	<u>41,499</u>	<u>42,361</u>
Expenditures:								
Current:								
General government	30,460	30,387	30,460	30,387	—	—	—	—
Public safety	465,667	464,550	34,344	34,984	421	307	—	—
Public works	130,302	125,327	533	854	—	—	38,940	38,858
Health and welfare	876	3,623	300	2,912	576	711	—	—
Cultural and recreation	29,324	27,613	1,100	1,100	—	—	—	—
Urban redevelopment and housing	11,098	6,278	8,860	4,581	2,238	1,697	—	—
Economic development and assistance	1,174	2,669	—	1,023	1,174	1,646	—	—
Capital outlays	74,551	72,370	1,984	1,234	1,755	1,686	3,109	3,109
Total expenditures	<u>743,452</u>	<u>732,817</u>	<u>77,581</u>	<u>77,075</u>	<u>6,164</u>	<u>6,047</u>	<u>42,049</u>	<u>41,967</u>
Excess (deficiency) of revenues over (under) expenditures	<u>(50,448)</u>	<u>(42,699)</u>	<u>206,251</u>	<u>206,353</u>	<u>(2,482)</u>	<u>(1,692)</u>	<u>(550)</u>	<u>394</u>
Other financing sources (uses):								
Sales of capital assets	1,849	1,155	22	93	1,701	726	—	—
Transfers in (out)	3,629	10,084	(238,052)	(229,734)	(893)	(1,297)	—	(350)
Total other financing sources (uses)	<u>5,478</u>	<u>11,239</u>	<u>(238,030)</u>	<u>(229,641)</u>	<u>808</u>	<u>(571)</u>	<u>—</u>	<u>(350)</u>
Revenues over (under) expenditures and other financing sources (uses)	<u>(44,970)</u>	<u>(31,460)</u>	<u>(31,779)</u>	<u>(23,288)</u>	<u>(1,674)</u>	<u>(2,263)</u>	<u>(550)</u>	<u>44</u>
Fund balances at beginning of year	232,029	263,117	160,796	185,292	11,916	12,225	4,946	7,040
Cancellation of purchase orders and other	41,637	17,516	27,098	4,285	(1,593)	485	1,967	613
Fund balances at end of year	<u>\$ 228,696</u>	<u>\$ 249,173</u>	<u>\$ 156,115</u>	<u>\$ 166,289</u>	<u>\$ 8,649</u>	<u>\$ 10,447</u>	<u>\$ 6,363</u>	<u>\$ 7,697</u>

(Continued)

**CITY OF INDIANAPOLIS**  
**(A Component Unit of the Consolidated City of Indianapolis - Marion County)**  
**General Fund**  
**Schedule of Subfund Revenues, Expenditures, and Changes in Fund Balance**  
**Budget and Actual – Budgetary Basis**  
Year ended December 31, 2022  
*(In thousands)*

	Solid Waste Disposal		Public Safety Communications		Transportation		Metropolitan Police	
	Final budget	Actual	Final budget	Actual	Final budget	Actual	Final budget	Actual
Revenues:								
Taxes	\$ —	\$ —	\$ —	\$ —	\$ 17,513	\$ 15,708	\$ 51,044	\$ 52,952
Licenses and permits	—	—	—	—	—	6	40	1,214
Charges for services	9,189	8,851	—	—	1,811	1,851	3,099	3,651
Other intergovernmental revenues:								
Federal revenues	—	—	—	—	1,000	1,686	111	220
State revenues	—	—	—	—	74,298	73,292	2,475	1,939
Other revenues	—	—	—	—	—	—	922	1,159
Traffic violations and court fees	—	—	—	—	—	—	575	598
Intragovernmental revenues	—	—	—	—	6,672	2	—	1
Interest and other operating revenues	—	6	—	34	2,110	1,883	6,967	5,642
Total revenues	9,189	8,857	—	34	103,404	94,428	65,233	67,376
Expenditures:								
Current:								
General government	—	—	—	—	—	—	—	—
Public safety	—	—	—	—	—	—	251,732	248,826
Public works	8,725	8,713	—	—	57,737	53,367	—	—
Health and welfare	—	—	—	—	—	—	—	—
Cultural and recreation	—	—	—	—	—	—	—	—
Urban redevelopment and housing	—	—	—	—	—	—	—	—
Economic development and assistance	—	—	—	—	—	—	—	—
Capital outlays	180	180	—	—	50,648	49,836	1,545	1,211
Total expenditures	8,905	8,893	—	—	108,385	103,203	253,277	250,037
Excess (deficiency) of revenues over (under) expenditures	284	(36)	—	34	(4,981)	(8,775)	(188,044)	(182,661)
Other financing sources (uses):								
Sale of capital assets	—	—	—	—	—	—	126	264
Transfers in (out)	—	350	—	—	1,213	1,211	182,873	182,114
Total other financing sources (uses)	—	350	—	—	1,213	1,211	182,999	182,378
Revenues over (under) expenditures and other financing sources (uses)	284	314	—	34	(3,768)	(7,564)	(5,045)	(283)
Fund balances at beginning of year	(231)	(531)	856	2,519	\$ 17,064	17,918	4,830	3,716
Cancellation of purchase orders and other	70	25	1,717	89	1,447	8,011	5,014	1,266
Fund balances at end of year	\$ 123	\$ (192)	\$ 2,573	\$ 2,642	\$ 14,743	\$ 18,365	\$ 4,799	\$ 4,699

(Continued)

**CITY OF INDIANAPOLIS**  
**(A Component Unit of the Consolidated City of Indianapolis - Marion County)**  
**General Fund**  
**Schedule of Subfund Revenues, Expenditures, and Changes in Fund Balance**  
**Budget and Actual – Budgetary Basis**  
Year ended December 31, 2022  
*(In thousands)*

	Fire		Park		Storm Water Management	
	Final budget	Actual	Final budget	Actual	Final budget	Actual
Revenues:						
Taxes	\$ 100,357	\$ 103,899	\$ 25,197	\$ 25,888	\$ —	\$ —
Licenses and permits	20	23	—	—	—	—
Charges for services	1,229	830	4,679	4,336	44,640	44,388
Other intergovernmental revenues:						
Federal revenues	—	—	100	32	—	—
State revenues	543	558	—	—	—	—
Other revenues	922	1,159	—	—	—	—
Traffic violations and court fees	—	29	—	—	—	—
Intragovernmental revenues	3,247	3,247	—	—	786	781
Interest and other operating revenues	3,610	3,308	177	77	658	724
Total revenues	<u>109,928</u>	<u>113,053</u>	<u>30,153</u>	<u>30,333</u>	<u>46,084</u>	<u>45,893</u>
Expenditures:						
Current:						
General government	—	—	—	—	—	—
Public safety	178,803	178,738	367	1,695	—	—
Public works	—	—	—	—	24,367	23,535
Health and welfare	—	—	—	—	—	—
Cultural and recreation	—	—	28,224	26,513	—	—
Urban redevelopment and housing	—	—	—	—	—	—
Economic development and assistance	—	—	—	—	—	—
Capital outlays	—	—	3,929	3,717	11,401	11,397
Total expenditures	<u>178,803</u>	<u>178,738</u>	<u>32,520</u>	<u>31,925</u>	<u>35,768</u>	<u>34,932</u>
Excess (deficiency) of revenues over (under) expenditures	<u>(68,875)</u>	<u>(65,685)</u>	<u>(2,367)</u>	<u>(1,592)</u>	<u>10,316</u>	<u>10,961</u>
Other financing sources (uses):						
Sale of capital assets	—	72	—	—	—	—
Transfers in (out)	68,739	66,209	1,000	1,000	(11,251)	(9,419)
Total other financing sources (uses)	<u>68,739</u>	<u>66,281</u>	<u>1,000</u>	<u>1,000</u>	<u>(11,251)</u>	<u>(9,419)</u>
Revenues over (under) expenditures and other financing sources (uses)	(136)	596	(1,367)	(592)	(935)	1,542
Fund balances at beginning of year	3,249	2,643	1,786	3,416	26,817	28,879
Cancellation of purchase orders and other	96	276	974	405	4,847	2,061
Fund balances at end of year	<u>\$ 3,209</u>	<u>\$ 3,515</u>	<u>\$ 1,393</u>	<u>\$ 3,229</u>	<u>\$ 30,729</u>	<u>\$ 32,482</u>

The accompanying notes are an integral part of the financial statements.

**CITY OF INDIANAPOLIS**  
**(A Component Unit of the Consolidated City of Indianapolis - Marion County)**  
**General Fund**  
**Schedule of Expenditures by Character – Budget and Actual – Budgetary Basis**  
Year ended December 31, 2022  
*(In thousands)*

<u>Department and Division</u>	<u>Fund</u>	<u>Final budget</u>	<u>Actual</u>	<u>Variance</u>
Executive and Legislative				
Office of the Mayor	Consolidated County			
Personal services		\$ 3,297	\$ 3,231	\$ 66
Supplies		4	4	—
Other services and charges		3,639	3,629	10
Capital outlay		1	—	1
Internal charges		(949)	(949)	—
Total		<u>5,992</u>	<u>5,915</u>	<u>77</u>
Office of Audit and Performance	Consolidated County			
Personal services		839	818	21
Supplies		1	—	1
Other services and charges		912	910	2
Capital outlay		1	—	1
Internal charges		30	30	—
Total		<u>1,783</u>	<u>1,758</u>	<u>25</u>
City-County Council	Consolidated County			
Personal services		1,836	1,814	22
Supplies		6	2	4
Other services and charges		874	754	120
Capital outlay		3	1	2
Internal charges		7	7	—
Total		<u>2,726</u>	<u>2,578</u>	<u>148</u>
Office of the Corporation Counsel	Consolidated County			
Personal services		3,399	3,399	—
Supplies		1	1	—
Other services and charges		2,512	2,510	2
Internal charges		(4,187)	(4,187)	—
Total		<u>1,725</u>	<u>1,723</u>	<u>2</u>

(Continued)

**CITY OF INDIANAPOLIS**  
**(A Component Unit of the Consolidated City of Indianapolis - Marion County)**  
**General Fund**  
**Schedule of Expenditures by Character – Budget and Actual – Budgetary Basis**  
Year ended December 31, 2022  
*(In thousands)*

Department and Division	Fund	Final budget	Actual	Variance
Office of Finance and Management	Consolidated County			
Personal services		\$ 5,099	\$ 5,087	\$ 12
Supplies		12	12	—
Other services and charges		4,365	4,328	37
Capital outlay		1,076	1,076	—
Internal charges		299	299	—
Total		<u>10,851</u>	<u>10,802</u>	<u>49</u>
Minority and Women Owned Business	Consolidated County			
Personal services		652	652	—
Supplies		2	2	—
Other services and charges		151	143	8
Capital outlay		1	—	1
Internal charges		44	44	—
Total		<u>850</u>	<u>841</u>	<u>9</u>
Total – Executive and Legislative		<u>\$ 23,927</u>	<u>\$ 23,617</u>	<u>\$ 310</u>
Department of Metropolitan Development	Consolidated County			
Personal services		\$ 3,107	\$ 3,032	\$ 75
Supplies		12	5	7
Other services and charges		5,903	5,340	563
Capital outlay		113	4	109
Internal charges		138	136	2
Total		<u>9,273</u>	<u>8,517</u>	<u>756</u>
Department of Metropolitan Development	Redevelopment			
Personal services		1,287	1,264	23
Supplies		3	1	2
Other services and charges		2,957	2,934	23
Capital outlay		1,755	1,686	69
Internal charges		162	162	—
Total		<u>6,164</u>	<u>6,047</u>	<u>117</u>
Total – Department of Metropolitan Development		<u>\$ 15,437</u>	<u>\$ 14,564</u>	<u>\$ 873</u>

(Continued)

**CITY OF INDIANAPOLIS**  
**(A Component Unit of the Consolidated City of Indianapolis - Marion County)**  
**General Fund**  
**Schedule of Expenditures by Character – Budget and Actual – Budgetary Basis**  
Year ended December 31, 2022  
*(In thousands)*

Department and Division	Fund	Final budget	Actual	Variance
Department of Business and Neighborhood Services	Consolidated County			
Personal services		\$ 15,025	\$ 15,025	\$ —
Supplies		548	547	1
Other services and charges		8,970	8,969	1
Capital outlay		52	32	20
Internal charges		2,562	1,875	687
Total – Department of Business and Neighborhood Services		<u>\$ 27,157</u>	<u>\$ 26,448</u>	<u>\$ 709</u>
Department of Public Works	Consolidated County			
Personal services		\$ 11,138	\$ 11,060	\$ 78
Supplies		17,964	17,949	15
Other services and charges		8,888	8,721	167
Capital outlay		670	57	613
Internal charges		(35,043)	(32,623)	(2,420)
Total		<u>3,617</u>	<u>5,164</u>	<u>(1,547)</u>
Department of Public Works	Transportation			
Personal services		26,981	26,301	680
Supplies		7,051	6,659	392
Other services and charges		15,748	12,619	3,129
Capital outlay		50,648	49,836	812
Internal charges		7,957	7,788	169
Total		<u>108,385</u>	<u>103,203</u>	<u>5,182</u>
Department of Public Works	Park			
Personal services		5,008	5,008	—
Supplies		195	189	6
Other services and charges		1,544	1,474	70
Capital outlay		80	79	1
Internal charges		(6,826)	(6,749)	(77)
Total		<u>1</u>	<u>1</u>	<u>—</u>
Department of Public Works	Solid Waste Collection			
Personal services		7,919	7,919	—
Supplies		81	80	1
Other services and charges		24,671	24,652	19
Capital outlay		3,109	3,109	—
Internal charges		6,269	6,207	62
Total		<u>42,049</u>	<u>41,967</u>	<u>82</u>
Department of Public Works	Solid Waste Disposal			
Other services and charges		8,725	8,713	12
Capital outlay		180	180	—
Total		<u>8,905</u>	<u>8,893</u>	<u>12</u>
Department of Public Works	Storm Water Management			
Personal services		6,895	6,848	47
Supplies		79	76	3
Other services and charges		14,926	14,200	726
Capital outlay		11,401	11,397	4
Internal charges		2,467	2,411	56
Total		<u>35,768</u>	<u>34,932</u>	<u>836</u>
Total – Department of Public Works		<u>\$ 198,725</u>	<u>\$ 194,160</u>	<u>\$ 4,565</u>

(Continued)

**CITY OF INDIANAPOLIS**  
**(A Component Unit of the Consolidated City of Indianapolis - Marion County)**  
**General Fund**  
**Schedule of Expenditures by Character – Budget and Actual – Budgetary Basis**  
Year ended December 31, 2022  
*(In thousands)*

<u>Department and Division</u>	<u>Fund</u>	<u>Final budget</u>	<u>Actual</u>	<u>Variance</u>
Office of Public Health and Safety	Consolidated County			
Personal services		\$ 2,053	\$ 2,053	\$ —
Supplies		18	18	—
Other services and charges		10,292	10,020	272
Capital outlay		70	64	6
Internal charges		74	74	—
Total – Office of Public Health and Safety		<u>\$ 12,507</u>	<u>\$ 12,229</u>	<u>\$ 278</u>
Indianapolis Fire Department	Fire			
Personal services		\$ 161,086	\$ 161,086	\$ —
Supplies		2,085	2,049	36
Other services and charges		9,741	9,712	29
Internal charges		5,891	5,891	—
Total – Indianapolis Fire Department		<u>\$ 178,803</u>	<u>\$ 178,738</u>	<u>\$ 65</u>
Indianapolis Metropolitan Police Department	Metropolitan Police			
Personal services		\$ 214,605	\$ 213,466	\$ 1,139
Supplies		1,696	878	818
Other services and charges		24,211	23,262	949
Capital outlay		1,545	1,211	334
Internal charges		11,220	11,220	—
Total – Indianapolis Metropolitan Police Department		<u>\$ 253,277</u>	<u>\$ 250,037</u>	<u>\$ 3,240</u>
Department of Parks and Recreation	Consolidated County			
Other services and charges		\$ 1,100	\$ 1,100	\$ —
Total		<u>1,100</u>	<u>1,100</u>	<u>—</u>
Department of Parks and Recreation	Park			
Personal services		12,422	12,380	42
Supplies		775	702	73
Other services and charges		7,146	7,123	23
Capital outlay		3,849	3,637	212
Internal charges		8,327	8,082	245
Total		<u>32,519</u>	<u>31,924</u>	<u>595</u>
Total – Department of Parks and Recreation		<u>\$ 33,619</u>	<u>\$ 33,024</u>	<u>\$ 595</u>
Total – General Fund – by Department and Division		<u>\$ 743,452</u>	<u>\$ 732,817</u>	<u>\$ 10,635</u>

The accompanying notes are an integral part of the financial statements.



## Nonmajor Special Revenue Funds

The Special Revenue Funds include funds that are restricted as to use by the State government and special purpose funds established by authority of the City-County Council.

<b>Parking -</b>	to account for revenue from the concession agreement for parking meters; these receipts are used for the repair of sidewalks, curbs, and streets
<b>Cable Franchise PEG Grants -</b>	to account for contributions from the two cable franchise agreements to provide for public purpose grants for the capital costs of Public, Educational, or Governmental (PEG) Access Facilities
<b>Federal Grants -</b>	to account for all grants received from the U.S. Departments of Housing and Urban Development, Justice, Transportation, Homeland Security, and other miscellaneous federal agencies
<b>State of Indiana Grants -</b>	to account for all grants received from the State of Indiana
<b>Public Safety Income Tax -</b>	to account for public safety income tax receipts
<b>Drug Free Community -</b>	to account for drug free community grants

**CITY OF INDIANAPOLIS**  
**(A Component Unit of the Consolidated City of Indianapolis - Marion County)**  
**Combining Balance Sheet – Nonmajor Special Revenue Funds**  
December 31, 2022  
*(In thousands)*

	<u>Parking</u>	<u>Federal Grants</u>	<u>State of Indiana Grants</u>	<u>Public Safety Income Tax</u>	<u>Drug Free Community</u>	<u>Total Nonmajor Special Revenue Funds</u>
<b>ASSETS</b>						
Equity in pooled cash	\$ 796	\$ —	\$ 751	\$ —	\$ 19	\$ 1,566
Investments	10,188	—	9,623	—	243	20,054
Accounts receivable	778	—	34	—	—	812
Due from federal and state governments	—	20,635	—	—	—	20,635
Long-term receivables, less allowance of \$24,340	—	4,901	20,402	—	—	25,303
Total assets	<u>\$ 11,762</u>	<u>\$ 25,536</u>	<u>\$ 30,810</u>	<u>\$ —</u>	<u>\$ 262</u>	<u>\$ 68,370</u>
<b>LIABILITIES, DEFERRED INFLOWS OF RESOURCES AND FUND BALANCES</b>						
Liabilities:						
Accounts payable and other accrued liabilities	\$ 353	\$ 9,161	\$ 42	\$ —	\$ 85	\$ 9,641
Accrued payroll and payroll taxes	15	94	—	—	—	109
Due to other funds	—	13,741	—	—	—	13,741
Unearned revenue	—	783	—	—	—	783
Total liabilities	<u>368</u>	<u>23,779</u>	<u>42</u>	<u>—</u>	<u>85</u>	<u>24,274</u>
<b>Deferred inflows of resources</b>	<u>—</u>	<u>10,709</u>	<u>20,402</u>	<u>—</u>	<u>—</u>	<u>31,111</u>
Fund balances:						
Restricted	11,394	—	10,366	—	177	21,937
Unassigned	—	(8,952)	—	—	—	(8,952)
Total fund balances	<u>11,394</u>	<u>(8,952)</u>	<u>10,366</u>	<u>—</u>	<u>177</u>	<u>12,985</u>
Total liabilities, deferred inflows of resources and fund balances	<u>\$ 11,762</u>	<u>\$ 25,536</u>	<u>\$ 30,810</u>	<u>\$ —</u>	<u>\$ 262</u>	<u>\$ 68,370</u>

The accompanying notes are an integral part of the financial statements.

**CITY OF INDIANAPOLIS**  
**(A Component Unit of the Consolidated City of Indianapolis - Marion County)**  
**Combining Statement of Revenues, Expenditures, and Changes in Fund Balances – Nonmajor Special Revenue Funds**  
Year ended December 31, 2022  
*(In thousands)*

	<u>Parking</u>	<u>Federal Grants</u>	<u>State of Indiana Grants</u>	<u>Public Safety Income Tax</u>	<u>Drug Free Community</u>	<u>Total Nonmajor Special Revenue Funds</u>
Revenues:						
Taxes	\$ —	\$ —	\$ —	\$ 71,525	\$ —	\$ 71,525
Charges for services	3,149	—	—	—	—	3,149
Other intergovernmental revenues:						
Federal revenues	—	45,384	—	—	—	45,384
State revenues	—	—	4,197	—	—	4,197
Other revenues	—	—	—	—	238	238
Traffic violations and court fees	970	1,595	2,010	—	—	4,575
Interest and other operating revenues	217	(173)	67	270	2	383
Total revenues	<u>4,336</u>	<u>46,806</u>	<u>6,274</u>	<u>71,795</u>	<u>240</u>	<u>129,451</u>
Expenditures:						
Current:						
General government	—	2,447	147	—	197	2,791
Public safety	—	9,662	757	—	—	10,419
Public works	899	341	—	—	—	1,240
Health and welfare	—	16,952	—	—	—	16,952
Cultural and recreation	—	789	—	—	—	789
Urban redevelopment and housing	—	13,076	—	—	—	13,076
Economic development and assistance	—	177	—	—	—	177
Debt service:						
Redemption of bonds, notes and financed purchase obligations	—	5	—	—	—	5
Bond and note issuance costs	—	84	—	—	—	84
Lease payments and other	—	161	—	—	—	161
Capital outlay	1,261	2,903	—	—	—	4,164
Total expenditures	<u>2,160</u>	<u>46,597</u>	<u>904</u>	<u>—</u>	<u>197</u>	<u>49,858</u>
Excess (deficiency) of revenues over (under) expenditures	<u>2,176</u>	<u>209</u>	<u>5,370</u>	<u>71,795</u>	<u>43</u>	<u>79,593</u>
Other financing sources (uses):						
Bonds, notes and financed purchase obligations issued	—	3,750	—	—	—	3,750
Transfers in	—	10	—	—	—	10
Transfers out	(400)	(3,656)	—	(71,795)	—	(75,851)
Total other financing sources (uses)	<u>(400)</u>	<u>104</u>	<u>—</u>	<u>(71,795)</u>	<u>—</u>	<u>(72,091)</u>
Net change in fund balances	1,776	313	5,370	—	43	7,502
Fund balances at beginning of year	9,618	(9,265)	4,996	—	134	5,483
Fund balances (deficits) at end of year	<u>\$ 11,394</u>	<u>\$ (8,952)</u>	<u>\$ 10,366</u>	<u>\$ —</u>	<u>\$ 177</u>	<u>\$ 12,985</u>

The accompanying notes are an integral part of the financial statements.

**CITY OF INDIANAPOLIS**  
**(A Component Unit of the Consolidated City of Indianapolis - Marion County)**  
**Special Revenue Funds**  
**Combining Schedule of Revenues, Expenditures, and Changes in Fund Balances**  
**Budget and Actual – Budgetary Basis**  
Year ended December 31, 2022  
*(In thousands)*

	Parking		Federal Grants		State of Indiana Grants		Public Safety Income Tax		Drug Free Community		Totals	
	Final budget	Actual	Final budget	Actual	Final budget	Actual	Final budget	Actual	Final budget	Actual	Final budget	Actual
Revenues:												
Taxes	\$ —	\$ —	\$ —	\$ —	\$ —	\$ —	\$ 71,594	\$ 71,525	\$ —	\$ —	\$ 71,594	\$ 71,525
Charges for services	3,800	2,582	—	—	—	—	—	—	—	—	3,800	2,582
Other intergovernmental revenues:												
Federal revenues	—	—	103,607	31,117	—	—	—	—	—	—	103,607	31,117
State revenues	—	—	—	—	—	4,197	—	—	—	—	—	4,197
Traffic violations and court fees	1,200	843	2,446	1,595	1,642	1,964	—	—	—	—	5,288	4,402
Interest and other operating revenues	—	188	—	57	—	67	—	270	—	2	—	584
Total revenues	5,000	3,613	106,053	32,769	1,642	6,228	71,594	71,795	—	2	184,289	114,407
Expenditures:												
Current:												
General government	41	—	6,615	1,249	—	—	—	—	190	190	6,846	1,439
Public safety	—	—	22,506	10,535	1,961	881	—	—	—	—	24,467	11,416
Public works	1,567	831	600	320	—	—	—	—	—	—	2,167	1,151
Health and welfare	—	—	17,316	12,568	—	—	—	—	—	—	17,316	12,568
Cultural and recreation	—	—	1,981	678	—	—	—	—	—	—	1,981	678
Urban redevelopment and housing	—	—	46,840	24,042	1,169	—	—	—	—	—	48,009	24,042
Economic development and assistance	—	—	9,975	391	—	—	—	—	—	—	9,975	391
Capital outlays	1,750	1,686	9,701	4,703	—	—	—	—	—	—	11,451	6,389
Total expenditures	3,358	2,517	115,534	54,486	3,130	881	—	—	190	190	122,212	58,074
Excess (deficiency) of revenues over (under) expenditures	1,642	1,096	(9,481)	(21,717)	(1,488)	5,347	71,594	71,795	(190)	(188)	62,077	56,333
Other financing sources (uses), net:												
Sale of capital assets	—	—	—	—	—	—	—	—	—	—	—	—
Transfers in (out)	(800)	(400)	(1,268)	(3,855)	(837)	(147)	(67,792)	(71,795)	300	238	(70,397)	(75,959)
Total other financing sources (uses)	(800)	(400)	(1,268)	(3,855)	(837)	(147)	(67,792)	(71,795)	300	238	(70,397)	(75,959)
Revenues over (under) expenditures and other financing sources (uses)	842	696	(10,749)	(25,572)	(2,325)	5,200	3,802	—	110	50	(8,320)	(19,626)
Fund balances (deficits) at beginning of year	6,770	5,571	—	—	—	—	—	—	(83)	49	6,687	5,620
Cancellation of purchase orders and other	(2,579)	389	10,749	25,572	2,325	(5,200)	(3,802)	—	126	—	6,819	20,761
Fund balances at end of year	\$ 5,033	\$ 6,656	\$ —	\$ —	\$ —	\$ —	\$ —	\$ —	\$ 153	\$ 99	\$ 5,186	\$ 6,755

**CITY OF INDIANAPOLIS**  
**(A Component Unit of the Consolidated City of Indianapolis - Marion County)**  
**Special Revenue Funds**  
**Schedule of Expenditures by Character – Budget and Actual – Budgetary Basis**  
Year ended December 31, 2022  
*(In thousands)*

<u>Department and Division</u>	<u>Fund</u>	<u>Final budget</u>	<u>Actual</u>	<u>Variance</u>
<b>Executive and Legislative</b>				
Mayor's Office	Federal Grants			
Other services and charges		\$ 40	\$ 32	\$ 8
Total		<u>40</u>	<u>32</u>	<u>8</u>
Office of Finance and Management	Parking			
Personal services		41	—	41
Total		<u>41</u>	<u>—</u>	<u>41</u>
Office of Finance and Management	Federal Grants			
Supplies		2,500	—	2,500
Other services and charges		2,775	1,217	1,558
Total		<u>5,275</u>	<u>1,217</u>	<u>4,058</u>
Office of Finance and Management	Drug Free Community			
Other services and charges		190	190	—
Total		<u>190</u>	<u>190</u>	<u>—</u>
Non-Departmental	Federal Grants			
Personal services		1,000	—	1,000
Supplies		100	—	100
Other services and charges		200	160	40
Total		<u>1,300</u>	<u>160</u>	<u>1,140</u>
Non-Departmental	Coronavirus Stimulus Fund			
Personal services		24,800	12,497	12,303
Supplies		1,300	13	1,287
Other services and charges		210,492	193,156	17,336
Capital outlay		—	29,996	(29,996)
Total		<u>236,592</u>	<u>235,662</u>	<u>930</u>
Total - Executive and Legislative		<u>\$ 243,438</u>	<u>\$ 237,261</u>	<u>\$ 6,177</u>
Department of Metropolitan Development	Federal Grants			
Personal services		\$ 1,534	\$ 1,095	\$ 439
Supplies		13	3	10
Other services and charges		72,314	35,633	36,681
Capital outlay		3,500	1,746	1,754
Internal charges		269	269	—
Total		<u>77,630</u>	<u>38,746</u>	<u>38,884</u>
Department of Metropolitan Development	State of Indiana Grants			
Other services and charges		1,169	—	1,169
Total		<u>1,169</u>	<u>—</u>	<u>1,169</u>
Total – Department of Metropolitan Development		<u>\$ 78,799</u>	<u>\$ 38,746</u>	<u>\$ 40,053</u>
Department of Public Works	Parking			
Personal services		\$ 567	\$ 567	\$ —
Other services and charges		1,000	264	736
Capital outlay		1,750	1,686	64
Total		<u>3,317</u>	<u>2,517</u>	<u>800</u>
Department of Public Works	Federal Grants			
Other services and charges		600	320	280
Capital outlay		2,500	785	1,715
Total		<u>3,100</u>	<u>1,105</u>	<u>1,995</u>
Total – Department of Public Works		<u>\$ 6,417</u>	<u>\$ 3,622</u>	<u>\$ 2,795</u>

(Continued)

**CITY OF INDIANAPOLIS**  
**(A Component Unit of the Consolidated City of Indianapolis - Marion County)**  
**Special Revenue Funds**  
**Schedule of Expenditures by Character – Budget and Actual – Budgetary Basis**  
Year ended December 31, 2022  
*(In thousands)*

<u>Department and Division</u>	<u>Fund</u>	<u>Final budget</u>	<u>Actual</u>	<u>Variance</u>
Office of Public Health and Safety	Federal Grants			
Personal services		\$ 100	\$ —	\$ 100
Supplies		138	—	138
Other services and charges		2,786	859	1,927
Capital outlay		100	20	80
Total		<u>3,124</u>	<u>879</u>	<u>2,245</u>
Office of Public Health and Safety	State of Indiana Grants			
Personal services		84	—	84
Supplies		75	—	75
Other services and charges		650	75	575
Total		<u>809</u>	<u>75</u>	<u>734</u>
Total – Office of Public Health and Safety		<u>\$ 3,933</u>	<u>\$ 954</u>	<u>\$ 2,979</u>
Indianapolis Fire Department	Federal Grants			
Personal services		\$ 6,239	\$ 3,022	\$ 3,217
Supplies		653	141	512
Other services and charges		4,022	2,791	1,231
Capital outlay		1,064	200	864
Internal charges		40	14	26
Total		<u>12,018</u>	<u>6,168</u>	<u>5,850</u>
Indianapolis Fire Department	State of Indiana Grants			
Supplies		173	—	173
Total		<u>173</u>	<u>—</u>	<u>173</u>
Total – Indianapolis Fire Department		<u>\$ 12,191</u>	<u>\$ 6,168</u>	<u>\$ 6,023</u>
Indianapolis Metropolitan Police Department	Federal Grants			
Personal services		\$ 4,292	\$ 1,318	\$ 2,974
Supplies		383	374	9
Other services and charges		3,854	1,858	1,996
Capital outlay		1,419	1,201	218
Total		<u>9,948</u>	<u>4,751</u>	<u>5,197</u>
Indianapolis Metropolitan Police Department	State of Indiana Grants			
Supplies		979	806	173
Total		<u>979</u>	<u>806</u>	<u>173</u>
Indianapolis Metropolitan Police Department	Coronavirus Stimulus Fund			
Other services and charges		—	52	(52)
Total		<u>—</u>	<u>52</u>	<u>(52)</u>
Total - Indianapolis Metropolitan Police Department		<u>\$ 10,927</u>	<u>\$ 5,609</u>	<u>\$ 5,318</u>
Department of Parks and Recreation	Federal Grants			
Personal services		\$ 358	\$ 109	\$ 249
Supplies		3	—	3
Other services and charges		1,620	569	1,051
Capital outlay		1,118	750	368
Internal charges		—	—	—
Total – Department of Parks and Recreation		<u>\$ 3,099</u>	<u>\$ 1,428</u>	<u>\$ 1,671</u>
Total – Special Revenue Funds – by Department and Division		<u>\$ 358,804</u>	<u>\$ 293,788</u>	<u>\$ 65,016</u>

The accompanying notes are an integral part of the financial statements.

## Nonmajor Debt Service Funds

Debt Service Funds are used to account for the accumulation of resources for, and the payment of, general long-term debt principal, interest, and related costs of four of the taxing districts. Nonmajor Debt service requirements are funded generally from property tax revenues and other operating revenues.

<b>Civil City -</b>	to account for the accumulation of resources for, and the payment of general long-term bonded debt principal, interest, and related costs of bond issues benefiting the taxpayers of the Civil City
<b>Public Safety Communications -</b>	to account for the accumulation of resources for, and the payment of, costs associated with the Public Safety Communications System Equipment
<b>Stormwater District -</b>	to account for the accumulation of resources for, and the payment of, general long-term bonded debt principal, interest, and related costs of bond issues benefiting the taxpayers of the Stormwater District
<b>Metropolitan Thoroughfare District -</b>	to account for the accumulation of resources for, and the payment of, general long-term bonded debt principal, interest, and related costs of bond issues benefiting the taxpayers of the Metropolitan Thoroughfare District
<b>Park District -</b>	to account for the accumulation of resources for, and the payment of, general long-term bonded debt principal, interest, and related costs of bond issues benefiting the taxpayers of the Park District
<b>Economic Development District -</b>	to account for accumulation of resources for, and payments of long term bonded debt principal, interest, and related costs of bond issues for certain economic development projects. In addition, this fund also includes the activity for the Circle Area Community Development Corporation (“CAC”), which is a blended component unit of the City
<b>PILOT -</b>	to account for accumulation of resources for, and payments of long-term debt principal, interest, and related costs of debt issued for certain projects for the Department of Public Works

**CITY OF INDIANAPOLIS**  
**(A Component Unit of the Consolidated City of Indianapolis - Marion County)**  
**Combining Balance Sheet – Nonmajor Debt Service Funds**  
December 31, 2022  
*(In thousands)*

	<b>Civil City</b>	<b>Public Safety Communications</b>	<b>Stormwater District</b>	<b>Metropolitan Thoroughfare District</b>	<b>Park District</b>	<b>Economic Development District</b>	<b>PILOT</b>	<b>Total Nonmajor Debt Service Funds</b>
<b>ASSETS</b>								
Equity in pooled cash	\$ 277	\$ 254	\$ —	\$ 175	\$ 138	\$ 769	\$ 3	\$ 1,616
Cash and investments with fiscal agents	—	57	—	22	—	37,986	10	38,075
Investments	3,544	3,258	—	2,254	1,761	9,844	33	20,694
Property taxes receivable	130	210	—	57	44	—	—	441
Accounts receivable	134	106	—	36	23	319	—	618
Long-term receivables	—	—	—	—	—	13,742	—	13,742
<b>Total assets</b>	<b>\$ 4,085</b>	<b>\$ 3,885</b>	<b>\$ —</b>	<b>\$ 2,544</b>	<b>\$ 1,966</b>	<b>\$ 62,660</b>	<b>\$ 46</b>	<b>\$ 75,186</b>
<b>LIABILITIES, DEFERRED INFLOWS OF RESOURCES AND FUND BALANCES</b>								
Matured bonds and notes payable	\$ 2,635	\$ 2,065	\$ —	\$ 1,540	\$ 1,015	\$ 387	\$ —	\$ 7,642
Matured interest payable	765	256	—	435	519	691	—	2,666
Accounts payable and other accrued liabilities	—	—	—	—	—	661	—	661
Unearned revenue	—	—	—	—	—	—	—	—
<b>Total liabilities</b>	<b>3,400</b>	<b>2,321</b>	<b>—</b>	<b>1,975</b>	<b>1,534</b>	<b>1,739</b>	<b>—</b>	<b>10,969</b>
<b>Deferred inflows of resources</b>	<b>262</b>	<b>315</b>	<b>—</b>	<b>94</b>	<b>65</b>	<b>—</b>	<b>—</b>	<b>736</b>
Fund balances:								
Restricted	423	1,249	—	475	367	60,921	46	63,481
<b>Total fund balances</b>	<b>423</b>	<b>1,249</b>	<b>—</b>	<b>475</b>	<b>367</b>	<b>60,921</b>	<b>46</b>	<b>63,481</b>
<b>Total liabilities, deferred inflows of resources and fund balances</b>	<b>\$ 4,085</b>	<b>\$ 3,885</b>	<b>\$ —</b>	<b>\$ 2,544</b>	<b>\$ 1,966</b>	<b>\$ 62,660</b>	<b>\$ 46</b>	<b>\$ 75,186</b>

The accompanying notes are an integral part of the financial statements.



**CITY OF INDIANAPOLIS**  
**(A Component Unit of the Consolidated City of Indianapolis - Marion County)**  
**Combining Statement of Revenues, Expenditures, and Changes in Fund Balances – Nonmajor Debt Service Funds**  
Year ended December 31, 2022  
*(In thousands)*

	<u>Civil City</u>	<u>Public Safety Communications</u>	<u>Stormwater District</u>	<u>Metropolitan Thoroughfare District</u>	<u>Park District</u>	<u>Economic Development District</u>	<u>PILOT</u>	<u>Total Nonmajor Debt Service Funds</u>
Revenues:								
Property taxes	\$ 3,233	\$ 6,950	\$ —	\$ 2,280	\$ 2,280	\$ 12,278	\$ —	\$ 27,021
Other taxes	307	583	—	192	192	—	—	1,274
Charges for services	—	—	—	—	—	—	—	—
Interest on investments	21	28	28	12	8	1,002	52	1,151
Other revenues	—	—	(8)	—	—	9,000	20,152	29,144
Total revenues	<u>3,561</u>	<u>7,561</u>	<u>20</u>	<u>2,484</u>	<u>2,480</u>	<u>22,280</u>	<u>20,204</u>	<u>58,590</u>
Debt service:								
Redemption of bonds, notes and financed purchase obligations	3,140	6,635	54,495	4,005	1,015	74,748	5,115	149,153
Interest on bonds and notes	1,614	1,061	5,846	5,534	1,152	18,590	6,969	40,766
Bond issuance costs	—	—	—	—	—	523	—	523
Lease payments and other	43	42	124	204	24	2,484	8,083	11,004
Total expenditures	<u>4,797</u>	<u>7,738</u>	<u>60,465</u>	<u>9,743</u>	<u>2,191</u>	<u>96,345</u>	<u>20,167</u>	<u>201,446</u>
Excess (deficiency) of revenues over (under) expenditures	<u>(1,236)</u>	<u>(177)</u>	<u>(60,445)</u>	<u>(7,259)</u>	<u>289</u>	<u>(74,065)</u>	<u>37</u>	<u>(142,856)</u>
Other financing sources (uses):								
Bonds, notes and financed purchase obligations issued	—	—	—	—	—	18,225	—	18,225
Refunding bonds issued	—	—	—	—	—	24,110	—	24,110
Transfers in	575	—	60,436	7,312	—	53,780	—	122,103
Transfers out	—	—	—	—	—	(10,711)	—	(10,711)
Total other financing sources (uses)	<u>575</u>	<u>—</u>	<u>60,436</u>	<u>7,312</u>	<u>—</u>	<u>85,404</u>	<u>—</u>	<u>153,727</u>
Net change in fund balances	<u>(661)</u>	<u>(177)</u>	<u>(9)</u>	<u>53</u>	<u>289</u>	<u>11,339</u>	<u>37</u>	<u>10,871</u>
Fund balances at beginning of year	1,084	1,426	9	422	78	49,582	9	52,610
Fund balances at end of year	<u>\$ 423</u>	<u>\$ 1,249</u>	<u>\$ —</u>	<u>\$ 475</u>	<u>\$ 367</u>	<u>\$ 60,921</u>	<u>\$ 46</u>	<u>\$ 63,481</u>

The accompanying notes are an integral part of the financial statements.

**CITY OF INDIANAPOLIS**  
**(A Component Unit of the Consolidated City of Indianapolis - Marion County)**  
**Debt Service Funds**  
**Combining Schedule of Revenues, Expenditures, and Changes in Fund Balances**  
**Budget and Actual – Budgetary Basis**  
Year ended December 31, 2022  
*(In thousands)*

	Civil City		Public Safety Communications		Stormwater District		Metropolitan Thoroughfare District		Revenue	
	Final budget	Actual	Final budget	Actual	Final budget	Actual	Final budget	Actual	Final budget	Actual
Revenues:										
Taxes	\$ 4,102	\$ 3,541	\$ 7,376	\$ 7,534	\$ —	\$ —	\$ 2,419	\$ 2,472	\$ 121,046	\$ 116,692
Charges for services	—	—	—	—	—	—	—	—	—	—
Other operating revenues	—	21	—	28	—	21	—	12	1,071	4,318
Total revenues	<u>4,102</u>	<u>3,562</u>	<u>7,376</u>	<u>7,562</u>	<u>—</u>	<u>21</u>	<u>2,419</u>	<u>2,484</u>	<u>122,117</u>	<u>121,010</u>
Expenditures:										
Economic development and assistance	—	—	—	—	—	—	—	—	8,000	8,000
Debt service	<u>4,805</u>	<u>4,797</u>	<u>7,738</u>	<u>7,738</u>	<u>61,964</u>	<u>60,465</u>	<u>9,743</u>	<u>9,743</u>	<u>79,820</u>	<u>59,378</u>
Total expenditures	<u>4,805</u>	<u>4,797</u>	<u>7,738</u>	<u>7,738</u>	<u>61,964</u>	<u>60,465</u>	<u>9,743</u>	<u>9,743</u>	<u>87,820</u>	<u>67,378</u>
Deficiency of revenues under expenditures	<u>(703)</u>	<u>(1,235)</u>	<u>(362)</u>	<u>(176)</u>	<u>(61,964)</u>	<u>(60,444)</u>	<u>(7,324)</u>	<u>(7,259)</u>	<u>34,297</u>	<u>53,632</u>
Other financing sources (uses), net:										
Bond proceeds	—	—	—	—	50,212	—	—	—	1,007	18,430
Transfers in (out)	<u>575</u>	<u>575</u>	<u>—</u>	<u>—</u>	<u>11,751</u>	<u>60,436</u>	<u>7,311</u>	<u>7,312</u>	<u>5,620</u>	<u>(35,767)</u>
Total other financing sources (uses)	<u>575</u>	<u>575</u>	<u>—</u>	<u>—</u>	<u>61,963</u>	<u>60,436</u>	<u>7,311</u>	<u>7,312</u>	<u>6,627</u>	<u>(17,337)</u>
Revenues over (under) expenditures and other financing sources (uses)	(128)	(660)	(362)	(176)	(1)	(8)	(13)	53	40,924	36,295
Fund balances at beginning of year	750	1,082	1,221	1,426	—	9	306	398	204	1,594
Cancellation of purchase orders and other	<u>(317)</u>	<u>(1)</u>	<u>179</u>	<u>(1)</u>	<u>4</u>	<u>(1)</u>	<u>69</u>	<u>1</u>	<u>(39,553)</u>	<u>(36,285)</u>
Fund balances at end of year	<u>\$ 305</u>	<u>\$ 421</u>	<u>\$ 1,038</u>	<u>\$ 1,249</u>	<u>\$ 3</u>	<u>\$ —</u>	<u>\$ 362</u>	<u>\$ 452</u>	<u>\$ 1,575</u>	<u>\$ 1,604</u>

(Continued)

**CITY OF INDIANAPOLIS**  
**(A Component Unit of the Consolidated City of Indianapolis - Marion County)**  
**Debt Service Funds**  
**Combining Schedule of Revenues, Expenditures, and Changes in Fund Balances**  
**Budget and Actual – Budgetary Basis**  
Year ended December 31, 2022  
*(In thousands)*

	Park District		Economic Development District		PILOT		Totals	
	Final budget	Actual	Final budget	Actual	Final budget	Actual	Final budget	Actual
Revenues:								
Taxes	\$ 2,269	\$ 2,472	\$ 12,814	\$ 12,278	\$ —	\$ —	\$ 150,026	\$ 144,989
Charges for services	—	—	1,598	2,331	—	—	1,598	2,331
Other operating revenues	—	8	—	4,851	20,152	20,203	21,223	29,462
Total revenues	<u>2,269</u>	<u>2,480</u>	<u>14,412</u>	<u>19,460</u>	<u>20,152</u>	<u>20,203</u>	<u>172,847</u>	<u>176,782</u>
Expenditures:								
Economic development and assistance	—	—	—	—	—	—	8,000	8,000
Debt service	<u>2,198</u>	<u>2,192</u>	<u>110,363</u>	<u>93,948</u>	<u>12,085</u>	<u>12,085</u>	<u>288,716</u>	<u>250,346</u>
Total expenditures	<u>2,198</u>	<u>2,192</u>	<u>110,363</u>	<u>93,948</u>	<u>12,085</u>	<u>12,085</u>	<u>296,716</u>	<u>258,346</u>
Deficiency of revenues under expenditures	<u>71</u>	<u>288</u>	<u>(95,951)</u>	<u>(74,488)</u>	<u>8,067</u>	<u>8,118</u>	<u>(123,869)</u>	<u>(81,564)</u>
Other financing sources (uses), net:								
Bond proceeds	—	—	44,018	42,335	—	—	95,237	60,765
Transfers in (out)	—	—	—	42,589	(8,081)	(8,082)	17,176	67,063
Total other financing sources (uses)	<u>—</u>	<u>—</u>	<u>44,018</u>	<u>84,924</u>	<u>(8,081)</u>	<u>(8,082)</u>	<u>112,413</u>	<u>127,828</u>
Revenues over (under) expenditures and other financing sources (uses)	71	288	(51,933)	10,436	(14)	36	(11,456)	46,264
Fund balances at beginning of year	59	77	998	577	14	10	3,552	5,173
Cancellation of purchase orders and other	<u>165</u>	<u>—</u>	<u>51,337</u>	<u>(10,436)</u>	<u>—</u>	<u>(1)</u>	<u>11,884</u>	<u>(46,724)</u>
Fund balances at end of year	<u>\$ 295</u>	<u>\$ 365</u>	<u>\$ 402</u>	<u>\$ 577</u>	<u>\$ —</u>	<u>\$ 45</u>	<u>\$ 3,980</u>	<u>\$ 4,713</u>

The accompanying notes are an integral part of the financial statements.

**CITY OF INDIANAPOLIS**  
**(A Component Unit of the Consolidated City of Indianapolis - Marion County)**  
**Debt Service Funds**  
**Schedule of Expenditures by Character – Budget and Actual – Budgetary Basis**  
Year ended December 31, 2022  
*(In thousands)*

<u>Department</u>	<u>Fund</u>	<u>Final budget</u>	<u>Actual</u>	<u>Variance</u>
Department of Metropolitan Development	Revenue			
Other services and charges		\$ 1,070	\$ 743	\$ 327
Total		<u>1,070</u>	<u>743</u>	<u>327</u>
Non Departmental	Stormwater District			
Other services and charges		61,964	60,465	1,499
Total		<u>61,964</u>	<u>60,465</u>	<u>1,499</u>
Non Departmental	Metropolitan Thoroughfare District			
Other services and charges		9,743	9,743	—
Total		<u>9,743</u>	<u>9,743</u>	<u>—</u>
Non Departmental	Park District			
Other services and charges		2,198	2,192	6
Total		<u>2,198</u>	<u>2,192</u>	<u>6</u>
Non Departmental	Public Safety Communications			
Other services and charges		7,738	7,738	—
Total		<u>7,738</u>	<u>7,738</u>	<u>—</u>
Non Departmental	Civil City			
Other services and charges		4,805	4,797	8
Total		<u>4,805</u>	<u>4,797</u>	<u>8</u>
Non Departmental	Revenue			
Other services and charges		86,750	66,635	20,115
Total		<u>86,750</u>	<u>66,635</u>	<u>20,115</u>
Non Departmental	Economic Development			
Other services and charges		110,363	93,948	16,415
Total		<u>110,363</u>	<u>93,948</u>	<u>16,415</u>
Non Departmental	PILOT			
Other services and charges		12,085	12,085	—
Total		<u>12,085</u>	<u>12,085</u>	<u>—</u>
Total – Debt Service Funds – by Department		<u>\$ 296,716</u>	<u>\$ 258,346</u>	<u>\$ 38,370</u>

The accompanying notes are an integral part of the financial statements.

## Nonmajor Capital Project Funds

The Capital Project Funds are used to account for resources designated to construct or acquire general capital assets. Such resources are derived principally from special district bonds, federal grants, and property tax levies.

<b>Economic Development -</b>	to account for all financial resources relating to projects funded through economic development bonds of the City
<b>PILOT Revenue Bonds -</b>	to account for all financial resources accumulated and payments made for construction, renovation, rehabilitation, and installation, of certain improvements to the City's public roads, street and sidewalks, and other public facilities
<b>Metropolitan Thoroughfare District -</b>	to account for all financial resources related to projects constructed wholly or in part from Metropolitan Thoroughfare District bond issue proceeds (except tax increment bonds) and any participating federal and state grants, including any required City local matching funds
<b>Park District -</b>	to account for all financial resources related to projects constructed from proceeds of the Park District bond issues
<b>City Cumulative Capital Improvement -</b>	to account for all resources accumulating from a City-wide ad valorem property tax levy to provide for the cost of construction, maintenance, acquisition, and repair of certain facilities and other items of a capital nature
<b>County Cumulative Capital Improvement -</b>	to account for all resources accumulating from a County-wide ad valorem property tax levy to provide for the cost of construction, maintenance, acquisition, and repair of certain facilities and other items of a capital nature
<b>Tax Revenue Note -</b>	to account for all financial resources related to purchases of certain vehicles and other equipment from the proceeds of a tax revenue note
<b>Public Safety Communications -</b>	to account for all financial resources related to acquisition of computer hardware and software from proceeds of the Public Safety Communication System and Computer Facilities District bonds
<b>Landmark Building Preservation -</b>	to account for all financial resources related to costs of major repairs to certain City properties
<b>Fire Cumulative -</b>	to account for all resources for the fire department accumulating from an ad valorem property tax levy to provide for the cost of construction, maintenance, acquisition, and repair of certain facilities and other items of a capital nature
<b>Storm Water -</b>	to account for all financial resources related to expenditures for construction of storm water removal infrastructure

**Capital Asset Development & Lifecycle -**

to account for revenues from operating agreements with outside contractors which are to be used to purchase capital assets for the benefit of the City

**Consolidated City District -**

to account for all financial resources to acquire or construct various equipment and other assets benefiting the Civil City District

**Section 108 HUD Loan -**

to account for financial resources from the HUD Section 108 loan program, Community & Economic Development Loan Program (“CEDLP”)

**CITY OF INDIANAPOLIS**  
**(A Component Unit of the Consolidated City of Indianapolis - Marion County)**  
**Combining Balance Sheet – Nonmajor Capital Projects Funds**  
December 31, 2022  
*(In thousands)*

		<b>Economic Development</b>		<b>PILOT Revenue Bonds</b>		<b>Metropolitan Thoroughfare District</b>		<b>Park District</b>		<b>City Cumulative Capital Improvement</b>
<b>ASSETS</b>										
Equity in pooled cash	\$	—	\$	7	\$	—	\$	—	\$	1,170
Cash and investments with fiscal agents		3,589		—		8,048		—		10,274
Investments		—		86		27,431		20,443		14,975
Property taxes receivable		—		—		—		—		439
Accounts receivable		—		—		1		—		232
Long-term receivables, less allowance \$1,500		—		—		—		—		—
Total assets	\$	3,589	\$	93	\$	35,480	\$	20,443	\$	27,090
<b>LIABILITIES, DEFERRED INFLOWS OF RESOURCES AND FUND BALANCES</b>										
Liabilities:										
Accounts payable and other accrued liabilities	\$	—	\$	—	\$	5,253	\$	816	\$	1,137
Due to other funds		—		—		—		—		—
Total liabilities		—		—		5,253		816		1,137
<b>Deferred inflows of resources</b>		—		—		—		—		665
Fund balances:										
<i>unallocated (hide me)</i>		—		—		—		—		—
Nonspendable		—		—		—		—		—
Restricted		3,589		93		30,227		19,627		25,288
Committed		—		—		—		—		—
Total fund balances		3,589		93		30,227		19,627		25,288
Total liabilities, deferred inflows of resources and fund balances	\$	3,589	\$	93	\$	35,480	\$	20,443	\$	27,090

(Continued)

**CITY OF INDIANAPOLIS**  
**(A Component Unit of the Consolidated City of Indianapolis - Marion County)**  
**Combining Balance Sheet – Nonmajor Capital Projects Funds**  
December 31, 2022  
*(In thousands)*

	<b>County Cumulative Capital Improvement</b>	<b>Tax Revenue Note</b>	<b>Public Safety Communications</b>	<b>Landmark Building Preservation</b>	<b>Fire Cumulative</b>	<b>Storm Water</b>
<b>ASSETS</b>						
Equity in pooled cash	\$ 322	\$ —	\$ —	\$ 2	\$ 205	\$ —
Cash and investments with fiscal agents	—	—	—	—	—	15,093
Investments	4,120	—	1,521	23	2,622	—
Property taxes receivable	—	—	—	—	178	—
Accounts receivable	—	—	—	—	76	—
Long-term receivables, less allowance \$1,500	—	—	—	—	—	—
Total assets	\$ 4,442	\$ —	\$ 1,521	\$ 25	\$ 3,081	\$ 15,093
<b>LIABILITIES, DEFERRED INFLOWS OF RESOURCES AND FUND BALANCES</b>						
Liabilities:						
Accounts payable and other accrued liabilities	\$ 14	\$ —	\$ —	\$ —	\$ 134	\$ 3,445
Due to other funds	—	—	—	—	—	1,034
Total liabilities	14	—	—	—	134	4,479
<b>Deferred inflows of resources</b>	—	—	—	—	254	—
Fund balances:						
<i>unallocated (hide me)</i>	—	—	—	—	—	—
Nonspendable	—	—	—	—	—	—
Restricted	4,428	—	1,521	25	2,693	10,614
Committed	—	—	—	—	—	—
Total fund balances	4,428	—	1,521	25	2,693	10,614
Total liabilities, deferred inflows of resources and fund balances	\$ 4,442	\$ —	\$ 1,521	\$ 25	\$ 3,081	\$ 15,093

(Continued)



**CITY OF INDIANAPOLIS**  
**(A Component Unit of the Consolidated City of Indianapolis - Marion County)**  
**Combining Balance Sheet – Nonmajor Capital Projects Funds**  
December 31, 2022  
*(In thousands)*

	<b>Capital Asset Development &amp; Lifecycle</b>	<b>Consolidated City District</b>	<b>Section 108 HUD Loan</b>	<b>Total Nonmajor Capital Projects Funds</b>
<b>ASSETS</b>				
Equity in pooled cash	\$ 9,898	\$ —	\$ 567	\$ 12,171
Cash and investments with fiscal agents	—	93	—	37,097
Investments	126,728	43,911	7,252	249,112
Property taxes receivable	—	—	—	617
Accounts receivable	—	—	—	309
Long-term receivables, less allowance \$1,500	—	—	—	—
Total assets	<u>\$ 136,626</u>	<u>\$ 44,004</u>	<u>\$ 7,819</u>	<u>\$ 299,306</u>
 <b>LIABILITIES, DEFERRED INFLOWS OF RESOURCES AND FUND BALANCES</b>				
Liabilities:				
Accounts payable and other accrued liabilities	\$ 4,412	\$ 757	\$ 7	\$ 15,975
Due to other funds	—	—	—	1,034
Total liabilities	<u>4,412</u>	<u>757</u>	<u>7</u>	<u>17,009</u>
<b>Deferred inflows of resources</b>	<u>—</u>	<u>—</u>	<u>—</u>	<u>919</u>
Fund balances:				
<i>unallocated (hide me)</i>	—	—	—	—
Nonspendable	—	—	—	—
Restricted	71,989	43,247	7,812	221,153
Committed	60,225	—	—	60,225
Total fund balances	<u>132,214</u>	<u>43,247</u>	<u>7,812</u>	<u>281,378</u>
Total liabilities, deferred inflows of resources and fund balances	<u>\$ 136,626</u>	<u>\$ 44,004</u>	<u>\$ 7,819</u>	<u>\$ 299,306</u>

The accompanying notes are an integral part of the financial statements.

**CITY OF INDIANAPOLIS**  
**(A Component Unit of the Consolidated City of Indianapolis - Marion County)**  
**Combining Statement of Revenues, Expenditures, and Changes in Fund Balances – Nonmajor Capital Projects Funds**  
Year ended December 31, 2022  
*(In thousands)*

	<b>Economic Development</b>	<b>PILOT Revenue Bonds</b>	<b>Metropolitan Thoroughfare District</b>	<b>Park District</b>	<b>City Cumulative Capital Improvement</b>
Revenues:					
Taxes	\$ —	\$ —	\$ —	\$ —	\$ 12,826
Other intergovernmental revenues:					
Other revenues	—	—	—	—	—
Interest and other operating revenues	30	—	708	332	1,463
Total revenues	<u>30</u>	<u>—</u>	<u>708</u>	<u>332</u>	<u>14,289</u>
Expenditures:					
Economic development and assistance	5,384	—	—	—	—
Debt service:					
Redemption of bonds, notes and financed purchase obligations	—	—	—	—	826
Interest on bonds and notes	—	—	—	—	101
Bond and note issuance costs	—	—	—	—	8
Lease payments and other	—	—	—	—	1,708
Capital outlays	—	93	37,305	5,132	11,895
Total expenditures	<u>5,384</u>	<u>93</u>	<u>37,305</u>	<u>5,132</u>	<u>14,538</u>
Excess (deficiency) of revenues over (under) expenditures	<u>(5,354)</u>	<u>(93)</u>	<u>(36,597)</u>	<u>(4,800)</u>	<u>(249)</u>
Other financing sources (uses):					
Issuance of lease liabilities	—	—	—	—	—
Bonds, notes and financed purchase obligations issued	—	—	—	—	10,283
Premium on bonds issued	—	—	—	—	—
Transfers in	594	—	—	—	—
Transfers out	(594)	—	—	—	—
Total other financing sources	<u>—</u>	<u>—</u>	<u>—</u>	<u>—</u>	<u>10,283</u>
Net change in fund balances	<u>(5,354)</u>	<u>(93)</u>	<u>(36,597)</u>	<u>(4,800)</u>	<u>10,034</u>
Fund balances at beginning of year	8,943	186	66,824	24,427	15,254
Fund balances at end of year	<u>\$ 3,589</u>	<u>\$ 93</u>	<u>\$ 30,227</u>	<u>\$ 19,627</u>	<u>\$ 25,288</u>

(Continued)

**CITY OF INDIANAPOLIS**  
**(A Component Unit of the Consolidated City of Indianapolis - Marion County)**  
**Combining Statement of Revenues, Expenditures, and Changes in Fund Balances – Nonmajor Capital Projects Funds**  
Year ended December 31, 2022  
*(In thousands)*

	<b>County Cumulative Capital Improvement</b>	<b>Tax Revenue Note</b>	<b>Public Safety Communications</b>	<b>Landmark Building Preservation</b>	<b>Fire Cumulative</b>	<b>Storm Water</b>
Revenues:						
Taxes	\$ —	\$ —	\$ —	\$ —	\$ 4,691	\$ —
Other intergovernmental revenues:						
Other revenues	—	—	—	—	—	—
Interest and other operating revenues	51	—	24	—	29	168
Total revenues	<u>51</u>	<u>—</u>	<u>24</u>	<u>—</u>	<u>4,720</u>	<u>168</u>
Expenditures:						
Economic development and assistance	—	—	—	—	—	—
Debt service:						
Redemption of bonds, notes and financed purchase obligations	—	—	—	—	—	—
Interest on bonds and notes	—	—	—	—	—	—
Bonds and notes issuance costs	—	—	—	—	7	624
Lease payments and other	—	—	—	—	3,179	—
Capital outlays	368	—	90	—	24,135	11,791
Total expenditures	<u>368</u>	<u>—</u>	<u>90</u>	<u>—</u>	<u>27,321</u>	<u>12,415</u>
Excess (deficiency) of revenues over (under) expenditures	<u>(317)</u>	<u>—</u>	<u>(66)</u>	<u>—</u>	<u>(22,601)</u>	<u>(12,247)</u>
Other financing sources (uses):						
Issuance of lease liabilities	—	—	—	—	—	—
Bonds, notes and financed purchase obligations issued	—	—	—	—	22,472	55,632
Premium on bonds issued	—	—	—	—	—	9,769
Transfers in	—	—	—	—	—	—
Transfers out	—	(68)	—	—	(575)	(50,212)
Total other financing sources	<u>—</u>	<u>(68)</u>	<u>—</u>	<u>—</u>	<u>21,897</u>	<u>15,189</u>
Net change in fund balances	<u>(317)</u>	<u>(68)</u>	<u>(66)</u>	<u>—</u>	<u>(704)</u>	<u>2,942</u>
Fund balances at beginning of year	4,745	68	1,587	25	3,397	7,672
Fund balances at end of year	<u>\$ 4,428</u>	<u>\$ —</u>	<u>\$ 1,521</u>	<u>\$ 25</u>	<u>\$ 2,693</u>	<u>\$ 10,614</u>

(Continued)

**CITY OF INDIANAPOLIS**  
**(A Component Unit of the Consolidated City of Indianapolis - Marion County)**  
**Combining Statement of Revenues, Expenditures, and Changes in Fund Balances – Nonmajor Capital Projects Funds**  
Year ended December 31, 2022  
*(In thousands)*

	<b>Capital Asset Development &amp; Lifecycle</b>	<b>Consolidated City District</b>	<b>Section 108 HUD Loan</b>	<b>Total Nonmajor Capital Projects Funds</b>
Revenues:				
Taxes	\$ —	\$ —	\$ —	\$ 17,517
Other intergovernmental revenues:				
Other revenues	762	—	—	762
Interest and other operating revenues	71,989	355	92	75,241
Total revenues	<u>72,751</u>	<u>355</u>	<u>92</u>	<u>93,520</u>
Expenditures:				
Economic development and assistance	—	—	—	5,384
Debt service:				
Redemption of bonds, notes and financed purchase obligations	—	—	—	826
Interest on bonds and notes	—	—	—	101
Bonds and notes issuance costs	—	441	—	1,080
Lease payments and other	—	—	—	4,887
Capital outlays	5,537	35,052	33	131,431
Total expenditures	<u>5,537</u>	<u>35,493</u>	<u>33</u>	<u>143,709</u>
Excess (deficiency) of revenues over (under) expenditures	<u>67,214</u>	<u>(35,138)</u>	<u>59</u>	<u>(50,189)</u>
Other financing sources (uses):				
Issuance of lease liabilities	—	—	—	—
Bonds and notes issued	—	48,886	—	137,273
Premium on bonds issued	—	1,496	—	11,265
Transfers in	40,000	—	3,666	44,260
Transfers out	—	—	—	(51,449)
Total other financing sources	<u>40,000</u>	<u>50,382</u>	<u>3,666</u>	<u>141,349</u>
Net change in fund balances	107,214	15,244	3,725	91,160
Fund balances at beginning of year	25,000	28,003	4,087	190,218
Fund balances at end of year	<u>\$ 132,214</u>	<u>\$ 43,247</u>	<u>\$ 7,812</u>	<u>\$ 281,378</u>

The accompanying notes are an integral part of the financial statements.

**CITY OF INDIANAPOLIS**  
**(A Component Unit of the Consolidated City of Indianapolis - Marion County)**  
**Annually Budgeted Capital Projects Funds**  
**Combining Schedule of Revenues, Expenditures, and Changes in Fund Balances**  
**Budget and Actual – Budgetary Basis**  
Year ended December 31, 2022  
*(In thousands)*

	City Cumulative Capital Improvement		County Cumulative Capital Improvement		Fire Cumulative		Capital Asset Development & Lifecycle		Totals	
	Final budget	Actual	Final budget	Actual	Final budget	Actual	Final budget	Actual	Final budget	Actual
Revenues:										
Taxes	\$ 12,211	\$ 12,825	\$ —	\$ —	\$ 4,516	\$ 4,691	\$ —	\$ —	\$ 16,727	\$ 17,516
Other intergovernmental revenues	—	—	—	—	—	—	—	762	—	762
Interest and other operating revenues	—	1,457	—	51	—	27	1,003	71,989	1,003	73,524
Total revenues	12,211	14,282	—	51	4,516	4,718	1,003	72,751	17,730	91,802
Expenditures:										
Current:										
General government	—	—	—	—	—	—	1,000	1,000	1,000	1,000
Public safety	507	483	—	—	—	—	—	—	507	483
Public works	100	100	—	—	—	—	—	189	100	289
Cultural and recreation	776	671	—	—	—	—	—	—	776	671
Economic development and assistance	600	600	—	—	—	—	—	—	600	600
Capital outlays	10,164	9,345	—	—	4,835	4,810	40,000	2,617	54,999	16,772
Total expenditures	12,147	11,199	—	—	4,835	4,810	41,000	3,806	57,982	19,815
Excess (deficiency) of revenues over (under) expenditures	64	3,083	—	51	(319)	(92)	(39,997)	68,945	(40,252)	71,987
Other financing sources, net:										
Transfers in (out)	1,340	—	—	—	(575)	(575)	40,000	40,000	40,765	39,425
Total other financing sources (uses)	1,340	—	—	—	(575)	(575)	40,000	40,000	40,765	39,425
Revenues over (under) expenditures and other financing sources (uses)	1,404	3,083	—	51	(894)	(667)	3	108,945	513	111,412
Fund balances at beginning of year	1,875	5,643	4,234	4,238	2,548	2,839	—	37,720	8,657	50,440
Cancellation of purchase orders and other	4,126	216	11	—	383	120	(1)	(12,720)	4,519	(12,384)
Fund balances at end of year	\$ 7,405	\$ 8,942	\$ 4,245	\$ 4,289	\$ 2,037	\$ 2,292	\$ 2	\$ 133,945	\$ 13,689	\$ 149,468

**CITY OF INDIANAPOLIS**  
**(A Component Unit of the Consolidated City of Indianapolis - Marion County)**  
**Annually Budgeted Capital Projects Funds**  
**Schedule of Expenditures by Character – Budget and Actual – Budgetary Basis**  
Year ended December 31, 2022  
*(In thousands)*

<u>Department and Division</u>	<u>Fund</u>	<u>Final budget</u>	<u>Actual</u>	<u>Variance</u>
Executive and Legislative				
Office of Finance and Management	Capital Asset Development & Lifecycle			
Other services and charges		\$ 1,000	\$ 1,000	\$ —
Total – Executive and Legislative		<u>\$ 1,000</u>	<u>\$ 1,000</u>	<u>\$ —</u>
Department of Metropolitan Development	City Cumulative Capital Improvement			
Other services and charges		\$ 600	\$ 600	\$ —
Total – Department of Metropolitan Development		<u>\$ 600</u>	<u>\$ 600</u>	<u>\$ —</u>
Department of Business and Neighborhood Services	City Cumulative Capital Improvement			
Capital outlay		\$ 274	\$ 247	\$ 27
Total – Department of Business and Neighborhood Services		<u>\$ 274</u>	<u>\$ 247</u>	<u>\$ 27</u>
Department of Public Works	City Cumulative Capital Improvement			
Other services and charges		\$ 100	\$ 100	\$ —
Capital outlay		460	460	—
Total		<u>\$ 560</u>	<u>\$ 560</u>	<u>\$ —</u>
Department of Public Works	Capital Asset Development & Lifecycle			
Capital outlay		\$ 40,000	\$ 2,806	\$ 37,194
Total		<u>40,000</u>	<u>2,806</u>	<u>37,194</u>
Total – Department of Public Works		<u>\$ 40,560</u>	<u>\$ 3,366</u>	<u>\$ 37,194</u>
Indianapolis Metropolitan Police Department	City Cumulative Capital Improvement			
Supplies		\$ 117	\$ 107	\$ 10
Other services and charges		390	376	14
Capital outlay		5,606	4,848	758
Total - Indianapolis Metropolitan Police Department		<u>\$ 6,113</u>	<u>\$ 5,331</u>	<u>\$ 782</u>
Department of Parks and Recreation	City Cumulative Capital Improvement			
Supplies		\$ 150	\$ 50	\$ 100
Other services and charges		625	621	4
Capital outlay		3,825	3,790	35
Total – Department of Parks and Recreation		<u>\$ 4,600</u>	<u>\$ 4,461</u>	<u>\$ 139</u>
Indianapolis Fire Department	Fire Cumulative			
Capital outlay		\$ 4,835	\$ 4,810	\$ 25
Total – Indianapolis Fire Department		<u>\$ 4,835</u>	<u>\$ 4,810</u>	<u>\$ 25</u>
Total – Capital Projects Funds – by Department and Division		<u>\$ 57,982</u>	<u>\$ 19,815</u>	<u>\$ 38,167</u>

The accompanying notes are an integral part of the financial statements.

## **Internal Service Funds**

Internal Service Funds are used to account for the accumulation of resources to provide for the financing of certain self-insurance programs for all City departments.

The City maintains Risk Management, Public Liability Self-Insurance, and Employee Health Insurance Internal Service Funds.

**CITY OF INDIANAPOLIS**  
**(A Component Unit of the Consolidated City of Indianapolis - Marion County)**  
**Internal Service Funds**  
**Combining Statement of Net Position**  
December 31, 2022  
*(In thousands)*

	<u>Risk Management</u>	<u>Public Liability Self Insurance</u>	<u>Employee Health Insurance</u>	<u>Total</u>
<b>ASSETS</b>				
Equity in pooled cash	\$ 379	\$ 826	\$ 534	\$ 1,739
Cash and investments with fiscal agents	739	—	—	739
Investments	4,852	10,577	6,831	22,260
Accounts receivable	<u>38</u>	<u>—</u>	<u>2,411</u>	<u>2,449</u>
Total current assets	<u>\$ 6,008</u>	<u>\$ 11,403</u>	<u>\$ 9,776</u>	<u>\$ 27,187</u>
 <b>LIABILITIES</b>				
Accounts payable and other current accrued liabilities	<u>8,914</u>	<u>5,642</u>	<u>8,860</u>	<u>23,416</u>
Total current liabilities	<u>8,914</u>	<u>5,642</u>	<u>8,860</u>	<u>23,416</u>
 <b>NET POSITION (DEFICIT)</b>				
Unrestricted (deficit)	<u>(2,906)</u>	<u>5,761</u>	<u>916</u>	<u>3,771</u>
Total liabilities and equity	<u>\$ 6,008</u>	<u>\$ 11,403</u>	<u>\$ 9,776</u>	<u>\$ 27,187</u>

The accompanying notes are an integral part of the financial statements.



**CITY OF INDIANAPOLIS**  
**(A Component Unit of the Consolidated City of Indianapolis - Marion County)**  
**Internal Service Funds**  
**Combining Statement of Revenues, Expenses, and Changes in Fund Net Position**  
Year ended December 31, 2022  
*(In thousands)*

	<u>Risk Management</u>	<u>Public Liability Self Insurance</u>	<u>Employee Health Insurance</u>	<u>Total</u>
Operating revenues:				
Charges to other funds	\$ 7,909	\$ 6,928	\$ 101,142	\$ 115,979
Operating expenses:				
Claims	8,510	8,884	99,959	117,353
Administration	227	—	—	227
Other services and charges	—	—	—	—
Total operating expenses	<u>8,737</u>	<u>8,884</u>	<u>99,959</u>	<u>117,580</u>
Operating income (loss)	(828)	(1,956)	1,183	(1,601)
Nonoperating revenue (expense):				
Interest on investments	93	95	285	473
Income (loss)	<u>(735)</u>	<u>(1,861)</u>	<u>1,468</u>	<u>(1,128)</u>
Change in net position	(735)	(1,861)	1,468	(1,128)
Total net position (deficit) – beginning of year	<u>(2,171)</u>	<u>7,622</u>	<u>(552)</u>	<u>4,899</u>
Total net position (deficit) – end of year	<u>\$ (2,906)</u>	<u>\$ 5,761</u>	<u>\$ 916</u>	<u>\$ 3,771</u>

The accompanying notes are an integral part of the financial statements.

**CITY OF INDIANAPOLIS**  
**(A Component Unit of the Consolidated City of Indianapolis - Marion County)**  
**Internal Service Funds**  
**Combining Statement of Cash Flows**  
Year ended December 31, 2022  
*(In thousands)*

	<u>Risk Management</u>	<u>Public Liability Self Insurance</u>	<u>Employee Health Insurance</u>	<u>Total</u>
Cash flows from operating activities:				
Receipts from users	\$ 7,913	\$ 6,976	\$ 101,688	\$ 116,577
Payments for administration	(227)	—	—	(227)
Payments for claims	<u>(8,840)</u>	<u>(4,641)</u>	<u>(102,940)</u>	<u>(116,421)</u>
Net cash provided by (used in) operating activities	<u>(1,154)</u>	<u>2,335</u>	<u>(1,252)</u>	<u>(71)</u>
Cash flows from investing activities:				
Sales and maturities of investments	—	(2,466)	—	(2,466)
Investment purchases	868	—	700	1,568
Investment income (expense)	<u>93</u>	<u>95</u>	<u>285</u>	<u>473</u>
Net cash provided by (used in) investing activities	<u>961</u>	<u>(2,371)</u>	<u>985</u>	<u>(425)</u>
Net increase (decrease) in cash	(193)	(36)	(267)	(496)
Cash, beginning of year	<u>1,311</u>	<u>862</u>	<u>801</u>	<u>2,974</u>
Cash, end of year	<u>\$ 1,118</u>	<u>\$ 826</u>	<u>\$ 534</u>	<u>\$ 2,478</u>
Reconciliation of operating income (loss) to net cash provided by (used in) operating activities:				
Operating income (loss)	\$ (828)	\$ (1,956)	\$ 1,183	\$ (1,601)
Adjustments to reconcile operating income (loss) to net cash provided by (used in) operating activities:				
Changes in assets and liabilities:				
Decrease (increase) in accounts receivable	4	48	546	598
Increase (decrease) in accounts payable	<u>(330)</u>	<u>4,243</u>	<u>(2,981)</u>	<u>932</u>
Net cash provided by (used in) operating activities	<u>\$ (1,154)</u>	<u>\$ 2,335</u>	<u>\$ (1,252)</u>	<u>\$ (71)</u>

The accompanying notes are an integral part of the financial statements.

## Fiduciary Funds

The Fiduciary Funds are classified into two subgroupings - Custodial Funds and Pension Trust Funds. Funds in this classification are used to account for assets held by the City in a fiduciary capacity. Receipts and expenditures of each fund are governed by terms of trust indentures, statutes, ordinances, etc.

The City maintains the following Fiduciary Funds:

### PENSION TRUST FUNDS

- Police Pension -** to account for the (1) payment of pension benefits to police pensioners that participated in the City pension plan prior to the 1977 Police and Firefighters Pension and Disability Fund (1977 Fund) pension plan and (2) payment of pension benefits to police pensioners that participated in the City pension plan prior to the 1977 Fund and elected to convert to the benefit structure of the 1977 Fund
- Firefighters' Pension -** to account for the (1) payment of pension benefits to firefighter pensioners that participated in the City pension plan prior to the 1977 Police and Firefighters' Pension and Disability Fund pension plan and (2) payment of pension benefits to firefighter pensioners that participated in the City pension plan prior to the 1977 Fund and elected to convert to the benefit structure of the 1977 Fund

### CUSTODIAL FUNDS

- Sanitation 15 Year Law -** to account for property owner assessment receipts held by the City as agent for City-approved developer constructed sewer systems Barrett Law projects, with construction costs repaid by the property owners over a period not to exceed 15 years
- E-911 Allocation -** to account for assets, obligations, and activities of the E-911 dispatch programs
- Police & Fire Retiree Health Insurance -** to account for assets, obligations, and activities of certain Police and Firefighter Retiree Health Insurance costs
- IMPD Confiscated Cash -** to account for assets, obligations, and activities of amounts, which have been confiscated pending final court disposition
- Other -** to account for all contractor receipts for sanitary Barrett Law project engineering fees held by the City as agent for engineer payment upon project acceptance and for franchise security deposits held by the City as agent for franchised performance

**CITY OF INDIANAPOLIS**  
**(A Component Unit of the Consolidated City of Indianapolis - Marion County)**  
**Fiduciary Funds**  
**Combining Statement of Fiduciary Net Position**  
**Pension and Other Postemployment Benefit Trust Funds**  
December 31, 2022  
*(In thousands)*

	<b>Police Pension</b>	<b>Firefighters' Pension</b>	<b>Total</b>
<b>ASSETS</b>			
Equity in pooled cash	\$ 65	\$ 49	\$ 114
City's pooled investments	817	638	1,455
Total assets	882	687	1,569
 <b>LIABILITIES</b>			
Liabilities:			
Total liabilities	—	—	—
 <b>NET POSITION (DEFICIT) RESTRICTED FOR PENSIONS</b>			
Net position restricted for pensions	\$ 882	\$ 687	\$ 1,569

The accompanying notes are an integral part of the financial statements.

**CITY OF INDIANAPOLIS**  
**(A Component Unit of the Consolidated City of Indianapolis - Marion County)**  
**Fiduciary Funds**  
**Combining Statement of Changes in Fiduciary Net Position**  
**Pension and Other Postemployment Benefit Trust Funds**  
Year ended December 31, 2022  
*(In thousands)*

	<u>Police Pension</u>	<u>Firefighters' Pension</u>	<u>Total</u>
<b>ADDITIONS</b>			
Employer contributions	\$ 27,771	\$ 27,498	\$ 55,269
<b>DEDUCTIONS</b>			
Benefits	26,532	26,202	52,734
Total deductions	<u>26,532</u>	<u>26,202</u>	<u>52,734</u>
Net increase (decrease) in net position	1,239	1,296	2,535
Net position restricted for pensions – beginning of year	<u>(357)</u>	<u>(609)</u>	<u>(966)</u>
Net position restricted for pensions – end of year	<u>\$ 882</u>	<u>\$ 687</u>	<u>\$ 1,569</u>

**CITY OF INDIANAPOLIS**  
**(A Component Unit of the Consolidated City of Indianapolis - Marion County)**  
**Fiduciary Funds**  
**Police and Firefighters' Pre-1977 Pension Trust Funds**  
**Budget and Actual – Budgetary Basis**  
Year ended December 31, 2022  
*(In thousands)*

	<b>Police Pension</b>			<b>Firefighters' Pension</b>		
	<b>Budget</b>	<b>Actual</b>	<b>Variance</b>	<b>Budget</b>	<b>Actual</b>	<b>Variance</b>
Revenues:						
Intergovernmental	\$ 30,080	\$ 27,771	\$ (2,309)	\$ 28,298	\$ 27,498	\$ (800)
Total revenues	<u>30,080</u>	<u>27,771</u>	<u>(2,309)</u>	<u>28,298</u>	<u>27,498</u>	<u>(800)</u>
Expenditures:						
Personal services	30,080	26,534	3,546	28,298	26,201	2,097
Total expenditures	<u>30,080</u>	<u>26,534</u>	<u>3,546</u>	<u>28,298</u>	<u>26,201</u>	<u>2,097</u>
Excess (deficiency) of revenues over (under) expenditures	\$ —	\$ 1,237	\$ 1,237	\$ —	\$ 1,297	\$ 1,297
Revenues over (under) expenditures						
Revenues over (under) expenditures and other financing sources	<u>—</u>	<u>1,237</u>	<u>1,237</u>	<u>—</u>	<u>1,297</u>	<u>1,297</u>

The accompanying notes are an integral part of the financial statements.

**CITY OF INDIANAPOLIS**  
**(A Component Unit of the Consolidated City of Indianapolis - Marion County)**  
**Fiduciary Funds**  
**Combining Statement of Fiduciary Net Position**  
**Custodial Funds**  
December 31, 2022  
*(In thousands)*

	<u>Sanitation 15 Year Law</u>	<u>E-911 Allocation</u>	<u>Police and Fire Retiree Health Insurance</u>	<u>IMPD Confiscated Cash</u>	<u>Other</u>	<u>Total</u>
<b>ASSETS</b>						
Equity in pooled cash	\$ 22	\$ —	\$ 11	\$ 372	\$ 55	\$ 460
Investments						
Pooled investments	281	—	137	4,763	713	5,894
Accounts receivable	<u>—</u>	<u>969</u>	<u>—</u>	<u>—</u>	<u>—</u>	<u>969</u>
Total assets	<u>303</u>	<u>969</u>	<u>148</u>	<u>5,135</u>	<u>768</u>	<u>7,323</u>
<b>LIABILITIES</b>						
Accounts payable and other accrued liabilities	<u>—</u>	<u>969</u>	<u>148</u>	<u>—</u>	<u>—</u>	<u>1,117</u>
Total liabilities	<u>—</u>	<u>969</u>	<u>148</u>	<u>—</u>	<u>—</u>	<u>1,117</u>
<b>NET POSITION (DEFICIT)</b>						
Restricted for individuals, organizations, and other governments	<u>\$ 303</u>	<u>\$ —</u>	<u>\$ —</u>	<u>\$ 5,135</u>	<u>\$ 768</u>	<u>\$ 6,206</u>

The accompanying notes are an integral part of the financial statements.

**CITY OF INDIANAPOLIS**  
**(A Component Unit of the Consolidated City of Indianapolis - Marion County)**

**Fiduciary Funds**  
**Combining Statement of Changes in Fiduciary Net Position**  
**Custodial Funds**

Year ended December 31, 2022

*(In thousands)*

	<u>Sanitation 15 Year Law</u>	<u>E-911 Allocation</u>	<u>Police and Fire Retiree Health Insurance</u>	<u>IMPD Confiscated Cash</u>	<u>Other</u>	<u>Total</u>
<b>ADDITIONS</b>						
Employer contributions	\$ —	\$ —	\$ 2,709	\$ —	\$ —	\$ 2,709
Police confiscations	—	—	—	2,508	—	2,508
Fees collected for other governments	—	7,245	—	—	—	7,245
Total Additions	<u>—</u>	<u>7,245</u>	<u>2,709</u>	<u>2,508</u>	<u>—</u>	<u>12,462</u>
<b>DEDUCTIONS</b>						
Benefits paid to participants or beneficiaries	—	—	2,709	—	—	2,709
Court released confiscations	—	—	—	3,351	—	3,351
Payments of fees collected to other governments	—	7,245	—	—	—	7,245
Total deductions	<u>—</u>	<u>7,245</u>	<u>2,709</u>	<u>3,351</u>	<u>—</u>	<u>13,305</u>
Net increase (decrease) in net position	—	—	—	(843)	—	(843)
Net position – beginning of year	<u>303</u>	<u>—</u>	<u>—</u>	<u>5,978</u>	<u>768</u>	<u>7,049</u>
Net position – end of year	<u>\$ 303</u>	<u>\$ —</u>	<u>\$ —</u>	<u>\$ 5,135</u>	<u>\$ 768</u>	<u>\$ 6,206</u>

The accompanying notes are an integral part of the financial statements.



Statistical Section

# Statistical Section

**CITY OF INDIANAPOLIS**

**Statistical Section**

**Table of Contents**

This section of the Comprehensive Annual Financial Report presents detailed information as a context for understanding what the information in the financial statements, note disclosures, and required supplementary information says about the government's overall financial health.

	<u>Schedule #s</u>
<b>FINANCIAL TRENDS</b> These schedules contain trend information to help the reader understand how the government's financial performance and well-being have changed over time.	Schedules 1–5
<b>REVENUE CAPACITY</b> These schedules contain information to help the reader assess the government's most significant local revenue source, the property tax.	Schedules 6–10
<b>DEBT CAPACITY</b> These schedules present information to help the reader assess the affordability of the government's current levels of outstanding debt and the government's ability to issue additional debt in the future.	Schedules 11–15
<b>DEMOGRAPHIC AND ECONOMIC INFORMATION</b> These schedules offer demographic and economic indicators to help the reader understand the environment within which the government's financial activities take place.	Schedules 16–18
<b>OPERATING INFORMATION</b> These schedules contain service and infrastructure data to help the reader understand how the information in the government's financial report relates to the services the government provides and the activities it performs.	Schedules 19–20

Sources: Unless otherwise noted, the information in these schedules is derived from the Comprehensive Annual Financial Reports for the relevant year.

**CITY OF INDIANAPOLIS**  
**Net Position by Component**  
Schedule 1  
Last Ten Fiscal Years  
*(Accrual basis of accounting)*  
*(In thousands)*

	<u>2013</u>	<u>2014</u>	<u>2015</u>	<u>2016</u>	<u>2017</u>	<u>2018</u>	<u>2019</u>	<u>2020</u>	<u>2021</u>	<u>2022</u>
Governmental activities:										
Net investment in capital assets	\$ 682,291	\$ 604,736	\$ 618,860	\$ 658,793	\$ 682,445	\$ 706,470	\$ 676,215	\$ 653,339	\$ 856,341	\$ 973,164
Restricted	122,379	171,863	177,408	180,615	176,332	164,849	166,495	238,525	572,906	433,235
Unrestricted (deficit)	<u>(441,977)</u>	<u>(505,392)</u>	<u>(1,141,617)</u>	<u>(980,497)</u>	<u>(1,016,080)</u>	<u>(998,291)</u>	<u>(1,089,813)</u>	<u>(899,633)</u>	<u>(1,254,617)</u>	<u>(920,638)</u>
Total governmental activities net position (deficit)	<u>\$ 362,693</u>	<u>\$ 271,207</u>	<u>\$ (345,349)</u>	<u>\$ (141,089)</u>	<u>\$ (157,303)</u>	<u>\$ (126,972)</u>	<u>\$ (247,103)</u>	<u>\$ (7,769)</u>	<u>\$ 174,630</u>	<u>\$ 485,761</u>

**CITY OF INDIANAPOLIS**  
**Changes in Net Position**  
Schedule 2  
Last Ten Fiscal Years  
*(Accrual basis of accounting)*  
*(In thousands)*

	<u>2013</u>	<u>2014</u>	<u>2015</u>	<u>2016</u>	<u>2017</u>	<u>2018</u>	<u>2019</u>	<u>2020</u>	<u>2021</u>	<u>2022</u>
<b>Expenses</b>										
Governmental activities:										
General government	\$ 36,467	\$ 43,599	\$ 48,124	\$ 44,689	\$ 44,321	\$ 36,351	\$ 105,277	\$ 73,012	\$ 53,482	\$ 144,690
Public safety	447,016	461,873	412,157	389,302	511,305	436,687	604,609	481,302	480,821	427,683
Public works	204,217	230,470	214,740	163,710	208,581	222,011	281,251	235,308	245,433	268,945
Health and welfare	6,015	6,320	7,555	7,926	7,730	11,594	7,120	39,791	13,886	21,141
Cultural and recreation	18,465	10,130	14,714	15,313	26,059	30,423	24,984	21,974	25,873	33,593
Urban redevelopment and housing	28,124	24,114	18,354	18,899	18,752	23,302	24,120	60,425	151,317	63,483
Economic development and assistance	41,862	33,181	75,451	27,512	30,412	52,671	78,181	55,529	61,089	30,375
Interest	55,480	51,571	51,584	53,919	45,664	49,159	49,415	50,310	50,128	56,702
Total governmental activities expenses	<u>837,646</u>	<u>861,258</u>	<u>842,679</u>	<u>721,270</u>	<u>892,824</u>	<u>862,198</u>	<u>1,174,957</u>	<u>1,017,651</u>	<u>1,082,029</u>	<u>1,046,612</u>
<b>Program Revenues</b>										
Governmental activities:										
Charges for services:										
General government	22,245	21,785	25,881	17,468	14,703	18,857	18,277	14,701	15,514	13,891
Public safety	19,698	23,679	29,080	29,549	30,475	32,110	32,049	30,902	32,046	29,090
Public works	37,427	38,896	43,184	52,597	52,641	57,340	59,977	59,412	61,500	66,152
Health and welfare	675	808	149	264	1,214	94	177	37	136	59
Cultural and recreation	3,129	3,638	3,714	4,036	3,396	3,583	3,358	2,557	3,756	4,261
Urban redevelopment and housing	1,330	1,835	2,050	2,008	2,451	2,224	2,045	1,999	1,914	2,208
Economic development and assistance	1,051	1,530	1,259	7,222	1,148	961	1,399	1,915	1,379	1,779
Operating grants and contributions	138,311	137,828	139,251	134,890	133,040	151,026	209,824	343,609	321,159	431,033
Capital grants and contributions	77,797	4,845	37,351	34,023	20,072	12,215	15,262	42,026	20,655	10,079
Total governmental activities program revenues	<u>301,663</u>	<u>234,844</u>	<u>281,919</u>	<u>282,057</u>	<u>259,140</u>	<u>278,410</u>	<u>342,368</u>	<u>497,158</u>	<u>458,059</u>	<u>558,552</u>
<b>Net (Expense) Revenue</b>	<u>(535,983)</u>	<u>(626,414)</u>	<u>(560,760)</u>	<u>(439,213)</u>	<u>(633,684)</u>	<u>(583,788)</u>	<u>(832,589)</u>	<u>(520,493)</u>	<u>(623,970)</u>	<u>(488,060)</u>
<b>General Revenues and Other Changes in Net Position</b>										
Governmental activities:										
Taxes:										
Property tax	280,883	297,487	285,649	300,101	294,886	315,230	333,060	349,786	364,859	372,310
Wheel tax	12,983	13,250	14,645	13,644	14,843	15,354	15,527	16,000	16,409	15,623
County option income tax	154,273	164,582	206,838	266,834	230,417	237,319	272,699	303,772	327,197	297,989
Other taxes	19,949	21,460	20,472	21,967	23,085	23,159	23,641	25,075	26,654	27,204
Grants and contributions not restricted by function	12,978	13,165	9,465	10,017	12,224	12,439	12,808	13,317	25,168	10,573
Investment earnings not restricted by function	3,416	7,984	6,373	9,977	14,249	16,302	20,131	16,353	12,870	22,828
Miscellaneous	20,133	17,000	28,675	20,933	27,766	29,269	34,592	35,524	33,212	34,841
Total governmental activities general revenues and other changes in net position	<u>504,615</u>	<u>534,928</u>	<u>572,117</u>	<u>643,473</u>	<u>617,470</u>	<u>649,072</u>	<u>712,458</u>	<u>759,827</u>	<u>806,369</u>	<u>781,368</u>
<b>Change in Net Position</b>										
Governmental activities	<u>\$ (31,368)</u>	<u>\$ (91,486)</u>	<u>\$ 11,357</u>	<u>\$ 204,260</u>	<u>\$ (16,214)</u>	<u>\$ 65,284</u>	<u>\$ (120,131)</u>	<u>\$ 239,334</u>	<u>\$ 182,399</u>	<u>\$ 293,308</u>

**CITY OF INDIANAPOLIS**  
**Program Revenues by Function/Program**  
Schedule 3  
Last Ten Fiscal Years  
*(Accrual basis of accounting)*  
*(In thousands)*

	<u>2013</u>	<u>2014</u>	<u>2015</u>	<u>2016</u>	<u>2017</u>	<u>2018</u>	<u>2019</u>	<u>2020</u>	<u>2021</u>	<u>2022</u>
<b>Function/Program</b>										
Governmental activities:										
General government	\$ 28,022	\$ 28,433	\$ 29,935	\$ 20,722	\$ 29,328	\$ 26,080	\$ 82,343	\$ 188,876	\$ 24,793	\$ 36,094
Public safety	91,203	89,255	91,716	93,854	96,521	93,984	98,554	100,429	101,087	103,254
Public works	139,321	88,035	118,727	125,176	103,100	128,741	131,296	170,651	149,683	155,070
Health and welfare	7,118	6,807	7,302	6,547	7,411	7,357	7,216	7,082	154,502	161,036
Cultural and recreation	11,527	4,865	8,845	7,290	5,905	5,793	5,865	7,422	10,725	77,704
Urban redevelopment and housing	15,832	13,373	22,314	17,152	14,888	14,657	14,945	19,851	15,297	20,141
Economic development and assistance	8,640	4,076	3,080	11,316	1,987	1,798	2,149	2,847	1,972	5,253
<b>Total governmental activities program revenues</b>	<u>\$ 301,663</u>	<u>\$ 234,844</u>	<u>\$ 281,919</u>	<u>\$ 282,057</u>	<u>\$ 259,140</u>	<u>\$ 278,410</u>	<u>\$ 342,368</u>	<u>\$ 497,158</u>	<u>\$ 458,059</u>	<u>\$ 558,552</u>

**CITY OF INDIANAPOLIS**  
**Fund Balances - Governmental Funds**  
Schedule 4  
Last Ten Fiscal Years  
*(Modified accrual basis of accounting)*  
*(In thousands)*

	Fiscal Year									
	2013	2014	2015	2016	2017	2018	2019	2020	2021	2022
General Fund:										
Restricted	\$ 42,256	\$ 32,069	\$ 35,306	\$ 89,454	\$ 105,276	\$ 85,591	\$ 87,641	\$ 85,604	\$ 93,833	\$ 91,746
Committed	70,457	37,992	9,207	2,749	659	5,040	10,861	30,518	52,209	12,273
Assigned	76,815	83,902	79,775	77,923	77,726	76,505	85,825	111,348	134,095	105,202
Unassigned	91,191	70,784	79,192	94,093	99,761	107,099	104,667	168,492	142,409	118,588
Total General Fund	<u>\$ 280,719</u>	<u>\$ 224,747</u>	<u>\$ 203,480</u>	<u>\$ 264,219</u>	<u>\$ 283,422</u>	<u>\$ 274,235</u>	<u>\$ 288,994</u>	<u>\$ 395,962</u>	<u>\$ 422,546</u>	<u>\$ 327,809</u>
All other governmental funds:										
Nonspendable	\$ 3,138	\$ 2,275	\$ 1,959	\$ 1,180	\$ 357	\$ 362	\$ 370	\$ 372	\$ 372	\$ 376
Restricted	221,517	271,375	317,629	308,953	361,601	374,569	435,459	454,775	473,332	710,059
Committed	—	—	—	—	—	—	—	—	25,000	60,225
Assigned	—	—	—	—	—	—	—	—	—	—
Unassigned	(2,155)	(364)	(322)	(68)	—	—	—	—	(9,265)	(10,264)
Total all other governmental funds	<u>\$ 222,500</u>	<u>\$ 273,286</u>	<u>\$ 319,266</u>	<u>\$ 310,065</u>	<u>\$ 361,958</u>	<u>\$ 374,931</u>	<u>\$ 435,829</u>	<u>\$ 455,147</u>	<u>\$ 489,439</u>	<u>\$ 760,396</u>

**CITY OF INDIANAPOLIS**  
**Changes in Fund Balances - Governmental Funds**  
Schedule 5  
Last Ten Fiscal Years  
*(Modified accrual basis of accounting)*  
*(In thousands)*

	2013	2014	2015	2016	2017	2018	2019	2020	2021	2022
<b>Revenues:</b>										
Taxes	\$ 467,820	\$ 497,061	\$ 529,231	\$ 601,328	\$ 563,213	\$ 590,330	\$ 642,666	\$ 694,410	\$ 736,102	\$ 713,210
Licenses and permits	13,457	12,010	14,249	13,952	14,362	15,974	17,834	15,594	16,072	17,770
Charges for services	58,826	63,949	65,744	76,844	75,395	80,594	83,320	80,551	83,890	84,147
Intergovernmental revenues	164,365	151,369	154,789	146,074	149,804	157,487	160,836	345,914	335,430	338,173
Intragovernmental revenues	4,880	3,286	2,342	1,909	2,974	11,327	7,420	7,521	11,249	8,047
Traffic violations and court fees	5,429	5,112	5,822	6,771	5,861	7,025	5,590	6,689	6,236	6,605
Interest and other operating revenues	31,816	46,174	57,835	53,004	55,987	51,818	116,588	59,297	52,301	142,635
<b>Total revenues</b>	<b>746,593</b>	<b>778,961</b>	<b>830,012</b>	<b>899,882</b>	<b>867,596</b>	<b>914,555</b>	<b>1,034,254</b>	<b>1,209,976</b>	<b>1,241,280</b>	<b>1,310,587</b>
<b>Expenditures:</b>										
Current:										
General government	21,721	25,957	24,888	24,720	26,591	29,174	41,093	41,200	49,537	160,337
Public safety	416,774	429,520	442,491	452,435	469,029	484,947	496,092	529,844	531,564	561,426
Public works	101,172	114,061	107,819	107,520	101,343	114,599	124,049	130,816	128,412	127,102
Health and welfare	5,973	6,241	7,550	7,832	7,694	7,778	7,211	40,082	14,123	21,187
Cultural and recreation	13,864	13,031	13,267	14,910	24,606	23,816	24,682	25,745	26,276	28,869
Urban redevelopment and housing	24,033	17,760	22,731	17,641	14,023	18,476	18,567	56,821	146,714	58,390
Economic development and assistance	37,981	28,411	61,202	20,163	27,326	23,327	44,627	52,594	58,039	27,136
Capital outlays	105,394	84,975	122,022	78,901	134,973	205,552	203,925	210,516	164,478	252,256
Debt service:										
Redemption of bonds and notes	61,598	76,953	69,066	72,787	83,575	94,026	188,013	87,544	179,519	204,076
Interest on bonds and notes	51,981	47,877	45,915	49,835	53,807	42,353	42,237	76,914	44,265	46,855
Swap termination payment	—	—	—	—	—	—	—	—	—	—
Bond and note issuance costs	5,705	1,099	2,445	1,358	3,288	2,670	2,129	2,401	2,265	4,806
Advance funding escrow	36,705	10,525	11,655	—	—	—	—	—	—	—
Operating lease payments and administration	16,047	16,184	18,448	16,662	2,337	4,808	3,123	25,962	2,704	20,640
<b>Total expenditures</b>	<b>898,948</b>	<b>872,594</b>	<b>949,499</b>	<b>864,764</b>	<b>948,592</b>	<b>1,051,526</b>	<b>1,195,748</b>	<b>1,280,439</b>	<b>1,347,896</b>	<b>1,513,080</b>
Excess (deficiency) of revenues under expenditures	(152,355)	(93,633)	(119,487)	35,118	(80,996)	(136,971)	(161,494)	(70,463)	(106,616)	(202,493)
<b>Other financing sources (uses):</b>										
Proceeds of financing from capital lease	—	605	3,248	—	—	4,972	29,566	8,596	9,378	8,346
Proceeds from execution of parking meter contract	—	—	—	—	—	—	—	—	—	—
Proceeds from restructuring of debt	85	212	749	—	—	—	—	—	—	—
Sales of capital assets	795	625	472	1,264	1,153	739	2,077	2,768	734	1,495
Bonds and notes issued	5,780	69,370	116,600	10,707	128,132	118,627	180,490	142,353	69,014	294,359
Premium on bonds and notes issued	11,744	6,215	12,146	6,609	31,522	4,217	25,018	12,479	15,301	31,973
Refunding bonds issued	86,605	11,420	10,985	50,325	150,800	12,202	—	148,513	73,065	42,540
Payment to refunded bond escrow agent	(53,545)	—	—	(52,485)	(159,515)	—	—	(117,960)	—	—
Transfers in	102,216	53,138	128,974	98,909	102,286	184,829	188,575	288,487	224,375	277,800
Transfers out	(102,216)	(53,138)	(128,974)	(98,909)	(102,286)	(184,829)	(188,575)	(288,487)	(224,375)	(277,800)
<b>Total other financing sources (uses)</b>	<b>51,464</b>	<b>88,447</b>	<b>144,200</b>	<b>16,420</b>	<b>152,092</b>	<b>140,757</b>	<b>237,151</b>	<b>196,749</b>	<b>167,492</b>	<b>378,713</b>
Net change in fund balances (deficits)	\$ (100,891)	\$ (5,186)	\$ 24,713	\$ 51,538	\$ 71,096	\$ 3,786	\$ 75,657	\$ 126,286	\$ 60,876	\$ 176,220
Debt service as a percentage of noncapital expenditures	15%	17%	15%	15%	16%	16%	23%	15%	19%	19%
Debt service expenditures	\$ 113,579	\$ 124,830	\$ 114,981	\$ 122,622	\$ 137,382	\$ 136,379	\$ 230,250	\$ 164,458	\$ 223,784	\$ 250,931
Noncapital expenditures	781,499	721,252	768,280	793,994	846,477	878,890	1,023,315	1,084,289	1,196,381	1,327,855



**CITY OF INDIANAPOLIS**  
**Tax Revenues by Source - Governmental Funds**  
Schedule 6  
Last Ten Fiscal Years  
*(Modified accrual basis)*  
*(In thousands)*

<b>Fiscal year</b>	<b>Property</b>	<b>Local income tax</b>	<b>Wheel tax</b>	<b>Other (a)</b>	<b>Total taxes</b>
2013	\$ 280,596	\$ 154,273	\$ 12,978	\$ 19,973	\$ 467,820
2014	297,905	164,582	13,250	21,324	497,061
2015	287,170	206,838	14,645	20,579	529,232
2016	299,225	266,834	13,644	21,625	601,328
2017	295,484	230,417	14,843	22,469	563,213
2018	316,100	237,319	15,354	22,574	591,347
2019	331,187	272,699	15,527	23,253	642,666
2020	349,786	303,772	16,000	25,075	694,633
2021	366,080	327,197	16,409	26,416	736,102
2022	372,651	297,989	15,623	26,947	713,210

(a) Includes financial institution and other local taxes.

**CITY OF INDIANAPOLIS**  
**Assessed Value and Estimated Actual Value of Taxable Property**  
Schedule 7  
Last Ten Fiscal Years  
*(In thousands)*

<b>Fiscal year</b>	<b>Residential property (c)</b>	<b>Commercial property (c)</b>	<b>Industrial property (c)</b>	<b>Personal property (c)</b>	<b>Other (c)</b>	<b>Total taxable assessed value (a) (b)</b>	<b>Total direct tax rate</b>	<b>Estimated actual taxable value</b>	<b>Taxable assessed value as a % of actual taxable value (a)</b>
2013	16,191,259	13,110,440	3,189,252	5,841,671	888,684	39,221,306	0.9802	39,221,306	100
2014	18,171,183	13,464,533	3,103,892	5,972,597	842,391	41,554,596	0.7667	41,554,596	100
2015	18,103,687	13,437,532	3,096,297	6,160,989	977,912	41,776,417	0.7069	41,776,417	100
2016	18,531,258	13,631,932	3,139,384	6,325,056	903,782	42,531,412	0.7136	42,531,412	100
2017	19,125,058	13,538,083	3,066,967	6,659,770	885,892	43,275,770	0.7313	43,275,770	100
2018	19,839,568	14,114,626	3,150,699	6,700,531	894,001	44,699,425	0.7243	44,699,425	100
2019	21,199,690	14,886,845	3,244,769	6,837,711	910,314	47,079,329	0.7092	47,079,329	100
2020	23,259,818	15,085,633	3,378,670	6,906,428	956,093	49,586,642	0.7040	49,586,642	100
2021	25,141,091	15,524,519	3,542,094	7,095,509	948,461	52,251,674	0.6973	52,251,674	100
2022	27,631,773	15,579,045	3,623,218	7,133,793	988,396	54,956,225	0.6796	54,956,225	100

Note: Tax-exempt property for 2022 of \$5,736,952 represents charitable organizations and other deductions. Government property is generally not assessed.

- (a) Represents the assessment (Marion County Auditor's "certified abstract") on January 1 of the prior year for taxes due and payable in the year indicated.
- (b) In 2022, total taxable assessed value includes \$5,817,137 of assessed valuation for Marion County Tax Increment Financing Districts.
- (c) Provided by the Marion County Treasurer

**CITY OF INDIANAPOLIS**  
**Direct and Overlapping Governments - Property Tax Rates (a) (b)**  
Schedule 8  
Last Ten Fiscal Years  
*(Rate per \$100 of assessed value)*

Fiscal Year	City of Indianapolis			County direct rates		Overlapping rates			Total direct and overlapping rates
	Operating millage	Debt service millage	Total city millage	County	Municipal corporations	Total City-County Council approved	School	Other	
2013	\$ 0.9069	\$ 0.0733	\$ 0.9802	\$ 0.3932	\$ 0.4314	\$ 1.8048	\$ 1.4829	\$ 0.0607	\$ 3.3484
2014	0.6795	0.0872	0.7667	0.4034	0.4340	1.6041	1.2889	0.0620	2.9550
2015	0.6431	0.0638	0.7069	0.3825	0.4205	1.5099	1.3504	0.0607	2.9210
2016	0.6554	0.0582	0.7136	0.3883	0.4454	1.5473	1.4170	0.0630	3.0273
2017	0.6742	0.0571	0.7313	0.3943	0.4517	1.5773	0.9735	0.0619	2.6127
2018	0.6716	0.0527	0.7243	0.3893	0.4488	1.5624	1.1336	0.0587	2.7547
2019	0.6636	0.0456	0.7092	0.3906	0.4496	1.5494	1.5032	0.0563	3.1089
2020	0.6540	0.0500	0.7040	0.3869	0.4383	1.5292	1.4284	0.0568	3.0144
2021	0.6507	0.0466	0.6973	0.3931	0.4368	1.5272	1.3785	0.0559	2.9616
2022	0.6488	0.0308	0.6796	0.4063	0.4371	1.5230	1.3884	0.0551	2.9665

- (a) Rate of District 101 (Indianapolis-Center Township), which is the only rate that includes all major services.  
(b) Data presented is per the tax rate schedule certified by the Department of Local Government Finance (DLGF).

**CITY OF INDIANAPOLIS**  
**Principal Property Tax Payers**  
Schedule 9  
Current Fiscal Year and Nine Years Ago  
*(In thousands)*

	2022				2013		
	Taxable assessed value (a)	Rank	Percentage of total city taxable assessed value		Principal taxpayers	Taxable assessed value (b) (c)	Rank
Eli Lilly and Company	\$ 1,439,069	1	2.619 %	Eli Lilly and Company	\$ 1,130,547	1	2.882 %
Citizens Energy Group	528,378	2	0.961	Citizens Energy Group	440,801	2	1.124
Federal Express Corporation	278,081	3	0.506	Indianapolis Power & Light Co.	408,967	3	1.043
White Legacy Properties, LLC	210,020	4	0.382	Convention Headquarters Hotels, LLC	174,342	4	0.445
Allison Transmission Inc.	191,793	5	0.349	Federal Express Corporation	165,049	5	0.421
Hertz Indianapolis 111 Monument, LLC	156,989	6	0.286	Cw Monument Circle Inc.	142,726	6	0.364
Rolls-Royce Corporation	135,207	7	0.246	Indiana Bell Telephone Company, Inc.	135,904	7	0.347
American United Life Insurance Company	106,676	8	0.194	Allison Transmission Inc.	120,901	8	0.308
Indianapolis Power and Light Company	101,255	9	0.184	American United Life Insurance Company	97,784	9	0.249
G&I IX MJW Keystone Crossing, LLC	101,086	10	0.184	Castleton Square, LLC	90,661	10	0.231
SVC Manufacturing Inc.	92,458	11	0.168	Rolls Royce	80,618	11	0.206
MSA North Developer LLC	88,391	12	0.161	SVC Manufacturing	80,606	12	0.206
Cellco Partnership	82,774	13	0.151	Indianapolis Motor Speedway, LLC	79,736	13	0.203
Castleton Square, LLC	82,723	14	0.151	Keystone Investors, LLC	79,545	14	0.203
IMD2 LLC	79,486	15	0.145	Ingredion Inc.	73,799	15	0.188
Comcast of Indianapolis LP	73,252	16	0.133	Circle Centre Development Company	69,406	16	0.177
Westin Indianapolis LLC	71,976	17	0.131	Verizon Wireless	66,482	17	0.170
Axis FC LLC	71,179	18	0.130	Hub Properties GA, LLC	62,116	18	0.158
Corteva Agriscience LLC	65,779	19	0.120	MT Acquisitions, LLC	61,389	19	0.157
Indianapolis Motor Speedway LLC	64,731	20	0.118	Hertz Indianapolis Two, LLC	52,371	20	0.134
	<u>\$ 4,021,303</u>		<u>7.319</u>		<u>\$ 3,613,750</u>		<u>9.216</u>

- (a) Represents the January 1, 2021 valuations for taxes due and payable in 2022 as represented by the taxpayer. Amounts in thousands. Net assessed valuation was determined using public records from the Marion County Treasurer's Office.
- (b) Represents the March 1, 2012 valuations for taxes due and payable in 2013 as represented by the taxpayer. Amounts in thousands. Net assessed valuation was determined using public records from the Marion County Treasurer's Office.
- (c) Data presented as originally published in the 2013 Comprehensive Annual Financial Report.

**CITY OF INDIANAPOLIS**  
**Property Tax Levies and Collections**  
Schedule 10  
Last Ten Fiscal Years  
*(In thousands)*

<b>Fiscal year ended December 31</b>	<b>Taxes levied for the fiscal year</b>	<b>Collected within the fiscal year of the levy</b>		<b>Collections in subsequent years</b>	<b>Total collections to date</b>	
		<b>Amount</b>	<b>Percentage of levy</b>		<b>Amount (a)</b>	<b>Percentage of levy</b>
2013	\$ 186,122	\$ 177,333	95.3 %	\$ 6,772	\$ 184,105	98.9 %
2014	214,798	207,089	96.4	6,286	213,375	99.3
2015	195,944	189,917	96.9	4,913	194,830	99.4
2016	194,983	187,224	96.0	6,639	193,863	99.4 (b)
2017	217,161	210,628	97.0	5,667	216,295	99.6
2018	214,321	207,816	97.0	6,135	213,951	99.8
2019	224,783	212,813	94.7	7,776	220,589	98.1
2020	223,480	214,454	96.0	7,603	222,057	99.4
2021	231,911	223,857	96.5	6,506	230,363	99.3
2022	231,670	223,808	96.6	—	223,808	96.6

(a) Tax increment revenues are not included in the collected amounts because there is no separate tax levy for them.

(b) During 2013 an administrative process was completed to validate property owners who were receiving a homestead deduction. Those property owners with multiple homestead deductions were notified by the County to validate the homestead deduction or they would have this deduction removed. This verification process increased base assessed value in and resulted in additional one-time property tax revenue.

**CITY OF INDIANAPOLIS**  
**Ratios of Outstanding Debt by Type (c )**  
Schedule 11  
Last Ten Fiscal Years  
*(In thousands, except per capita)*

<b>Governmental activities</b>											
<b>Fiscal year</b>	<b>Notes</b>							<b>Financed Purchase Obligations</b>	<b>Total Governmental Activities Debt</b>	<b>Percentage of personal income (a)</b>	<b>Per capita (a)</b>
	<b>General obligation bonds</b>	<b>Tax increment bonds</b>	<b>Revenue bonds</b>	<b>payable and certificates of participation</b>	<b>Capital leases (d)</b>	<b>Lease Liabilities</b>					
2013	\$ 180,800	\$ 626,551	\$ 260,150	(b) 28,732	\$ 8,038	—	—	\$ 1,104,271	2.63%	\$ 1,307	
2014	157,574	669,880	271,520	40,422	8,549	—	—	1,147,945	2.65%	1,350	
2015	129,860	649,323	345,558	74,633	11,607	—	—	1,210,981	2.67%	1,418	
2016	85,898	624,750	335,028	82,197	10,619	—	—	1,138,492	2.44%	1,325	
2017	135,822	602,630	332,753	119,288	9,659	—	—	1,200,152	2.51%	1,390	
2018	124,440	598,565	360,653	166,076	12,182	—	—	1,261,916	2.49%	1,449	
2019	121,652	614,661	453,785	104,601	39,997	—	—	1,334,696	2.54%	1,523	
2020	324,760	623,875	316,043	119,772	28,473	—	—	1,412,923	2.47%	1,592	
2021	344,837	592,530	296,342	130,723	41,291	—	—	1,405,723	2.21%	1,596	
2022	349,908	713,204	337,399	91,905	—	46,131	31,929	1,570,476	2.46%	1,783	

- (a) See schedule 16 for personal income and population data.
- (b) Effective August 26, 2011, the City's water and wastewater utilities were sold to Citizens Energy Group. As part of the sale, CEG assumed \$1,408,369 of revenue bonds and agreed to fund the remaining sanitary district general obligation debt in the amount of \$41,803, which matured in 2018.
- (c) Outstanding bond amounts include deferred premiums.
- (d) Capital lease balances prior to the implementation of GASB Statement No. 87, Leases, in 2022

**CITY OF INDIANAPOLIS**  
**Ratios of Net General Bonded Debt Outstanding (c)**  
Schedule 12  
Last Ten Fiscal Years  
*(In thousands, except per capita)*

Fiscal year	Net general bonded debt outstanding			Total	Percentage of actual taxable value of property (b)	Per capita (a)
	General obligation bonds	Less: Amounts available in debt service fund				
2013	\$ 180,800	\$ 20,275	\$	160,525	0.409 %	\$ 190.33
2014	157,574	21,255		136,319	0.328	160.60
2015	129,860	24,850		105,010	0.251	121.71
2016	85,898	8,727		77,171	0.181	90.24
2017	135,822	9,055		126,767	0.293	146.81
2018	124,440	15,395		109,045	0.244	125.20
2019	121,652	15,930		105,722	0.225	120.63
2020	324,760	17,525		307,235	0.620	346.12
2021	344,837	13,265		331,572	0.635	376.52
2022	349,908	10,085		339,823	0.618	385.89

Note: Details regarding the City's outstanding debt can be found in the notes to the financial statements.

- (a) Population data can be found in schedule 16.
- (b) Property value data can be found in schedule 7.
- (c) Outstanding bond amounts include deferred premiums.

**CITY OF INDIANAPOLIS**  
**Schedule of Direct and Overlapping Debt and Bonded Debt Limit (a)**  
Schedule 13  
December 31, 2022  
(In thousands)

	Map reference (see introduction (e))	Assessed value (d)	Bonding limit		Bonds outstanding (h)
			%	Dollar amount	
<b>Direct Debt:</b>					
<b>City of Indianapolis:</b>					
Civil City	2	\$ 45,984,079	0.67%	\$ 308,093	\$ 66,590
Park District	1	49,139,088	0.67%	329,232	23,930
Redevelopment District	2	45,984,079	(f)	—	—
Flood Control District	1	49,139,088	0.67%	329,232	—
Metropolitan Thoroughfare District	1	49,139,088	1.33%	653,550	199,585
Solid Waste Special Service District	7	46,053,015	2.00%	921,060	—
Public Safety Communications and Computer Facilities District	1	49,139,088	0.67%	329,232	37,655
Premium on General Obligation Debt				—	22,148
Total City General Obligation Debt				<u>\$ 2,870,399</u>	<u>349,908</u>
<b>Other Direct Debt (i)</b>					
Tax increment bonds					713,204
Revenue bonds					337,399
Notes payable					91,905
Lease liabilities					46,131
Financed purchase obligations					31,929
<b>Total City Direct Debt</b>					<u>\$ 1,570,476</u>
<b>Overlapping:</b>					
Marion County	1	\$ 49,139,088	0.67%	<u>\$ 329,232</u>	<u>\$ —</u>
Municipal Corporations:					
Indianapolis Airport Authority	1	\$ 49,139,088	0.67%	\$ 329,232	\$ —
Health and Hospital Corporation	1	49,139,088	0.67%	329,232	158,680
Capital Improvement Board of Managers	1	49,139,088	0.67%	329,232	—
Indianapolis-Marion County Building Authority	1	49,139,088	(b)	—	—
Indianapolis-Marion County Public Library	4	48,447,030	0.67%	324,595	62,510
Indianapolis Public Transportation Corporation	2	46,536,467	0.67%	311,794	—
Total Municipal Corporations		<u>291,539,849</u>		<u>\$ 1,624,085</u>	<u>\$ 221,190</u>
<b>School Districts:</b>					
Beech Grove	8	\$ 523,700	(g)	\$ 3,509	\$ 5,699
Decatur	8	1,846,690	(g)	12,373	10,990
Franklin	8	3,302,687	(g)	22,128	9,325
Indianapolis Public Schools	8	13,858,771	(g)	92,854	90,455
Lawrence	8	5,856,802	(g)	39,241	19,005
Perry	8	4,369,096	(g)	29,273	22,139

(Continued)



**CITY OF INDIANAPOLIS**  
**Schedule of Direct and Overlapping Debt and Bonded Debt Limit (a)**  
Schedule 13  
December 31, 2022  
*(In thousands)*

	Map reference (see introduction (e))	Assessed value (d)	Bonding limit		Bonds outstanding (h)
			%	Dollar amount	
<b>School Districts (continued):</b>					
Pike	8	\$ 5,377,537	(g)	\$ 36,029	\$ 27,875
Speedway	8	692,059	(g)	4,637	1,005
Warren	8	3,111,117	(g)	20,844	9,810
Washington	8	6,809,026	(g)	45,620	26,530
Wayne	8	3,624,511	(g)	24,284	5,970
Total School Districts		<u>\$ 49,371,996</u>		<u>\$ 330,792</u>	<u>\$ 228,803</u>
<b>Other Cities and Towns:</b>					
Beech Grove	2	\$ 552,386	0.67%	\$ 3,701	\$ 120
Lawrence	2	1,841,627	0.67%	12,339	1,298
Southport	2	68,936	0.67%	462	33
Speedway	2	692,059	0.67%	4,637	4,395
Total Other Cities and Towns		<u>\$ 3,155,008</u>		<u>\$ 21,139</u>	<u>\$ 5,846</u>
<b>Townships:</b>					
Center	3	\$ 8,158,462	0.67%	\$ 54,662	\$ —
Decatur	3	1,846,690	0.67%	12,373	—
Franklin	3	3,446,464	0.67%	23,091	—
Lawrence	3	6,295,631	0.67%	42,181	2,460
Perry	3	4,779,999	0.67%	32,026	—
Pike	3	5,218,292	0.67%	34,963	—
Warren	3	4,220,136	0.67%	28,275	—
Washington	3	9,814,923	0.67%	65,760	—
Wayne	3	5,082,059	0.67%	34,050	263
Total Townships		<u>\$ 48,862,656</u>		<u>\$ 327,381</u>	<u>\$ 2,723</u>
<b>Excluded Library Districts:</b>					
Speedway	4	692,059	0.67%	\$ 4,637	\$ 45
Total Excluded Library Districts		<u>\$ 692,059</u>		<u>\$ 4,637</u>	<u>\$ 45</u>
Ben Davis Conservancy District		<u>\$ 434,231</u>	(c)	<u>\$ —</u>	<u>\$ —</u>
Total overlapping debt					<u>\$ 458,607</u>
Total direct and overlapping debt					<u>\$ 2,029,083</u>

(Continued)

**CITY OF INDIANAPOLIS**  
**Schedule of Direct and Overlapping Debt and Bonded Debt Limit (a)**  
Schedule 13  
December 31, 2022  
*(In thousands)*

- (a) Excludes revenue bonds not payable from ad valorem taxes.
- (b) There is no debt limit for the Indianapolis-Marion County Building Authority. Its debt service requirements are funded by rentals paid by the City of Indianapolis and Marion County from ad valorem taxes mandated by the Building Authority's enabling legislation.
- (c) Ben Davis Conservancy District has no bonding limit. Bonds are payable from either collection of special benefit taxes or revenues produced from the project per Indiana Code 14-33-11-4.
- (d) Represents the January 1, 2021 (Marion County Auditor's "certified abstract") assessment for taxes due and payable in 2022.
- (e) See Introductory Section.
- (f) There is no statutory constitutional debt limitation to the Redevelopment Districts.
- (g) A statutory 0.67% limit on school district debt does not apply to any debt that is incurred by a school district building corporation for the purpose of constructing facilities to be leased to the school district at rentals sufficient to fund the corporation's annual debt service requirements. The bonding limit shown is the sum of the statutory limit and does not include the outstanding building corporation debt.
- (h) Governmental activities debt of the overlapping governments is not readily available; only general obligation debt is reported in this column.
- (i) Other direct debt outstanding includes deferred premiums.

Source: All outstanding debt for the overlapping governments can be found on Indiana Gateway. [gateway.ifionline.org](http://gateway.ifionline.org)

**CITY OF INDIANAPOLIS**  
**Computation of Legal Debt Margin (a)(c)**  
Schedule 14  
December 31, 2022  
*(In thousands)*

	<u>Assessed value</u>	<u>Debt limit percentage</u>	<u>Debt limit</u>	<u>Bonds outstanding</u>	<u>Legal debt margin</u>	<u>Total net debt applicable to the limit as a percentage of debt limit</u>
Civil City	\$ 45,984,079	0.67%	\$ 308,093	\$ 66,590	\$ 241,503	21.61%
Park District	49,139,088	0.67%	329,232	23,930	305,302	7.27%
Redevelopment District	45,984,079	(b)	—	—	—	0.00%
Flood Control District	49,139,088	0.67%	329,232	—	329,232	0.00%
Metropolitan Thoroughfare District	49,139,088	1.33%	653,550	199,585	453,965	30.54%
Solid Waste Special Service District	46,053,015	2.00%	921,060	—	921,060	0.00%
Public Safety Communications and Computer Facilities District	49,139,088	0.67%	329,232	37,655	291,577	11.44%

(a) Excludes Revenue Bonds not payable from ad valorem taxes.

(b) There is no statutory constitutional debt limitation applicable to the Redevelopment District.

(c) Due to the extreme complexity of the taxing district structure, the City has not presented the required ten years of data as showing more than one year of data is extremely cumbersome. Previous years data can be found in the Comprehensive Annual Financial Reports from prior years.

**CITY OF INDIANAPOLIS**  
**Pledged Revenue Coverage**  
Schedule 15  
Last Ten Fiscal Years  
(In thousands)

Transportation revenue bonds						
Fiscal year	Wheel and gas tax revenue (a)	Debt service			Coverage	
		Principal	Interest			
2013	\$ 46,323	\$ 1,525	\$ 543		22.40	
2014	51,703	1,520	319		28.11	
2015	52,909	1,580	2,076		14.47	
2016	53,013	2,565	3,624		8.57	
2017	62,060	2,660	3,530		10.03	
2018	69,823	2,770	3,419		11.28	
2019	70,197	2,875	4,855		9.08	
2020	78,012	3,545	4,659		9.51 (l)	
2021	86,009	4,285	1,307		15.38	
2022	86,698	4,500	1,094		15.50	

PILOT revenue bonds					
Payments in lieu of taxes (b)	Debt service			Coverage	
	Principal	Interest (h)			
\$ 5,875	—	\$ 7,910		0.74	
3,771	—	7,910		0.48	
8,168	—	7,910		1.03	
8,168	—	7,910		1.03	
10,520	—	3,955		2.66 (j)	
13,729	—	7,413		1.85	
16,647	—	7,352		2.26	
18,908	2,790	7,352		1.86	
19,739	4,875	7,213		1.63	
20,152	5,115	6,969		1.67	

Property tax increment bonds					
Tax increment revenues (c)	Debt service			Coverage	
	Principal (d)	Interest			
\$ 82,754	\$ 29,701	\$ 17,729		1.74	
82,319	39,223	18,383		1.43	
83,953	34,815	18,673		1.57	
90,418	34,266	21,846		1.61 (i)	
81,848	33,538	15,002		1.69	
94,215	44,424	20,414		1.45	
109,540	51,484	20,098		1.53	
118,105	52,364	20,612		1.62	
123,491	58,500	19,939		1.57 (n)	
130,601	63,726	22,141		1.52 (o)	

Facilities revenue bonds					
Fiscal year	Charge back (e)	Debt service			Coverage
		Principal	Interest		
2013	\$ 1,535	\$ 1,365	\$ 575		0.79
2014	1,956	1,420	515		1.01
2015	1,952	1,450	249		1.15
2016	1,963	1,650	173		1.08
2017	1,855	1,680	131		1.02
2018	1,858	1,725	101		1.02
2019	1,840	1,750	70		1.01
2020	1,820	1,775	39		1.00
2021	1,819	905	8		1.99
2022	—	—	—		—

Economic development bonds					
Parking fees (f)	Debt service			Coverage	
	Principal	Interest			
\$ 1,004	\$ 255	\$ 749		1.00	
1,575	620	955		1.00	
3,164	1,183	1,981		1.00	
3,182	1,227	1,955		1.00	
2,364	957	1,407		1.00	
1,584	670	914		1.00	
1,584	685	899		1.00	
1,586	705	881		1.00	
1,583	720	863		1.00	
1,579	735	844		1.00	

Stormwater revenue bonds (m)					
Net revenues of the stormwater system (g)	Debt service			Coverage	
	Principal	Interest			
\$ 2,673	\$ 780	\$ 1,893		1.00	
3,985	1,665	2,320		1.00	
4,458	2,235	2,223		1.00	
5,280	1,990	2,234		1.25	
5,637	2,075	2,434		1.25	
7,539	3,730	2,301		1.25	
8,471	3,900	2,877		1.25 (k)	
11,379	4,095	5,008		1.25	
11,448	4,285	4,873		1.25	
12,927	4,495	5,846		1.25	

- (a) Wheel taxes and gasoline taxes are pledged.
- (b) Payments in lieu of taxes wastewater system.
- (c) Property tax increment revenues collected in TIF districts.
- (d) Does not include principal amount for refunding bonds.
- (e) Charge back to City-County agencies.
- (f) Fees from parking garage.
- (g) Improvements of stormwater handling capabilities.
- (h) Any shortfalls in pledged PILOT revenues are covered by accumulated PILOT payments from prior years.
- (i) Principal payment does not include \$52,485 for the Redevelopment District Refunding Bonds, 2016A (Marriott).
- (j) Principal payment does not include \$159,515 for the PILOT Refunding Bonds, Series 2017C.
- (k) Principal payment does not include \$50,000 for the Stormwater 2019 Refunding bonds.
- (l) Principal payment does not include \$104,360 for the IndyRoads Metropolitan Thoroughfare District Refunding Bonds, Series 2020B.
- (m) Revenue disclosed is equal to required coverage, actual coverage is higher.
- (n) Principal payment does not include \$78,915 for the Economic Development Bonds Series 2011A NOS.
- (o) Principal payment does not include \$25,845 for the Redevelopment District Refunding Bonds, Series 2022A (Refunding 2013) and \$ 16,135 Economic Development Tax Increment Refunding Revenue Bonds, Series 2022 B (Refunding 2013)

**CITY OF INDIANAPOLIS**  
**Demographic and Economic Statistics**  
Schedule 16  
Last Ten Fiscal Years

<u>Calendar year</u>	<u>Population (a)</u>	<u>Personal income (thousands of dollars) (b)</u>	<u>Per capita personal income (b)</u>	<u>Median age (a)</u>	<u>Education level in years of schooling (a)</u>	<u>School enrollment (c)</u>	<u>Unemployment rate (d)</u>
2013	844,696	\$ 42,029,249	\$ 45,197	33.90	12	149,697	7.00 %
2014	850,164	43,324,791	46,290	34.10	12	130,007	5.80
2015	853,714	45,335,677	48,238	34.30	12	130,371	4.60
2016	859,049	46,676,017	49,357	34.40	12	131,754	3.90
2017	863,478	47,727,002	50,211	34.50	12	132,596	3.10
2018	870,960	50,634,219	52,815	34.50	12	132,838	3.40
2019	876,384	52,478,123	54,405	34.20	12	131,292	2.90
2020	887,642	57,259,810	59,264	34.40	12	131,830	5.70
2021	880,621 (g)	63,729,003	65,625	34.40	12	127,552	1.90
2022	880,621 (f)	63,729,003 (e)	65,625 (e)	34.40 (f)	12	127,458	2.50

(a) U.S. Census Bureau

(b) Bureau of Economic Analysis

(c) Indiana Department of Education

(d) Bureau of Labor Statistics, December rate (not seasonally adjusted)

(e) This information was not made available by the Bureau of Economic Analysis as of the ACFR issuance date; therefore, prior year numbers were utilized.

(f) This information will be released by the U.S. Census Bureau at a future date; therefore, prior year numbers were utilized.

(g) This information is as of 7/1/2022

**CITY OF INDIANAPOLIS**  
**Principal Employers**  
Schedule 17  
December 31, 2022

<b>Employer</b>	<b>2022 (b)</b>			<b>Employer</b>	<b>2013 (c)</b>		
	<b>Employees</b>	<b>Rank</b>	<b>Percentage of total city employment (a)</b>		<b>Employees</b>	<b>Rank</b>	<b>Percentage of total city employment (a)</b>
Indiana University Health	23,187	1	4.72%	Indiana University Health	20,292	1	4.69%
Ascension St. Vincent	17,398	2	3.55%	St Vincent Hospitals & Health Services	11,075	2	2.56%
Community Health Network	15,000	3	3.06%	Eli Lilly and Company	10,500	3	2.42%
IUPUI	14,000	4	2.85%	Wal-Mart	9,000	4	2.08%
Eli Lilly and Company	11,279	5	2.30%	Marsh Supermarkets	8,890	5	2.05%
Walmart	9,582	6	1.95%	Community Health Network	8,100	6	1.87%
Kroger Co	7,520	7	1.53%	Indianapolis Public Schools	6,123	7	1.41%
Federal Express Corporation	5,800	8	1.18%	Fed Ex Express	6,000	8	1.39%
Anthem	4,870	9	0.99%	Franciscan St. Francis Health	5,576	9	1.29%
Meijer	4,707	10	0.96%	IUPUI	5,100	10	1.18%

- (a) Percentage of total City employment is calculated by using total Employed Labor Force, which can be found at [www.stats.indiana.edu](http://www.stats.indiana.edu).
- (b) Largest employers obtained from Indy Partnership.
- (c) Data presented as originally published in the 2013 Comprehensive Annual Financial Report.

**CITY OF INDIANAPOLIS**  
**Full-Time Equivalent City Government Employees by Function/Program**  
 Schedule 18  
 Last Ten Fiscal Years

	<u>2013</u>	<u>2014</u>	<u>2015</u>	<u>2016</u>	<u>2017</u>	<u>2018</u>	<u>2019</u>	<u>2020</u>	<u>2021</u>	<u>2022</u>
<b>General Government</b>	211	200	192	190	195	194	199	190	191	183
<b>Protection of People</b>										
Police Department	1,527	1,549	1,654	1,647	1,654	1,653	1,660	1,628	1,684	1,573
Fire Department	1,155	1,173	1,180	1,184	1,184	1,179	1,189	1,192	1,256	1,214
Other (Civilian)	348	336	337	331	340	342	392	379	362	312
<b>Public Works</b>	620	626	632	648	649	684	694	713	681	631
<b>Parks and Recreation</b>	99	103	103	104	117	119	123	119	183	127
<b>Redevelopment</b>	<u>204</u>	<u>226</u>	<u>237</u>	<u>239</u>	<u>254</u>	<u>247</u>	<u>251</u>	<u>231</u>	<u>211</u>	<u>217</u>
<b>Total full-time City employees</b>	<u><u>4,164</u></u>	<u><u>4,213</u></u>	<u><u>4,335</u></u>	<u><u>4,343</u></u>	<u><u>4,393</u></u>	<u><u>4,418</u></u>	<u><u>4,508</u></u>	<u><u>4,452</u></u>	<u><u>4,568</u></u>	<u><u>4,257</u></u>

Note: A full-time employee is scheduled to work 2,080 hours per year (including vacation and sick leave). Full-time equivalent employment is calculated by dividing total labor hours by 2,080.

Source: City of Indianapolis Office of Finance & Management

**CITY OF INDIANAPOLIS**  
**Operating Indicators by Function/Program**  
Schedule 19  
Last Ten Fiscal Years

<b>Function/program</b>	<b>2013</b>	<b>2014</b>	<b>2015</b>	<b>2016</b>	<b>2017</b>	<b>2018</b>	<b>2019</b>	<b>2020</b>	<b>2021</b>	<b>2022</b>
<b>General government</b>										
Total permits issued	38,384	39,708	37,967	38,117	42,140	43,962	47,513	40,146	43,589	46,897
Building inspections conducted	29,891	31,026	40,088	37,681	37,645	35,875	37,400	29,241	24,004	16,111
Households assisted with entitlement grants	2,233	2,100	4,219	6,812	6,436	2,193	1,496	2,099	2,846	4,144
<b>Police</b>										
Physical arrests	52,337	42,293	39,417	61,059	41,310	32,578	15,466 (c)	22,720	22,458	19,550
Parking violations	2,362	3,440	6,512	7,501	7,599	6,827	6,971	6,838	7,442	8,598
Traffic violations	36,953	31,684	40,642	49,921	35,915	35,062	39,016	28,781	29,019	32,136
<b>Fire</b>										
Emergency responses	150,535	97,140	106,118	164,030	178,522	167,217	161,339	155,449	164,296	163,047
Dispatched fire runs	18,744	18,543	18,809	15,145	15,526	16,793	19,628	19,534	18,471	22,604
Inspections	10,960	15,228	17,678	14,049	13,687	14,398	11,436	11,297	15,957	15,926
<b>Refuse collection</b>										
Refuse collected (tons per day)	960	975	991	1,044	1,127	765	787	873	855	792
Leaves collected (tons per year)	6,359	5,785	5,397	3,789	3,842	4,894	4,880	5,458	3,862	3,664
<b>Other public works</b>										
Street resurfacing (miles)	178	254	138	157	72	114	237	147	123	90
Pothole work orders completed (a)	14,512	21,722	24,106	21,954	24,202	43,731	45,454	32,060	22,578	34,702
<b>Parks and recreation</b>										
Number of shelter rental reservations	2,176	2,097	2,467	2,208	2,263	2,865	3,039	1,403 (b)	2,773	3,166
Number of day camp registrations	3,107	3,213	3,226	3,077	3,010	3,079	3,492	428 (b)	488 (b)	3,002
Community park and facility attendance	7,844,919	5,172,493	7,460,471	8,648,601	8,456,535	8,393,228	8,936,017	7,499,379 (b)	8,185,883	8,291,341

(a) Work order can consist of one pothole or multiple potholes.

(b) Reduction due to COVID-19 pandemic and related restrictions.

(c) Represents physical arrests from June through December 2019, January through May is not available.

Sources: Various City departments



**CITY OF INDIANAPOLIS**  
**Capital Asset Statistics by Function/Program**  
Schedule 20  
Last Ten Fiscal Years

<b>Function/program</b>	<b>2013</b>	<b>2014</b>	<b>2015</b>	<b>2016</b>	<b>2017</b>	<b>2018</b>	<b>2019</b>	<b>2020</b>	<b>2021</b>	<b>2022</b>
<b>Public Safety</b>										
Police stations	6	6	6	6	6	6	6	6	6	6
Police and emergency management vehicles and other rolling stock	1,925	1,838	1,916	2,009	2,029	2,069	2,128	2,131	2,234	2,161
Fire stations	44	44	44	43	43	43	43	43	44	44
Fire vehicles and other rolling stock	276	276	291	296	305	315	328	316	316	330
Animal control vehicles and other rolling stock	34	30	33	33	33	32	41	36	36	33
<b>Other Public Works</b>										
Streets (miles)	3,307	3,323	3,337	3,339	3,339	3,342	3,401	3,402	3,352	3,356
Sidewalks (miles)	3,097	3,199	3,224	3,247	3,251	3,252	3,151	3,152	3,158	3,165
Bridges	541	541	540	538	539	539	539	538	538	541
Traffic signal installations	1,132	1,136	1,141	1,147	1,147	1,151	1,156	1,163	1,164	1,164
Miles of storm sewers and drainage	1,536	1,540	1,544	1,545	1,550	1,552	1,561	1,564	1,573	1,581
Public works vehicle and other rolling stock	652	644	605	590	593	682	721	665	643	612
<b>Cultural and Recreation</b>										
Parks	207	208	208	207	210	210	218	218	214	214
Park properties – acreage	11,161	11,186	11,186	11,254	11,254	11,254	11,386	11,386	11,348	11,608
Playgrounds	126	126	126	125	125	126	126	130	130	130
Golf courses	13	13	13	13	13	13	13	12	12	12
Swimming pools – outdoors	16	16	16	16	18	18	18	18	18	16
Swimming pools – indoors	5	5	5	5	4	4	4	4	4	4
Recreational centers	24	24	24	23	23	23	23	23	23	23

Sources: Various City departments

**(This page intentionally left blank)**